

LODES

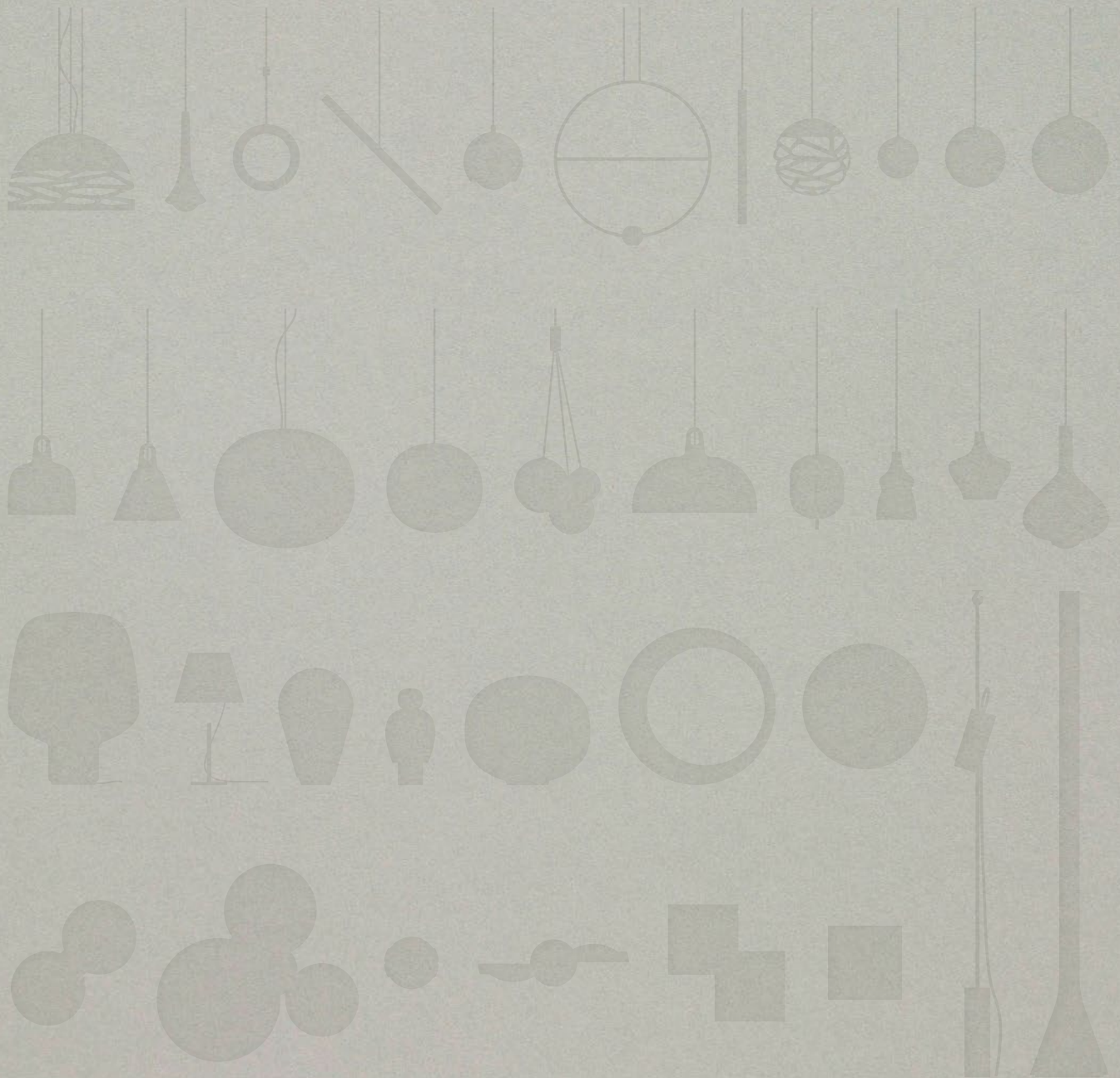

Pag.	Product name	Category
084	A A-Tube	Cluster suspension lamp, Ceiling lamp
056	A-Tube Nano	Cluster suspension lamp
074	A-Tube Nano Duo	Cluster suspension lamp
354	Aile	Wall lamp
298	B Blow	Table lamp
404	Bugia	Ceiling lamp
318	C Cima	Suspension lamp, Floor lamp
304	Croma	Floor lamp
288	E Easy Peasy	Cordless table lamp
022	Elara	Suspension lamp
264	F Flar	Table lamp, Floor lamp
274	H Hover	Table lamp, Floor lamp
038	I IVY I	Cluster suspension lamp
038	IVY V	Suspension lamp, Central cluster suspension lamp
228	J Jefferson	Cluster suspension lamp
150	JIM	Cluster suspension lamp, Suspension lamp
134	K Kelly	Suspension lamp, Wall lamp
124	Kelly Cluster	Cluster suspension lamp
418	L Laser	Wall lamp
424	M Make-Up	Wall lamp, Ceiling lamp
338	N Nautilus	Ceiling lamp, Wall lamp
338	Nautilus Mini	Wall lamp
238	Nostalgia	Cluster suspension lamp
412	P Pin-Up	Wall lamp, Ceiling lamp
388	Puzzle	Wall lamp, Ceiling lamp
362	Puzzle Mega	Wall lamp, Ceiling lamp
396	Puzzle Outdoor	Wall lamp
378	Puzzle Round	Wall lamp, Ceiling lamp
094	R Rain	Cluster suspension lamp
188	Random	Cluster suspension lamp
204	Random Solo	Cluster suspension lamp
252	S Sky-Fall	Suspension lamp
108	Spider	Cluster suspension lamp, Ceiling lamp
328	T Tidal	Ceiling lamp
162	V Volum	Cluster suspension lamp, Suspension lamp, Wall lamp, Ceiling lamp, Table lamp

Lodes – Standard tools, bespoke solutions

Balancing innovative technical know-how and the essence of Italian design, Venice-based Lodes has been designing and producing *lighting solutions* for interiors and exteriors since 1950. Thanks to the use of materials of the highest quality, Lodes' products are *premium lighting* that prioritise the *relationship with the user* and suit most needs and moods – with proprietary LED modules as well as versatile standard light sources.



002



003



004



001

Lodes – Strumenti universali per soluzioni personalizzate

Coniugando design contemporaneo e tecnologia di punta, l'azienda veneziana Lodes progetta e produce *soluzioni d'illuminazione* d'arredo d'interni ed esterni dal 1950. Grazie all'impiego di materiali di altissima qualità, i prodotti Lodes sono soluzioni illuminotecniche di eccellenza che privilegiano *l'interazione con l'utente finale* e in grado di soddisfare ogni esigenza e mood d'arredo anche grazie a esclusivi moduli LED e a fonti luminose standard particolarmente versatili.

001 Headquarters Marcon, Venice
002 Andrea Tosetto, President
003 Massimiliano Tosetto, Managing Director
004 Warehouse Marcon, Venice

MASTERY

Originating in founder's passion for glass, Lodes represents a three-generation evolution from pure passion to brilliant lighting solutions. Today, Lodes favours durable materials that can be moulded at will, to suit specific design visions and best serve each project. Glass and metal celebrate the company's manufacturing know-how and its high-quality essence.

MAESTRIA

Nata dalla passione per il vetro del fondatore, Lodes racconta un percorso evolutivo attraverso tre generazioni, dalla pura passione alle soluzioni illuminotecniche più originali. L'azienda veneziana opta per materiali durevoli da plasmare a piacimento in funzione delle specifiche esigenze di design di ogni singolo progetto. È così che il vetro e il metallo celebrano il know-how produttivo e la qualità di Lodes.



007



008

005-6 Metal manufacturing know-how
007-8-9 Glass manufacturing know-how



005



006



009



Designers

The collaborations with international designers consolidate the company's commitment to distinctive decorative design, continuous development, and experimentation. Lodes' workshop is the place where technical know-how meets new creative perspectives, where designers' creative ideas are shaped and elaborate sketches give life to new product stories.

Le collaborazioni con designer internazionali consolidano l'impegno dell'azienda a creare soluzioni decorative uniche, frutto di continue ricerche e sperimentazioni. L'officina Lodes è il luogo di incontro tra know-how tecnico ed estro in cui le idee creative dei designer prendono forma e schizzi elaborati generano inedite narrazioni di prodotto.

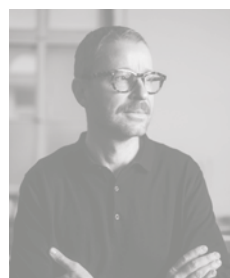

Marco Dessì



Chia-Ying Lee

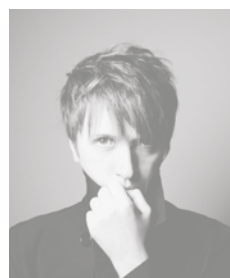

Dima Loginoff

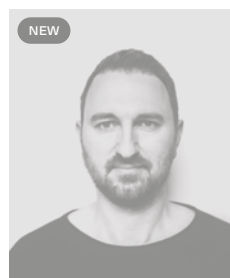

Vittorio Massimo

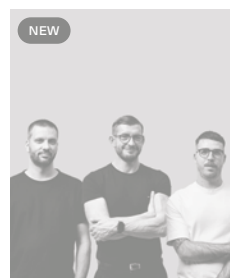

Needs Studio



Luca Nichetto



Patrick Norguet

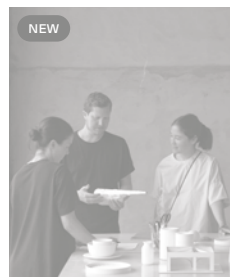

Snøhetta



Studio Italia Design



Andrea Tosetto



Pio & Tito Toso



YOY

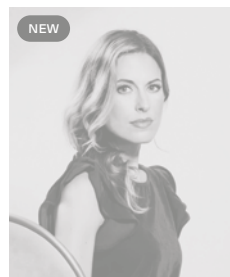

Nika Zupanc

Marco Dessì
Chia-Ying Lee
Dima Loginoff
Vittorio Massimo
Needs Studio
Luca Nichetto
Patrick Norguet
Snøhetta
Studio Italia Design
Andrea Tosetto
Pio & Tito Toso
YOY
Nika Zupanc

MARCO DESSÌ
Studio *Marco Dessì* is a multidisciplinary design studio based in Vienna. The studio's approach is practical and collaborative, where design is understood as an interactive process. Dessì's studio is not committed to any particular style, preferred material or unified formula, but rather regards designing as a trade characterised by a deep understanding of materials, processes and how the two are linked. The way in which an object is produced has a direct influence over its aesthetic appearance and the story that it tells. In his work, *Marco Dessì* values transparency in terms of a consistent link between the process of designing and the actual conditions of production. ● EN

Marco Dessì è uno studio di design multidisciplinare con sede a Vienna. Adottando un approccio pratico e collaborativo, lo studio concepisce il design come un processo interattivo. Lo studio Dessì non si ispira ad uno stile specifico né predilige un materiale o si basa su una formula universale, bensì si dedica alla progettazione come attività caratterizzata da una profonda comprensione dei materiali, dei processi e del legame tra tali elementi. Il modo in cui un oggetto viene prodotto incide direttamente sulla sua estetica e sulla storia che racconta. Per questo, nei propri lavori *Marco Dessì* fa della trasparenza il nesso coerente tra il processo di progettazione e le effettive condizioni produttive. ● IT

CHIA-YING LEE



Chia-Ying Lee was born in Taiwan and became a designer in new media and industrial design after study. She graduated from the Interaction Design Institute Ivrea in 2006. After working for PEGA Design & Engineering, she set up studio if in 2011. Her work is a blend of design, art and technology embodied in physical forms, from products to installations. Studio if also runs small production of her works for stores and galleries in Europe and Asia. Her projects have won various awards including "IF China Product Design Award", "Taiwan Excellence Award" and "SDA Best Design of The Year". She was selected as one of the IFFS Asian Star Talents in 2015. That same year she designed for Lodes. ● EN

Chia-Ying Lee è nata a Taiwan e, dopo gli studi, è diventata progettista di design industriale e new media. Laureata all'Interaction Design Institute di Ivrea nel 2006, ha lavorato per PEGA Design & Engineering, per poi fondare lo studio if nel

2011. Il suo lavoro è una fusione di design, arte e tecnologia incarnata in forme fisiche, dai prodotti alle installazioni. Lo studio if realizza anche piccole produzioni delle sue opere per negozi e gallerie in Europa e Asia. I suoi progetti hanno vinto diversi premi tra cui "IF China Product Design Award", "Taiwan Excellence Award" e "SDA Best Design of The Year". Nel 2015 è stata selezionata tra i talenti asiatici all'IFFS. Nello stesso anno ha progettato per Lodes. ● IT

DIMA LOGINOFF

Dima Loginoff was born in 1977 in Moscow, where in 1997 he graduated from the College of Hairdresser's Art and then worked as a designer for over 10 years. In 2008 he graduated with distinction from the International Design School in Moscow and the Rhodex International Interior Design School in London. Over time he has received important awards including the "Grand Prix Award" in 2007, the "Young Designer of the Year-2010" by Elle Magazine, the "Twelve Golden" by the Russian magazine Interior + Design, several publications in magazines around the world. Today, in addition to new projects, *Dima Loginoff* teaches in specialisation courses and holds design seminars. For Lodes she designed the acclaimed suspension lamp. ● EN

Dima Loginoff è nato nel 1977 a Mosca, dove nel 1997 si è laureato al College of Hairdresser's Art e poi ha lavorato come stilista per oltre 10 anni. Nel 2008 si è laureato con merito alla International Design School di Mosca e alla Rhodex International Interior Design School di Londra. Nel tempo ha ricevuto importanti riconoscimenti tra cui il "Grand Prix Award" nel 2007, il "Young Designer of the Year-2010" di Elle Magazine, il "Twelve Golden" della rivista russa Interior + Design, diverse pubblicazioni su riviste di tutto il mondo. Oggi, accanto a nuovi progetti, *Dima Loginoff* insegna in corsi di specializzazione e tiene seminari di design. Per Lodes ha progettato l'acclamata sospensione. ● IT

VITTORIO MASSIMO

Architect *Vittorio Massimo* was born in Treviso in 1981. In 2007 he began a three-year collaboration with John Pawson Architects in London and with MZC+ in Treviso until 2017. Meanwhile, he continues his professional activity with private commissions and participates and wins several awards in national and international competitions. In 2020 the project for the Maison 203 showroom was included in the first list of architectures nominated for the Archdaily best building of the year award and in 2021 he was among the winners of the Big See award with the same project. He works in parallel in product design and lighting design, and in 2014 he won the Chicago Athenaeum Good Design Award. ● EN

L'architetto *Vittorio Massimo* nasce a Treviso nel 1981. Dal 2007 inizia una collaborazione di tre anni con lo studio John Pawson Architects e con lo studio MZC+, che prosegue fino al 2017. Parallelamente segue la propria attività professionale con incarichi privati e partecipando e vincendo diversi premi in concorsi nazionali e internazionali. Nel 2020 il progetto per lo showroom Maison 203 rientra nella prima lista di architetture nominate per il premio di miglior edificio dell'anno per Archdaily e nel 2021 è tra i vincitori, con lo stesso progetto, del Big See award. Lavora parallelamente nell'ambito del design di prodotto e nel lighting design, e nel 2014 vince il Chicago Athenaeum Good Design Award. ● IT



NEEDS STUDIO *Needs* is an Italian product design studio founded in 2020 by Davide Gerlin, Marco Brunato, and Matteo Coracin. Their vision of design is focused on the ability to find solutions to customer needs, maintaining a style that is a bridge between the nature of the brand and their sensitivity. Their method leads them to investigate first what it may be logical to enter the market for a specific brand, a product research that is influenced and matures on each project, a result that is not only the outcome of a clear style but rather a mixture of points of view. *Needs'* goal is to create objects that are identifiable in their uniqueness, that speak of the brand for which they were shaped, and that reflect the values of the studio. ● EN

Needs è uno studio italiano di product design fondato nel 2020 da Davide Gerlin, Marco Brunato e Matteo Coracin. La loro visione del design è focalizzata sulla capacità di trovare soluzioni alle esigenze del cliente, mantenendo uno stile che fa da ponte tra la natura del brand e la sensibilità dello studio. Il loro metodo li porta ad indagare cosa può essere inserito nel mercato per un determinato brand. Una ricerca di prodotto che viene maturata per ogni progetto, originando un risultato che è il frutto di una fusione di punti di vista. L'obiettivo di *Needs* è creare oggetti che siano identificabili nella loro unicità, che parlino dell'azienda per cui sono stati plasmati, rispecchiando i valori dello studio. ● IT

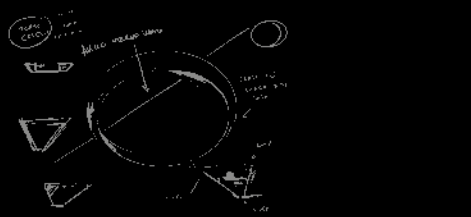

LUCA NICHETTO Multidisciplinary designer *Luca Nichetto* was born in 1976 in Venice. He studied at the city’s Istituto Statale d’Arte and Università IUAV di Venezia, graduating in 1998. Luca setup Nichetto Studio in 2006 in Venice. Five years later he moved to Stockholm to start his family and open a second studio. He has lectured at several universities and has sat on juries for international design competitions. His work is often featured in exhibitions worldwide and has been the subject of retrospectives worldwide. Nichetto’s projects have earned him an array of awards for designs that range from products, accessories and furniture to architecture, exhibition design and branding. ● EN

Il designer multidisciplinare *Luca Nichetto* nasce a Venezia nel 1976. Intraprende gli studi all’Istituto Statale d’Arte della città per poi iscriversi all’Università IUAV, dove si laurea nel 1998. Nel 2006 fonda Nichetto Studio a Venezia e cinque anni dopo si trasferisce a Stoccolma, dove mette su famiglia e apre il secondo studio. Le sue opere, spesso esibite in prestigiose esposizioni di respiro internazionale, sono state oggetto di mostre retrospettive in tutto il mondo. I progetti firmati Nichetto hanno ricevuto numerosi riconoscimenti nell’ambito del design, spaziando dai prodotti, agli accessori e complementi d’arredo fino all’architettura, agli allestimenti espositivi e al branding. ● IT



PATRICK NORGUET *Patrick Norguet* approaches objects and design from a graphical perspective. A “hands-on” approach of industry and design studies in Paris (ESDI) mark the unusual profile of this constructive rebel. Drawing inspiration from everything that surrounds him, *Patrick Norguet* does not follow trends but seeks to give shape to products whose relevance and modernity would withstand the test of time: “A well-designed object, an object created through generous collaboration is timeless.” From consumer products to luxury objects, *Patrick Norguet* leaves an impression of authenticity and elegance. Today, he is an essential figure on the international design scene. ● EN

Patrick Norguet si avvicina agli oggetti e al design da una prospettiva grafica. Un approccio “pratico” agli studi industriali e di design a Parigi (ESDI) segna il profilo insolito di questo ribelle costruttivo. Traendo ispirazione da tutto ciò che lo circonda, *Patrick Norguet* non segue le tendenze, ma

cerca di dare forma a prodotti la cui attualità e modernità possano resistere alla prova del tempo: “Un oggetto ben progettato, un oggetto creato grazie a una collaborazione generosa è senza tempo”. Dai prodotti di consumo agli oggetti di lusso, il designer lascia un’impressione di autenticità ed eleganza. È oggi una figura essenziale nel panorama del design internazionale. ● IT

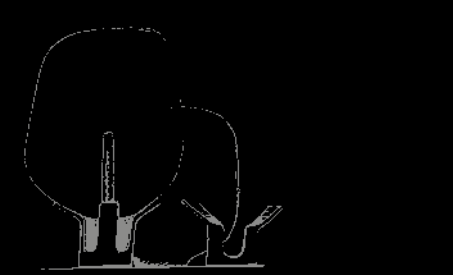

SNØHETTA *Snøhetta* has grown to become one of the most internationally renowned Architecture & Design practices globally. The practice began as a collaborative architectural and landscape workshop in 1989 and has remained true to its multi-disciplinary way of thinking until this day. Museums, product developments, reindeer observatories, visual universes and virtual landscapes all get the same care and attention. Since then, *Snøhetta* has introduced specialised disciplines to enhance our capabilities and reach. These disciplines act at the forefront of sustainable and social innovation. Even with a primarily international approach and staff, *Snøhetta* has maintained a strong and unified culture that is well-rooted within the Nordic model. ● EN

Snøhetta si è affermato tra gli studi di architettura e design più rinomati a livello internazionale. Nato nel 1989 come laboratorio collaborativo di architettura e del paesaggio, lo studio è rimasto sempre fedele al proprio approccio multidisciplinare. Dai musei, agli sviluppi di prodotto, dagli osservatori di renne agli universi visivi fino ai paesaggi virtuali, ogni elemento merita la stessa cura e attenzione. Da allora *Snøhetta* ha introdotto specifiche discipline che, perseguendo lo scopo di potenziare capacità e possibilità, aprono la strada all’innovazione. Nonostante il carattere internazionale, *Snøhetta* ha mantenuto una solida cultura unificata ben radicata nel modello nordico. ● IT



STUDIO ITALIA DESIGN Very often teamwork generates winning ideas. This has been the experience for *Studio Italia Design*, a creative workshop that brings together different intuitions and gives shape to the ideas of the company’s own people-technical and creative staff, insiders who know the sector deeply. The results of the synergy of craft, curiosity and speed, contaminated by the endless energy of Andrea Tosetto, are firmly established success stories, like the suspension lamp *Sky-Fall*, or the *A-Tube* and *Puzzle* collections. ● EN

Dal lavoro di squadra nascono molto spesso idee vincenti. È questa l’esperienza di *Studio Italia Design*, un laboratorio creativo che accoglie le intuizioni e dà forma alle idee delle persone dell’azienda, tecnici, creativi, conoscitori del settore. I risultati della sinergia di mestiere, curiosità e velocità, contaminati dall’energia inesauribile di Andrea Tosetto, sono storie di successo ormai consolidate, come la lampada a sospensione *Sky-Fall* e le collezioni *A-Tube* e *Puzzle*. ● IT

ANDREA TOSETTO *Andrea Tosetto* studied at the Art High School and at the Accademia delle Belle Arti in Venice. At the age of 18, he joined the company founded by his father Angelo in 1950, which he soon took over. Andrea marks the transition of the company from the classical lines of that time to an innovative and more contemporary language. His dynamic entrepreneurial style and lively creative vein come to life in refined products that enhance the craftsmanship method. Andrea succeeded in emphasising the company’s know-how, focusing on the internalisation of production processes and on the use of quality materials with a strong bond with the Venetian territory. *Kelly* and *Nautilus*, are just some of Andrea’s creations for Lodes. ● EN

Andrea Tosetto si forma al Liceo Artistico e all’Accademia delle Belle Arti di Venezia. A 18 anni entra a far parte dell’azienda fondata dal padre Angelo nel 1950, di cui presto prenderà le redini. Andrea segna il passaggio dell’azienda dalle linee classiche dell’epoca ad un linguaggio innovativo e più contemporaneo. Il suo stile imprenditoriale dinamico e la sua vena creativa vivace prendono forma in prodotti curati che esaltano il sistema di lavorazione artigianale. Andrea ha saputo dare protagonismo al saper-fare dell’azienda, mirando all’internalizzazione dei processi di produzione e all’utilizzo di materiali di qualità con un forte legame con il territorio veneziano. *Kelly* e *Nautilus*, sono solo alcune delle creazioni di Andrea per Lodes. ● IT

PIO & TITO TOSO

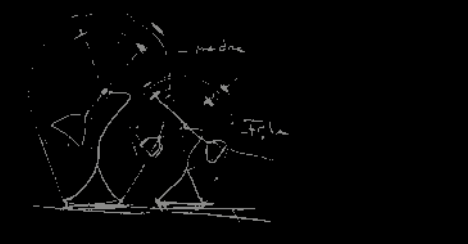

Pio and Tito are brothers, born in 1973 and 1971 in Venice, where they graduated in Architecture in 1998. In 1996 they founded their design studio *Pio & Tito Toso*. The Studio works on architecture projects in Italy and abroad, and takes parts in numerous contests. In the field of industrial design the Toso brothers boast projects with the most qualified lighting and furniture companies. The list of awards they received includes Design Plus Award 2016, Red Dot Design Award 2015, Red Dot Design Award 2012 Good Design Award 2009, I.Dot selection 2006–2007, Young & design 2005. They have participated in exhibitions in Europe and the United States. ● EN

I fratelli Pio e Tito nascono nel 1973 e nel 1971 a Venezia dove si laureano in architettura nel 1998. Nel 1996 aprono lo studio di progettazione *Pio & Tito Toso*. Lavorano nel campo dell’architettura realizzando numerosi progetti sul territorio nazionale ed internazionale e partecipano a vari concorsi. Nel campo del design industriale vantano collaborazioni con le aziende più qualificate nell’illuminazione e nell’arredo. La lista dei riconoscimenti che hanno ricevuto include Design Plus 2016, Red Dot Design Award 2015, Red Dot Design Award 2012, Good Design Award 2009, selezione I.Dot 2006–2007, Young & design 2005. Hanno partecipato a mostre in Europa e Stati Uniti. ● IT

YOY Established in 2011, YOY is a design studio by Naoki Ono and Yuki Yamamoto, based in Tokyo and working internationally. They design mainly furniture, lighting and interiors around the theme of “between space and objects”. The products pursue aspects of design that go beyond ease of use and functionality. *YOY* first presented their independent works at Milan Design Week 2012 and have since participated in the event for eight consecutive years. Their works have now been commercialized by European and American brands. Their works are sold all over the world including MoMA, and they have received several international awards. ● EN

Fondato nel 2011 da Naoki Ono e Yuki Yamamoto, YOY è uno studio di design con sede a Tokyo e operante a livello internazionale. Il tema centrale che caratterizza il loro design, è l’analisi del rapporto “tra spazio e oggetto”

nel progettare arredi, illuminazione e spazi interni. I prodotti perseguono aspetti del design che vanno oltre la facilità d’uso e la funzionalità. Gli YOY hanno presentato per la prima volta i loro lavori alla Milano Design Week del 2012 e da allora hanno partecipato all’evento per otto anni consecutivi. I loro lavori sono stati messi in vendita da brand europei e americani. I loro lavori sono venduti in tutto il mondo, incluso il MoMA, e hanno ricevuto numerosi premi internazionali. ● IT

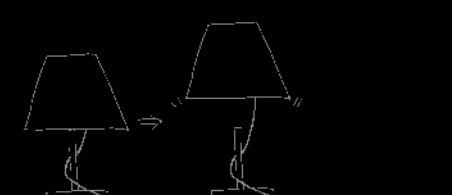

NIKA ZUPANC After graduating with honour in 2000 at the Academy of Fine Arts and Design, Department of Industrial design in Ljubljana, the Slovenian product and interior designer *Nika Zupanc* became a globally recognised name with the launch of her first object in 2007. In 2008, she established her own eponymous studio in her hometown of Ljubljana and since works as an independent designer constantly involved in projects that grow out of distinctive interpretations of modern culture, contemporary design and available technological options. Her visual language comes from deep within and is about “communicating the things that cannot be told.” ● EN

Dopo essersi laureata con lode nel 2000 presso Academy of Fine Arts and Design, in Industrial Design a Lubiana, la product e interior designer slovena *Nika Zupanc* è diventata un nome riconosciuto a livello mondiale con il lancio del suo primo oggetto prodotto su larga scala nel 2007. Nel 2008 ha fondato l’omonimo studio nella sua città natale, Lubiana, e da allora lavora come designer indipendente, costantemente coinvolta in progetti che nascono da interpretazioni distintive della cultura moderna, del design contemporaneo e delle varie tecnologie disponibili. Il suo linguaggio visivo nasce dal profondo e si propone di “comunicare le cose che non possono essere raccontate”. ● IT

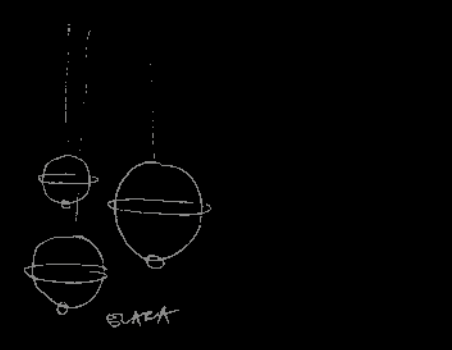

Canopy Systems

1	Single Mini	047 060 152 216
2	Recessed Micro	044 058 068 102 176 192 194 199 210 214 240
3	Single Standard	
4	Wall Standard	243

The freedom offered by Lodes' canopies brings to life the concept of "standard bespoke" which characterises the collection, a selection of products which are universal yet particular to each client's needs. Smart functional solutions as well as stand-out decorative elements, canopies provide an array of possibilities to personalise any living spaces, whether residential or public.

La libertà offerta dai rosoni Lodes dà vita al concetto di "standard su misura" che contraddistingue la collezione: una selezione di prodotti che, nonostante il carattere universale, rispondono alle esigenze specifiche di ogni cliente. I rosoni Lodes si presentano come soluzioni funzionali e insieme elementi decorativi differenzianti che garantiscono una miriade di possibilità di personalizzazione degli spazi abitativi, residenziali e pubblici.

Single canopies

Single

Lodes offers canopies to suit every project. *Single canopies* are ideal for highlighting the corner of a room or enhancing single light sources. They can also be used to create multiple custom combinations on high ceilings or in spaces which do not allow lights to be grouped in a cluster.

Lodes propone rosoni in grado di adattarsi ad ogni progetto. I *rosoni singoli* si prestano ad enfatizzare gli angoli di una stanza o a valorizzare singoli corpi luce. Inoltre, possono essere impiegati per creare composizioni multiple personalizzate su soffitti molto alti o in situazioni che non consentono l'utilizzo di cluster.



Cluster suspension lamps:

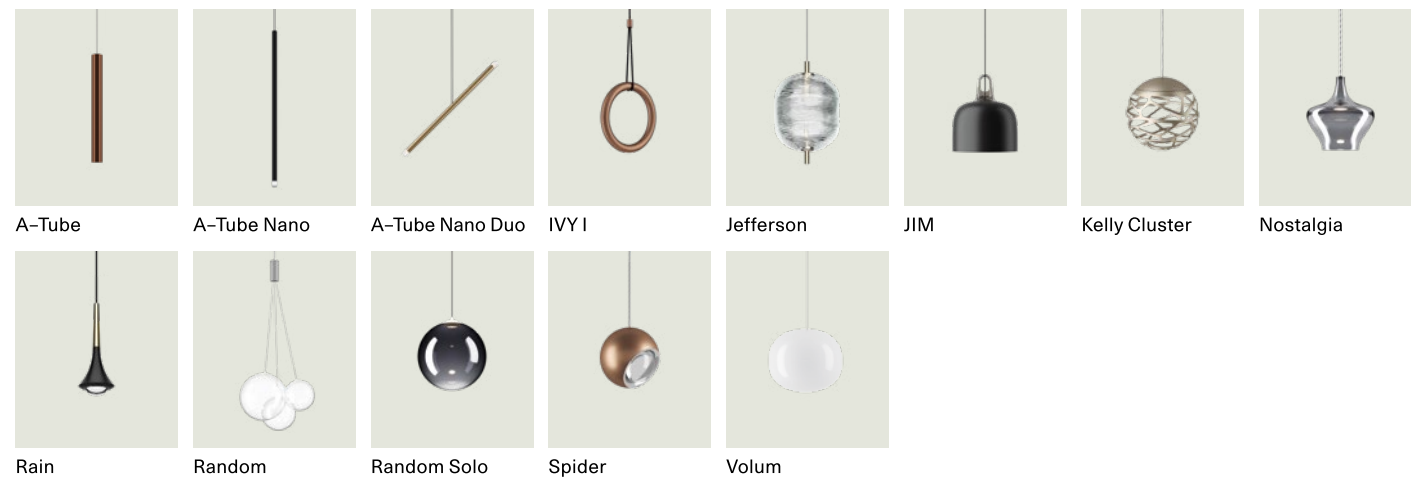

Multiple canopies

Round and Rectangular

For an impactful lighting effect *multiple canopies*, round or rectangular, are functional systems to create suspended compositions with a variable but predefined number of holes.

Per un'illuminazione di grande impatto, i *rosoni multipli*, rotondi o rettangolari sono sistemi funzionali che permettono di creare composizioni sospese con un numero di fori variabile ma predefinito.

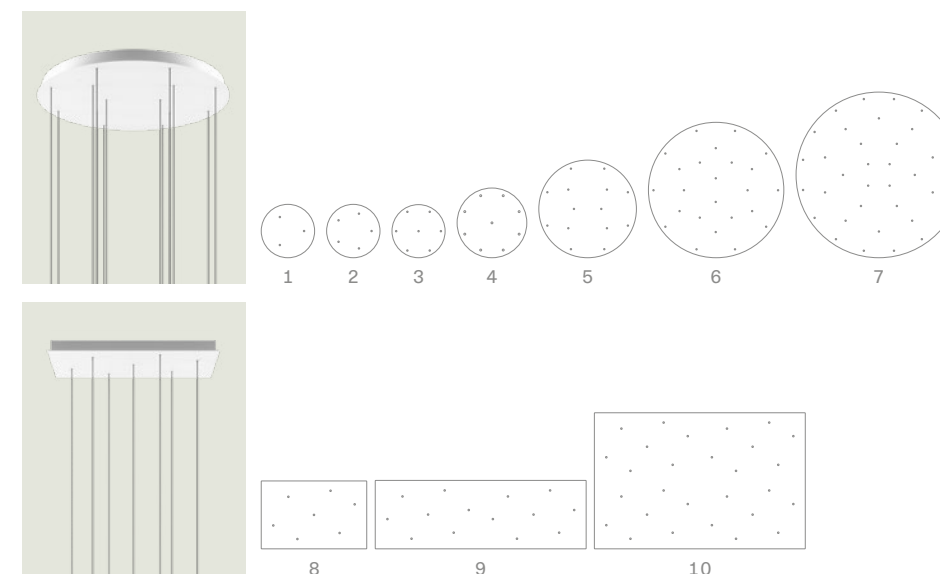

1	3 Lights Round	085 155 174
2	5 Lights Round	057 062 102 216 234
3	7 Lights Round	075
4	9 Lights Round	210
5	14 Lights Round	130 212
6	24 Lights Round	078 096 246
7	36 Lights Round	042 077 154 197
8	7 Lights Rectangular	194
9	14 Lights Rectangular	064 244
10	28 Lights Rectangular	066

Multiple canopies

Radial

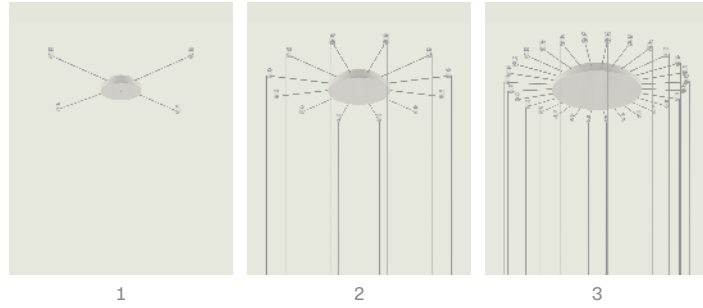

1	1-4 Lights Radial	114 116 118
2	5-12 Lights Radial	114 120 128 198
3	13-28 Lights Radial	

Alternatively, *radial systems* are an innovative way to separately manage various suspension cables starting from one single canopy, this is a particularly useful way to illuminate spaces with irregular ceilings.

In alternativa, i *sistemi radiali* rappresentano una soluzione innovativa per gestire separatamente diversi cavi di sospensione a partire da un unico rosone, rivelandosi particolarmente utili per illuminare ambienti con soffitti irregolari.

Track

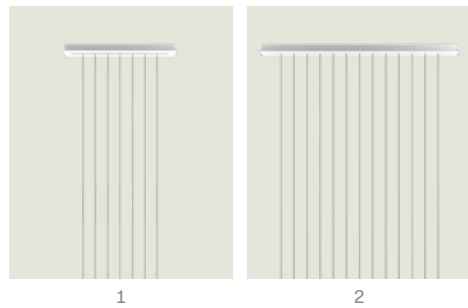

1	Short Lights Track	045 100
2	Long Lights Track	088 190 219

Meanwhile, *track systems* offer various possibilities of in-line composition with a variable number of lamps depending on the preferred type of installation, for example in projects which require height-aligned or staggered suspensions.

I *sistemi a binario* offrono molteplici possibilità di composizione in linea con un numero variabile di lampade a seconda del tipo di installazione desiderato, ad esempio in caso di progetti che prevedono sospensioni allineate in altezza o sfalsate.

Configurator



Jefferson, Single Mini

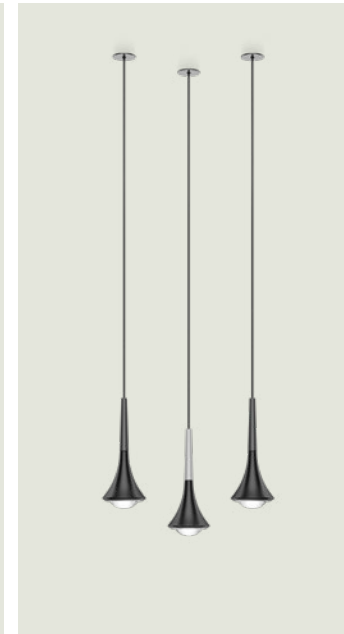

Rain, Recessed Micro



JIM, 14 Lights Round

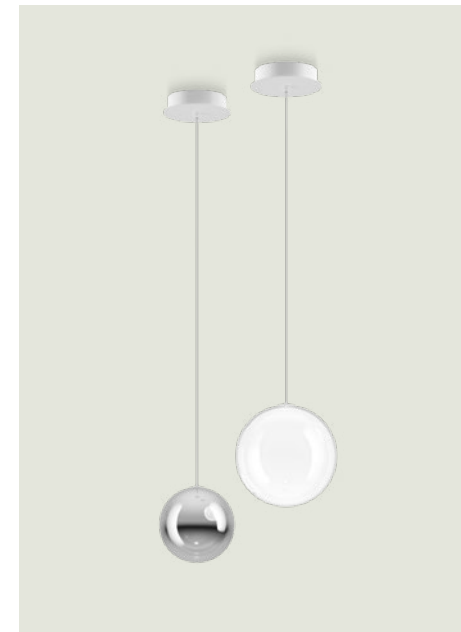

Random Solo, Single Standard

Lodes' product configurator offers endless opportunities to create personalised canopy lighting. Users of the configurator tool can choose a *suspension lamp* and combine this with a *canopy*, to create a piece that works with a multitude of decorative and functional lighting requirements.

Il configuratore di prodotto Lodes offre infinite possibilità per creare un'illuminazione personalizzata con i rosoni Lodes. Il configuratore permette di selezionare una *lampada a sospensione* e di combinarla con un *rosone* a scelta per creare un pezzo unico in grado di soddisfare una varietà di bisogni e desideri decorativi e funzionali.

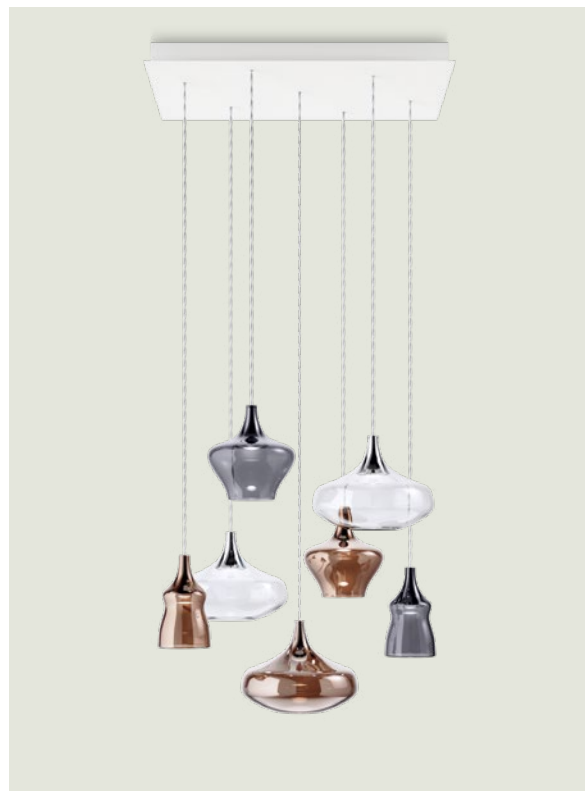

Nostalgia, 7 Lights Rectangular

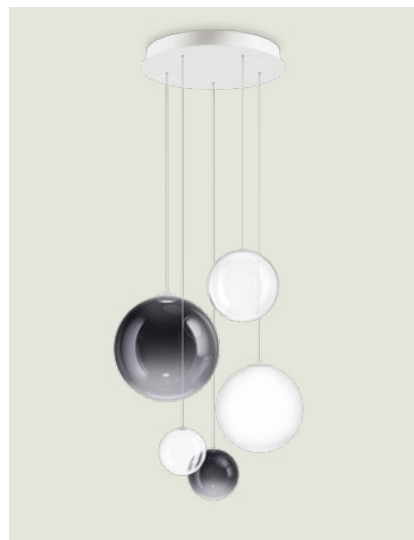

Random Solo, 5 Lights Round



Random, Long Lights Track



Spider, 5-12 Lights Radial

The product configurator highlights the creative and practical potential of *Lodes' canopies*. *Canopies* are available as either single or multiple systems. These highly functional lighting options can be installed in any part of a room regardless of power source and the design conceals electrical joints. *Lodes' canopies* are also a stand-out decorative element which gives individual light fixtures an original look and makes combinations of light fixtures truly unique. The variety of the range provides an array of possibilities to personalise any living space, whether residential or public.

The product configurator embodies the *Lodes* concept of “*standard bespoke*”, products which are universal yet particular to each client’s needs. This ensures that, having started from the standard elements, users of the tool can build a personal composition to suit their creative and technical requirements.

Il configuratore di prodotto evidenzia il potenziale creativo e pratico dei *rosoni Lodes*. I *rosoni* sono disponibili sia come elementi singoli che come sistemi multipli. Elementi di illuminazione altamente funzionali, i *rosoni* possono essere installati in qualsiasi parte della stanza indipendentemente dalla fonte di alimentazione e sono progettati in modo da nascondere i collegamenti elettrici. I *rosoni Lodes* sono anche un elemento decorativo che dona alle lampade singole un aspetto originale e rende le combinazioni davvero uniche. La varietà della gamma offre un ampio ventaglio di possibilità per personalizzare qualsiasi ambiente abitativo, sia esso residenziale o pubblico.

Il configuratore di prodotto dà forma al concetto *Lodes* di “*standard su misura – standard bespoke*”, prodotti universali ma particolari alle esigenze di ciascun cliente. Questo fa sì che, a partire da elementi standard e grazie al configuratore, gli utenti possano creare la composizione su misura che meglio soddisfa le loro esigenze creativi e tecnici.

Lodes product configurator

Discover more:



Create truly unique combinations of light fixtures with *Lodes' canopies*! Select a *lamp*, choose your *canopy* and create your *bespoke composition*.

Crea combinazioni di luci veramente uniche con i *rosoni Lodes*! Seleziona una *lampada*, scegli il tuo *rosone* e crea la tua *composizione personalizzata*.



New lamps 2023

01-08	Volum 14, 22, 29, 42 <i>design by</i> Snøhetta Wall lamp, Ceiling lamp, Table lamp	162
09	Tidal <i>design by</i> Needs Studio Ceiling lamp	328
10, 11	Hover <i>design by</i> YOY Table lamp, Floor lamp	274
12, 13	Elara medium Elara large <i>design by</i> Nika Zupanc Suspension lamp	022

Cluster suspension lamps

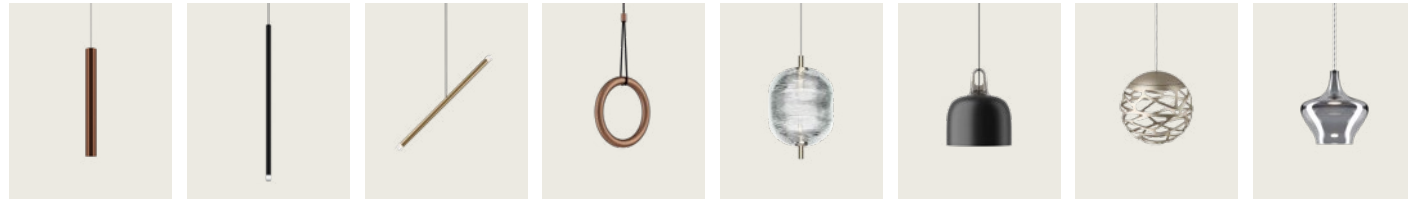

A-Tube Pag. 084 A-Tube Nano Pag. 056 A-Tube Nano Duo Pag. 074 IVY I Pag. 038 Jefferson Pag. 228 JIM Pag. 150 Kelly Cluster Pag. 124 Nostalgia Pag. 238

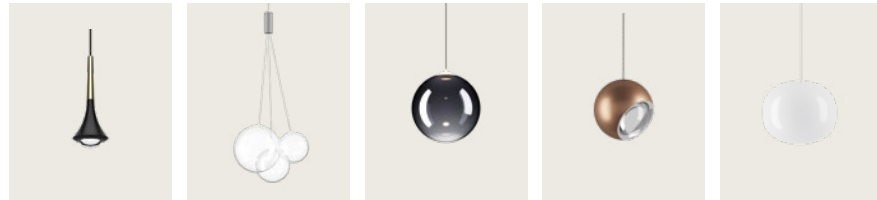

Rain Pag. 094 Random Pag. 188 Random Solo Pag. 204 Spider Pag. 108 Volum Pag. 162

Suspension lamps

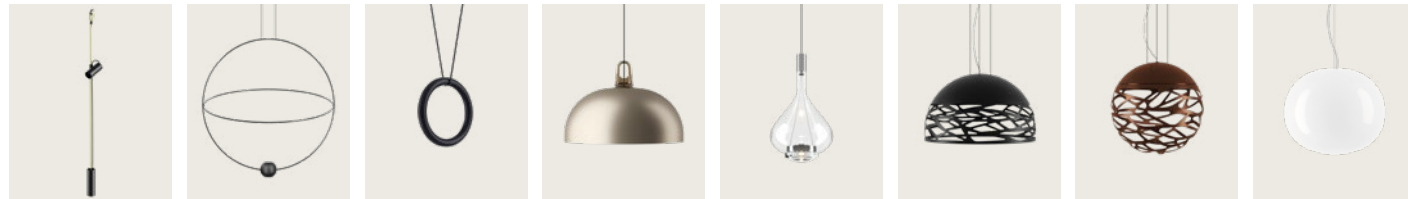

Cima Pag. 318 Elara Pag. 022 IVY V Pag. 038 JIM Pag. 150 Sky-Fall Pag. 252 Kelly dome Pag. 134 Kelly sphere Pag. 134 Volum Pag. 162

NEW LAMP

Wall lamps



Aile Pag. 354 Kelly Pag. 134 Laser Pag. 418 Make-Up Pag. 424 Nautilus Pag. 338 Nautilus Mini Pag. 338 Pin-Up Pag. 412 Puzzle Pag. 388

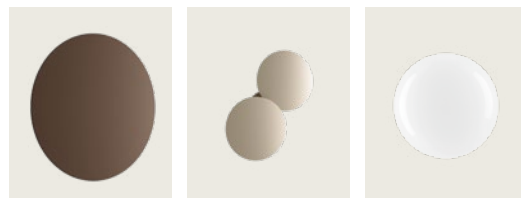

Puzzle Mega Pag. 362 Puzzle Round Pag. 378 Volum Pag. 162

NEW LAMP

Ceiling lamps



A-Tube Pag. 084 Bugia Pag. 404 Make-Up Pag. 424 Nautilus Pag. 338 Nautilus Spot Pag. 338 Pin-Up Pag. 412 Puzzle Pag. 388 Puzzle Mega Pag. 362



Puzzle Round Pag. 378 Spider Pag. 108 Tidal Pag. 328 Volum Pag. 162

NEW LAMP

NEW LAMP

Floor lamps



Cima Pag. 318 Cromia Pag. 304 Flar Pag. 264 Hover Pag. 274

NEW LAMP

Table lamps

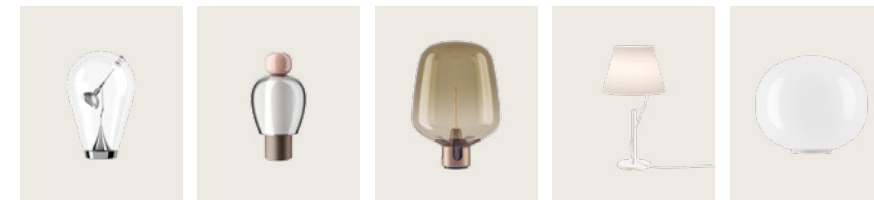

Blow Pag. 298 Easy Peasy Pag. 288 Flar Pag. 264 Hover Pag. 274 Volum Pag. 162

NEW LAMP

NEW LAMP

Outdoor lamp



Puzzle Outdoor Pag. 396

Elara

The name Elara connotes astronomy and Greek mythology, and its geometric design mimicks the trajectory of the planets within the universe. Inspired by astral motion, the lamp is characterised by two metal rings, one of which can be set at various angles to produce fluidity and movement, as well as a small sphere at the bottom of the lamp that contains the light source.

The central ring can be positioned to reach different heights and angles, allowing users to experiment with casting light and shadows. Elara features a dimmer controlled with the wall-mounted power switch, allowing users to modulate the intensity of the light to create their ideal lighting scheme.

Available in two sizes, medium (Ø 60 cm) and large (Ø 80 cm), Elara suits a range of environments, such as over a dining table in a residential setting, or as part of a larger installation in public spaces like a hotel lounge or restaurant.

Il nome Elara richiama l'astronomia e la mitologia greca, e il suo design geometrico imita la traiettoria dei pianeti nell'universo. Ispirata al movimento astrale, la lampada è caratterizzata da due anelli metallici, uno dei quali può essere posizionato a varie angolazioni per produrre fluidità e movimento, e da una piccola sfera all'estremità inferiore della lampada che contiene la sorgente luminosa. L'anello centrale può essere posizionato in modo da raggiungere diverse altezze e angolazioni, consentendo agli utenti di sperimentare la proiezione di luci e ombre. Inoltre, Elara è dimmerabile mediante dimmer comandato dall'interruttore a parete, che consente di modulare l'intensità della luce per creare il proprio schema di illuminazione ideale.

Disponibile in due dimensioni, medium (Ø 60 cm) e large (Ø 80 cm), Elara si adatta ad una vasta gamma di ambienti, come ad esempio sopra un tavolo da pranzo in un ambiente residenziale, o come parte di un'installazione più grande in spazi pubblici come la lounge di un hotel o un ristorante.

Suspension lamp

Elara medium and large,
FINISHES Black and Gold

Elara, *design by* Nika Zupanc, 2022



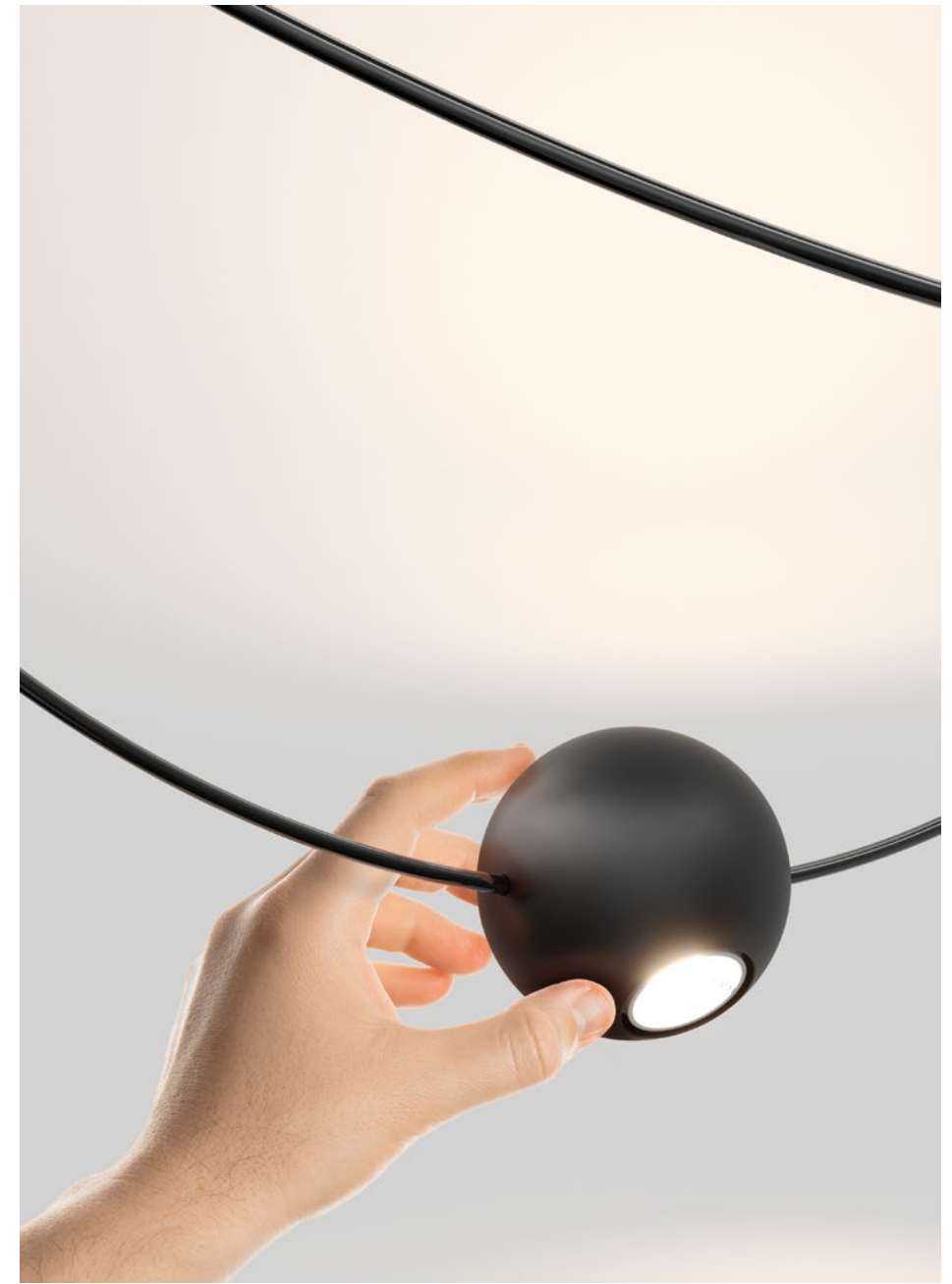

Elara, metal sphere, FINISH Extra Matte Black

Elara large, FINISH Black



Elara medium, FINISH Gold





028

Lodes



Elara, metal rings, FINISH Glossy Black

Elara large, FINISH Black

029

Elara

Suspension lamp



Elara is characterised by two metal rings, one of which can be set at various angles

Elara large, FINISH Gold





Elara large, FINISH Black

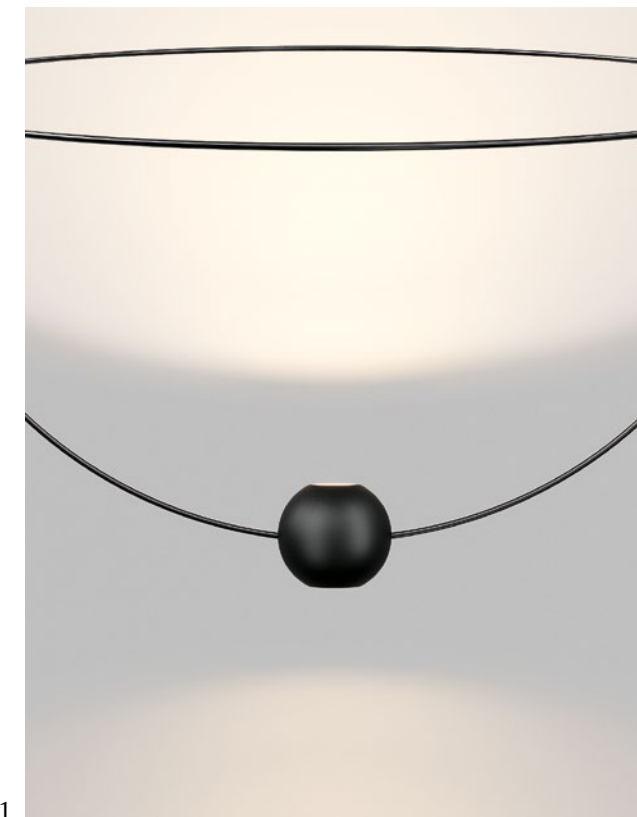

1



2

1–Metal sphere, side I (up)
side II (down), FINISH Extra Matte Black
2–Metal sphere, side I (down)
side II (up), FINISH Matte Gold



Elara medium and large,
FINISHES Black and Gold

034

Lodes

035

Elara

Suspension lamp

Le nom Elara évoque l'astronomie et la mythologie grecque, et son design géométrique la trajectoire des planètes dans l'univers. S'inspirant du mouvement astral, la lampe se caractérise par deux anneaux métalliques : un pouvant être positionné à différents angles, créant ainsi fluidité et mouvement, et par une petite sphère à l'extrémité inférieure de la lampe qui abrite la source lumineuse. L'anneau central peut être positionné pour atteindre différents angles et hauteurs, permettant aux utilisateurs d'expérimenter la projection de lumière et d'ombre. De plus, Elara est dimmable au moyen d'un gradateur contrôlé par l'interrupteur mural qui permet de moduler l'intensité de la lumière pour créer un éclairage idéal. Disponible en deux tailles, medium (Ø 60 cm) et large (Ø 80 cm), Elara s'adapte à une vaste gamme d'environnements, par exemple suspendue au-dessus d'une table dans une habitation, ou comme élément d'un agencement plus important tel qu'un hall d'hôtel ou un restaurant. ● FR

Der Name Elara erinnert an die Astronomie und die griechische Mythologie, und so ahmt das geometrische Design der Leuchte die Flugbahn der Planeten im Universum nach. Inspiriert von diesen astralen Bewegungen besteht die Leuchte aus zwei Metallringen, von denen einer in verschiedenen Winkeln positioniert werden kann, um eine fließende Bewegung zu erzeugen, sowie aus einer kleinen Kugel am unteren Ende der Leuchte, welche die Lichtquelle enthält. Der zentrale, horizontale Ring kann in verschiedenen Höhen und Winkeln positioniert werden, so dass die Benutzenden mit der Projektion von Licht und Schatten experimentieren können. Darüber hinaus ist Elara über einen an der Wand angebrachten Dimmer stufenlos regelbar, so dass die Lichtintensität je nach Bedarf angepasst werden kann, um individuellen Beleuchtungskonzepten gerecht zu werden. Erhältlich in zwei Größen, Medium (Ø 60 cm) und Large (Ø 80 cm), eignet sich Elara für eine Vielzahl von Umgebungen, wie z. B. über einem Esstisch im Wohnbereich oder als Teil einer größeren Installation in öffentlichen Räumen, wie einer Hotel-Lounge oder einem Restaurant. ● DE

Elara medium » Suspension lamp **NEW LAMP**



Elara large » Suspension lamp **NEW LAMP**

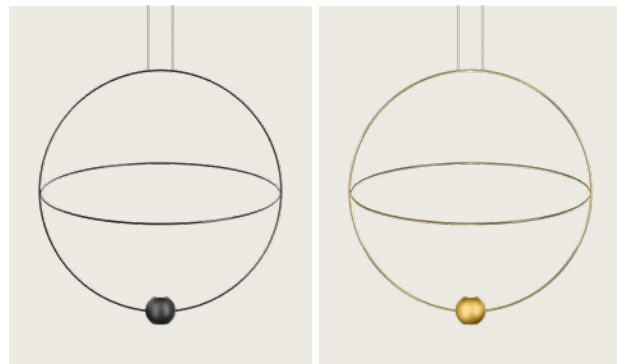

El nombre Elara evoca la astronomía y la mitología griega y su diseño geométrico imita la trayectoria de los planetas en el universo. Inspirada en el movimiento astral, la lámpara se caracteriza por dos anillos metálicos, uno de los cuales se puede colocar en distintos ángulos para crear fluidez y movimiento, y una pequeña esfera en el extremo inferior de la lámpara que contiene la fuente luminosa. El anillo central se puede colocar de forma que alcance distintas alturas y ángulos y permite a los usuarios experimentar la proyección de luces y sombras. Además Elara puede ajustarse con un regulador que controla el interruptor de pared y permite modular la intensidad de la luz para crear un esquema de iluminación ideal propio. Disponible en dos tamaños, medium (mediano) (Ø 60 cm) y large (grande) (Ø 80 cm), Elara se adapta a una amplia gama de ambientes, como por ejemplo encima de una mesa de comedor en un entorno residencial, o como parte de una instalación más grande en espacios públicos como el salón de un hotel o un restaurante. ● ES

Название Elara напоминает нам об астрономии и греческой мифологии, ее геометрический дизайн имитирует траектории движения планет во вселенной. Лампа, вдохновленная движением звезд, имеет два металлических кольца, одно из которых может устанавливаться под разными углами, создавая текучесть и мобильность, и небольшую сферу на нижней стороне лампы, содержащей внутри источник освещения. Центральное кольцо можно располагать на различной высоте и под разными углами, что позволяет пользователям экспериментировать с проекцией света и тени. Дополнительно к этому, Elara может регулироваться с помощью диммера, управляемого настенным выключателем, позволяющего регулировать интенсивность света и создавать собственную идеальную схему освещения. Elara выпускается в двух размерах, средний (Ø 60 см) и большой (Ø 80 см), и адаптируется к самым разнообразным помещениям, она может быть подвешена над

обеденным столом в жилом помещении или может стать частью более крупной инсталляции в общественных пространствах, таких как холл отеля или ресторан. ● RU

Elara一名呼应天文学和希腊神话,同时它的几何设计还仿照宇宙中的行星运行轨迹。受星体运动的启发,两只金属圆环是这款灯的特色所在,其中一只能够以不同角度定位,从而产生流动性和运动性,并使灯体下端形成一个容纳光源的小球体。中心圆环通过定位可达到不同高度和角度,允许用户尝试光与影的投射。此外,Elara可通过由壁式开关控制的调光器进行调光,使您能够在调整光线强度后营造理想的照明解决方案。Elara提供medium中号(Ø 60厘米)和large大号(Ø 80厘米)两种尺寸,适用于各种环境,例如居家环境中的餐桌上方或是在酒店休息室和餐厅等公共空间中作为大型装置的组成部分。● ZH

Visit website:



Elara, design by Nika Zupanc, 2022

Suspension lamp

Elara medium NEW

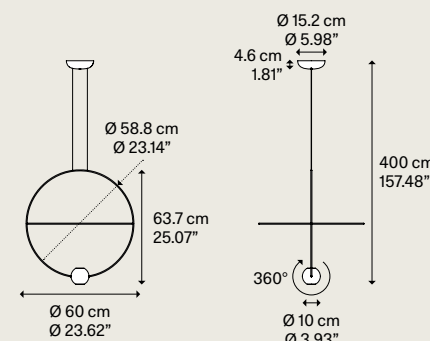

Light source Sorgente luminosa

LED
» 2700 K
» 27 W
Side I 2100 lm
Side II 800 lm
» 1000 mA
» CRI 90
» MacAdam 3-Step

or

LED
» 3000 K
» 27 W
Side I 2260 lm
Side II 845 lm
» 1000 mA
» CRI 90
» MacAdam 3-Step

LED and driver included
LED e driver inclusi

Metal structure Montatura in metallo

● Glossy Black
Nero Lucido

● Glossy Gold
Oro Lucido

● Glossy Black
Nero Lucido

● Glossy Gold
Oro Lucido

Metal sphere Sfera in metallo

● Extra Matte Black
Nero Extra Opaco

● Matte Gold
Oro Opaco

● Extra Matte Black
Nero Extra Opaco

● Matte Gold
Oro Opaco

Code Codice

20621 2227

20621 5027

20621 2230

20621 5030

Net weight/Peso netto: 1.9 kg

Pack/Coll: 1

Energy class/Classe energetica: 2700 K » D+E - 3000 K » D+F



IP20

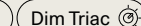
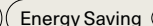

Elara large NEW

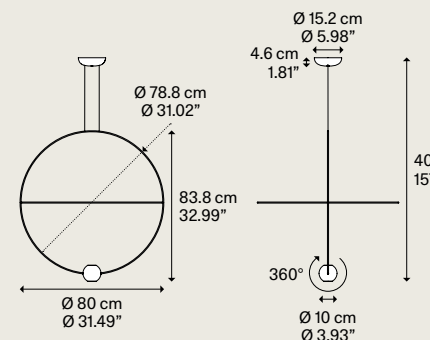

Light source Sorgente luminosa

LED
» 2700 K
» 27 W
Side I 2100 lm
Side II 800 lm
» 1000 mA
» CRI 90
» MacAdam 3-Step

or

LED
» 3000 K
» 27 W
Side I 2260 lm
Side II 845 lm
» 1000 mA
» CRI 90
» MacAdam 3-Step

LED and driver included
LED e driver inclusi

Metal structure Montatura in metallo

● Glossy Black
Nero Lucido

● Glossy Gold
Oro Lucido

● Glossy Black
Nero Lucido

● Glossy Gold
Oro Lucido

Metal sphere Sfera in metallo

● Extra Matte Black
Nero Extra Opaco

● Matte Gold
Oro Opaco

● Extra Matte Black
Nero Extra Opaco

● Matte Gold
Oro Opaco

Code Codice

20622 2227

20622 5027

20622 2230

20622 5030

Net weight/Peso netto: 2 kg

Pack/Coll: 1

Energy class/Classe energetica: 2700 K » D+E - 3000 K » D+F



IP20

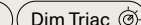
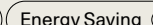

Adjustable light Luce orientabile

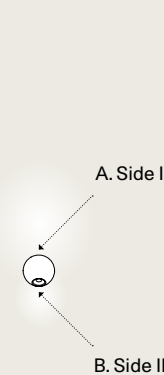

Adjustable ring Anello orientabile

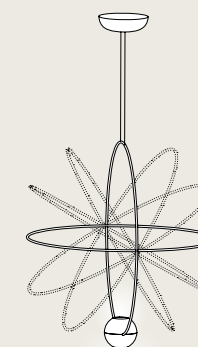

Ecodesign regulation ► pag. 444-445
Regolamento di Ecodesign ► pag. 444-445

IVY

IVY is a minimal, geometric lighting piece composed of a die-cast zinc alloy ring hanging on a black cable, which gives power to a made to measure LED module. The product sheds an even, rounded light beam through its thin and curved methacrylate diffuser. Designed with single and double cables, IVY responds to the need for flexibility, an increasingly contemporary theme in architectural practice and restoration, allowing the luminaire to be released from its ceiling derivation. Imagining the repetition and clustering of several lamps suggested the name IVY, while the ring reminds of a precious pendant on a necklace.

IVY è una lampada dalle linee minimaliste e geometriche costituita da un anello in lega di zinco pressofuso sospeso ad un cavo nero che aziona un modulo a LED realizzato su misura. Il prodotto emette un fascio di luce uniforme e omogeneo attraverso il sottile diffusore curvo in metacrilato. Dotata di cavi singoli e doppi, IVY risponde alla crescente esigenza di flessibilità nell'attuale contesto delle attività architettoniche e di ristrutturazione, consentendo di riposizionare la lampada rispetto alla fonte di alimentazione a soffitto. L'idea della ripetizione e del raggruppamento di più lampade ha ispirato il nome IVY, dall'inglese "edera", mentre l'anello richiama il prezioso ciondolo di una collana.

IVY I, Cluster suspension lamp

IVY V, Suspension lamp, Central cluster suspension lamp

IVY I and V, FINISHES Matte
Champagne and Matte Terra

IVY, *design by* Vittorio Massimo, 2022



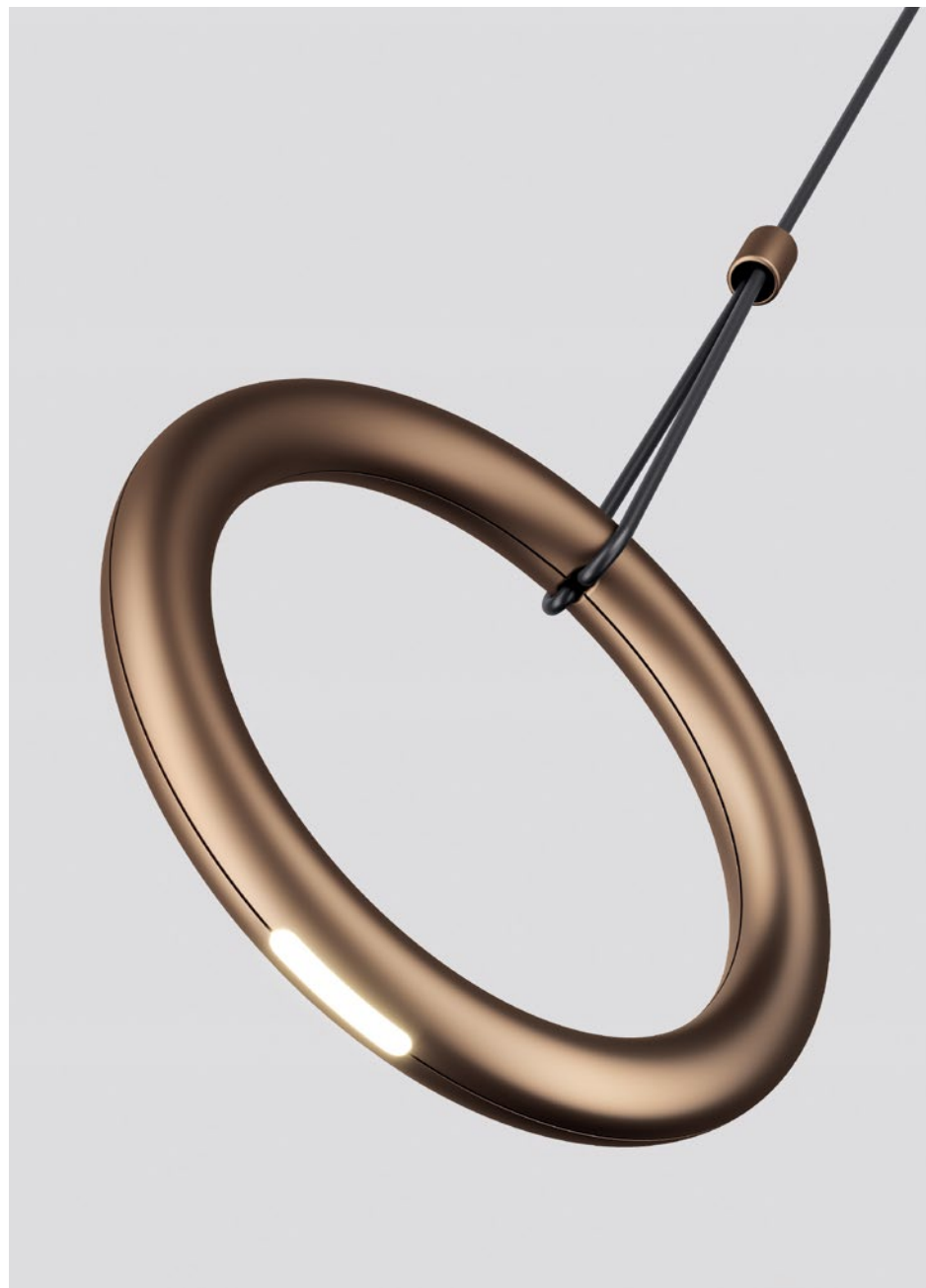

IVY I, FINISH Matte Terra, LED light source

IVY I, composition of 14 lights on a *rectangular canopy*, FINISHES Matte Black, Champagne and Terra





IVY I and V, FINISHES Matte Black, Champagne and Terra

IVY I, composition of 36 lights on a *round canopy*, FINISHES Matte Black and Champagne



IVY V, composition of 8 lights on a *central canopy*, FINISHES Matte Terra and Champagne
CENTRE: IVY I, *recessed micro canopies*, FINISH Matte Champagne

IVY I, 2 × composition of 3 lights on a *short track*, FINISHES Matte Terra and Champagne



1



2

1-IVY V, FINISH Matte Champagne
2-IVY V, FINISH Matte Terra

IVY I and V, *single mini canopies*,
FINISH Matte Terra



047

IVY

Cluster suspension lamp, Suspension lamp



IVY V, composition of 10 lights on a *central canopy*, FINISHES Matte Champagne and Black



IVY V, composition of 6 lights on a *central canopy*, FINISH Matte Black

IVY V, Examples of composition

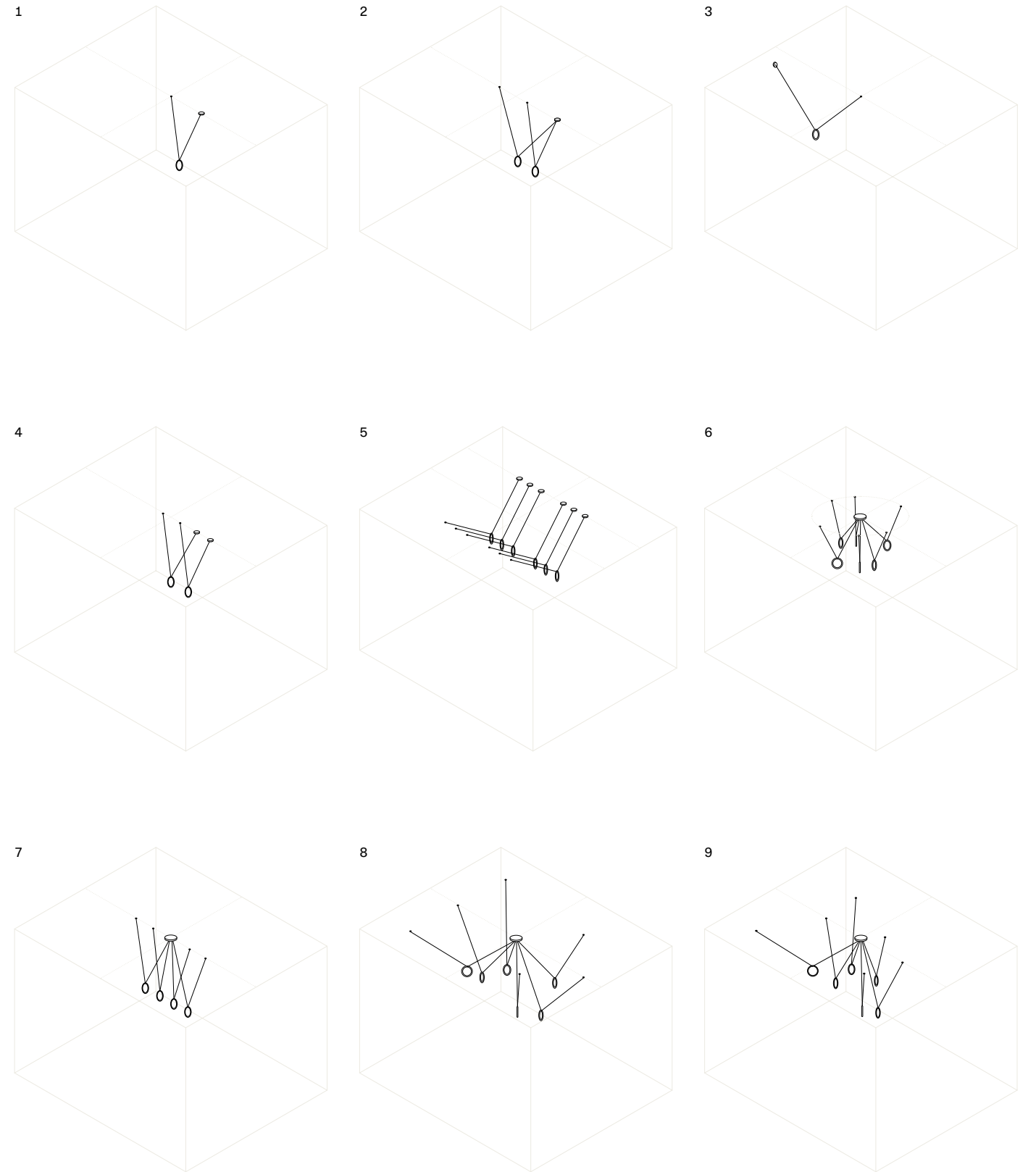

IVY est un élément d'éclairage minimaliste et géométrique fait d'un anneau en alliage de zinc moulé sous pression, suspendu à un câble noir qui alimente un module LED sur mesure. Le produit diffuse un faisceau lumineux uniforme et arrondi grâce à son diffuseur en méthacrylate fin et incurvé. Conçu avec des câbles simples et doubles, IVY répond au besoin de flexibilité, un thème de plus en plus contemporain dans la pratique architecturale et la restauration, permettant au luminaire d'être libéré de sa dérivation de plafond. Le nom IVY, anglais pour « lierre », s'inspire du regroupement de plusieurs lampes en cluster, tandis que l'anneau rappelle le précieux pendentif d'un collier. ● FR

IVY ist ein minimalistisches, geometrisches Beleuchtungsobjekt, bestehend aus einem Ring aus druckgegossener Zinklegierung, aufgehängt an einem schwarzen Kabel, das ein maßgefertigtes LED-Modul mit Strom versorgt. Das Produkt wirft einen gleichmäßigen, runden Lichtstrahl durch seinen dünnen und gebogenen Methacrylat-Diffusor. Entworfen mit einzelnen und doppelten Kabeln ist IVY die Antwort auf das Bedürfnis nach Flexibilität, ein zunehmend aktuelles Thema in der architektonischen Praxis und Restoration, das es der Leuchte ermöglicht, sich von ihrer Deckenableitung zu lösen. Die Vorstellung von der Wiederholung und Cluster mit mehreren Leuchten inspirierten zu dem Namen IVY, englisch für „Efeu“, während der Ring an einen kostbaren Anhänger einer Halskette erinnert. ● DE

IVY es un elemento de iluminación minimalista y geométrico compuesto de un aro de aleación de cinc fundido que cuelga de un cable negro, el cual alimenta a un módulo LED hecho a medida. La lámpara proyecta un haz de luz redondeado y homogéneo a través de su fino y curvado difusor de metacrilato. Diseñada con cables individuales y dobles, IVY responde a la necesidad de flexibilidad, una temática cada vez más de actualidad en la arquitectura y la restauración, que permite liberar el punto de luz de su derivación en el techo. El nombre IVY, «hiedra» en inglés, sugiere la repetición y la agrupación de varias lámparas, mientras que su aro recuerda al colgante de un collar. ● ES

IVY – это минималистичный геометрический осветительный элемент, состоящий из литого под давлением кольца, выполненного из цинкового сплава, подвешенного на черном кабеле, подающем питание к индивидуально изготовленному светодиодному модулю. Лампа излучает ровный круглый световой луч, проходящий через тонкий и изогнутый диффузор из метакрилата. Спроектированная с использованием одинарных и двойных кабелей, лампа IVY отвечает потребности в универсальности, все более актуальной в современной архитектуре и реконструкциях, позволяя освободить светильник от связи с потолком. Образ повторяющихся и объединенных в кластер ламп подсказал название IVY, что в переводе с английского означает "плющ", само кольцо напоминает драгоценный кулон на колье. ● RU

IVY 是一款极简几何照明件,由一只悬挂于一根黑色线缆上的压铸锌合金圆环组成,线缆可为定制型LED模块供电。该产品通过其细薄而弯曲的甲基丙烯酸酯灯罩散发均匀的圆形光束。采用单线缆和双线缆设计,IVY回应了对灵活性的需求,这是建筑实践与装修中一个日趋现代的主题,可将灯具重新定位于一个与位于天花板的电源处有所不同的地方。IVY之名建立在对更多灯件的重复和组吊的想象中,而圆环则令人忆起项链上的精美吊坠。● ZH

Visit website:



IVY I, design by Vittorio Massimo, 2022

Cluster suspension lamp

IVY I

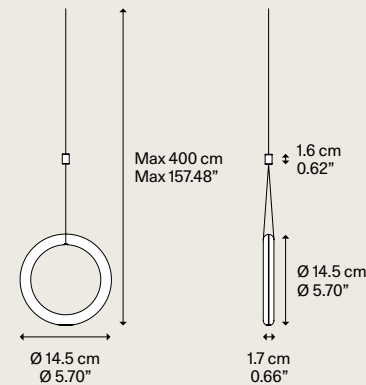

Light source Sorgente luminosa

LED
 ↘ 2700 K
 ↘ 3 W / 450 lm
 ↘ 350 mA
 ↘ CRI 90
 ↘ MacAdam 3-Step

LED
 ↘ 3000 K
 ↘ 3 W / 480 lm
 ↘ 350 mA
 ↘ CRI 90
 ↘ MacAdam 3-Step

LED and driver included
 LED e driver inclusi

Metal structure Montatura in metallo

● Matte Black – 9005
 Nero Opaco – 9005

● Extra Matte Champagne
 Champagne Extra Opaco

● Terra
 Terra

● Matte Black – 9005
 Nero Opaco – 9005

● Extra Matte Champagne
 Champagne Extra Opaco

● Terra
 Terra

Black cable
 Cavo Nero

Code Codice

17810 2020

17810 4520

17810 6720

17810 2035

17810 4535

17810 6735

Net weight / Peso netto: 0.5 kg

Pack / Colli: 1

Energy class / Classe energetica: 2700 K ▶ D – 3000 K ▶ C

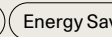
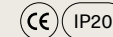

Suspension lamps must be installed on a canopy ▶ pag. 432–441
 Le lampade a sospensione devono essere installate su rosone ▶ pag. 432–441

Ecodesign regulation ▶ pag. 444–445
 Regolamento di Ecodesign ▶ pag. 444–445

IVY I ▶ Cluster suspension lamp

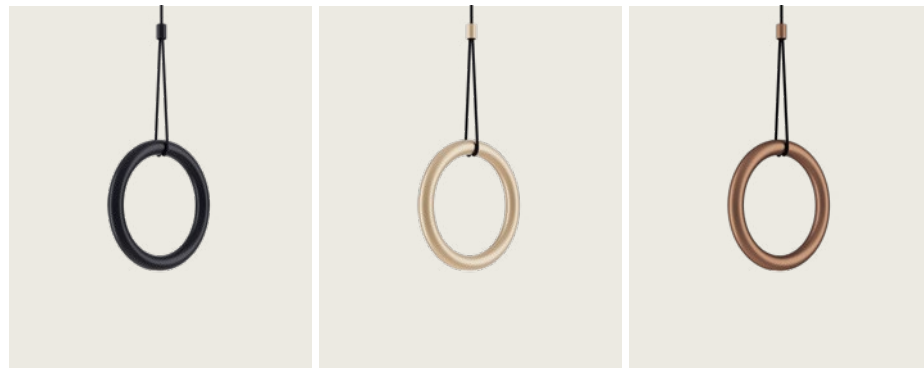

IVY V ▶ Central cluster suspension lamp, Suspension lamp

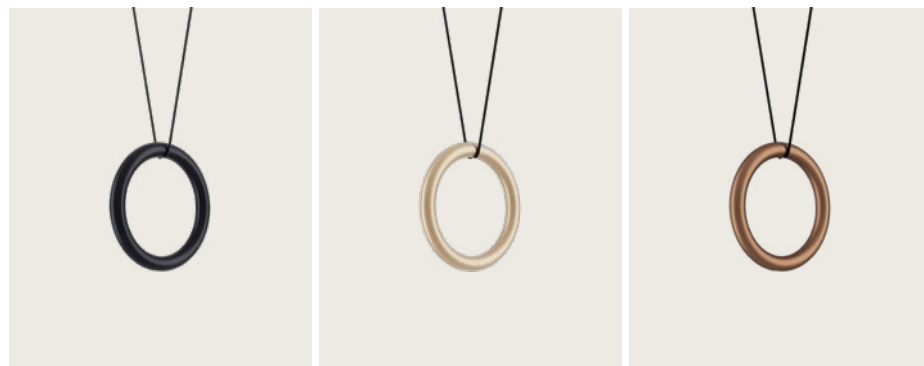

Example of composition

Short Lights Track

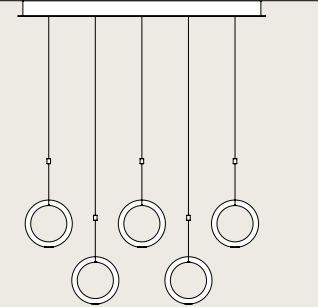
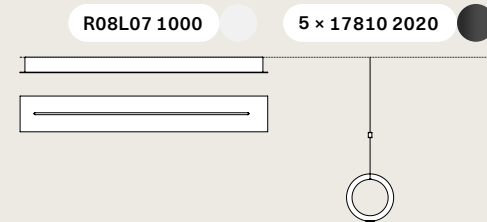

Example of composition

7 Lights Round

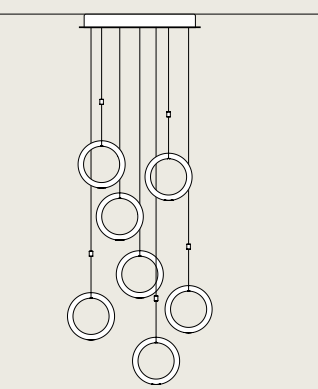
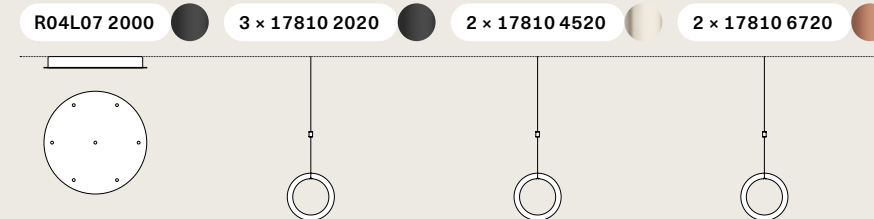

IVY V, design by Vittorio Massimo, 2022

Central cluster suspension lamp

IVY V

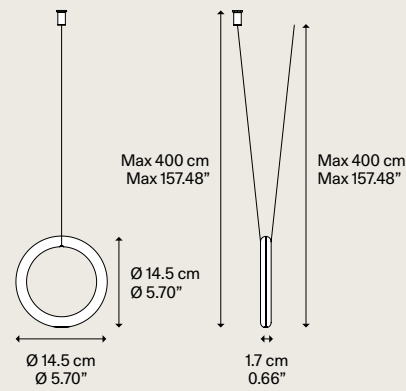

Light source Sorgente luminosa	Metal structure Montatura in metallo	Code Codice
LED ↘ 2700 K ↘ 3 W / 450 lm ↘ 350 mA ↘ CRI 90 ↘ MacAdam 3-Step	● Matte Black – 9005 Nero Opaco – 9005	17820 2020
or	● Extra Matte Champagne Champagne Extra Opaco	17820 4520
	● Terra Terra	17820 6720
LED ↘ 3000 K ↘ 3 W / 480 lm ↘ 350 mA ↘ CRI 90 ↘ MacAdam 3-Step	● Matte Black – 9005 Nero Opaco – 9005	17820 2035
	● Extra Matte Champagne Champagne Extra Opaco	17820 4535
● Terra Terra	17820 6735	
LED and driver included LED e driver inclusi	Black cable Cavo Nero	

Net weight/Peso netto: 0.58 kg

Pack/Colli: 1

Energy class/Classe energetica: 2700 K ▶ D – 3000 K ▶ C

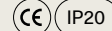

IP20

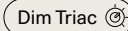
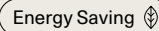

IVY V suspension lamps must only be installed on the single and central canopies below
Le lampade a sospensione IVY V devono essere installate solamente sui rosoni singoli e centrali di seguito

Ecodesign regulation ▶ pag. 444–445
Regolamento di Ecodesign ▶ pag. 444–445

Single canopy

Single Mini

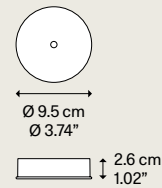

Description Descrizione	Methacrylate structure Struttura in metacrilato	System Sistema	Code Codice
Single ceiling bracket small size Rosone per lampada singola versione mini	● Matte Black – 9005 Nero Opaco – 9005	Single	R11L01 2000

Net weight/Peso netto: 0.13 kg

Pack/Colli: 1

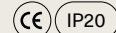

IP20

IVY V, design by Vittorio Massimo, 2022

Recessed canopy

Recessed Micro

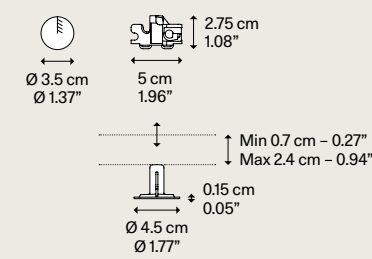

Net weight/Peso netto: 0.025 kg

Pack/Colli: 1

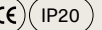

IP20

Description Descrizione	Methacrylate structure Struttura in metacrilato	System Sistema	Code Codice
Recessed bracket for single lamp max capacity 3.5 kg Rosone da incasso per lampada singola portata max 3.5 kg	● Matte Black Nero Opaco	Recessed	R01L01 2000

Central canopy

6 Lights Central

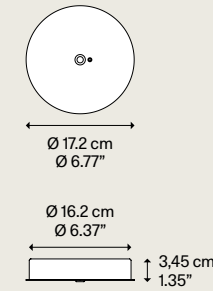

Net weight/Peso netto: 0.90 kg

Pack/Colli: 1

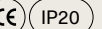

IP20

Description Descrizione	Metal structure Struttura in metallo	System Sistema	Code Codice
Central canopy max 6 suspension Rosone centrale max 6 sospensioni	● Matte Black – 9005 Nero Opaco – 9005	Cluster Central	R07L06 2000

12 Lights Central

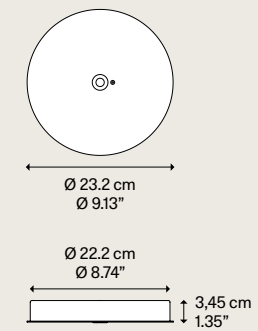

Net weight/Peso netto: 1.20 kg

Pack/Colli: 1

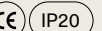

IP20

Description Descrizione	Methacrylate structure Struttura in metacrilato	System Sistema	Code Codice
Central canopy max 12 suspension Rosone centrale max 12 sospensioni	● Matte Black – 9005 Nero Opaco – 9005	Cluster Central	R07L12 2000

A–Tube Nano

A–Tube Nano is a suspension light which interprets light in its simplest form by creating a thin luminous line in the living spaces. At the lower end of the lightweight aluminium structure, a transparent methacrylate diffuser houses an LED module whose light creates a soft, welcoming atmosphere. The three sizes and seven statement finishes, including the new Terra, allow to create clusters of evocative lighting. Black cable version now available.

A–Tube Nano è una lampada a sospensione che interpreta la luce nella sua forma più essenziale disegnando una sottile linea luminosa nello spazio abitativo. All'estremità inferiore della leggera struttura in alluminio, un diffusore in metacrilato trasparente ospita un modulo LED la cui luce crea un'atmosfera morbida e avvolgente. Le tre dimensioni e le sette distinte finiture, con la nuova tonalità Terra, permettono di realizzare suggestive composizioni su cluster.

Cluster suspension lamp

A–Tube Nano small, medium and large,
composition of 5 lights on a *round canopy*,
FINISH Matte White

A–Tube Nano, *design by* Studio Italia Design, 2016

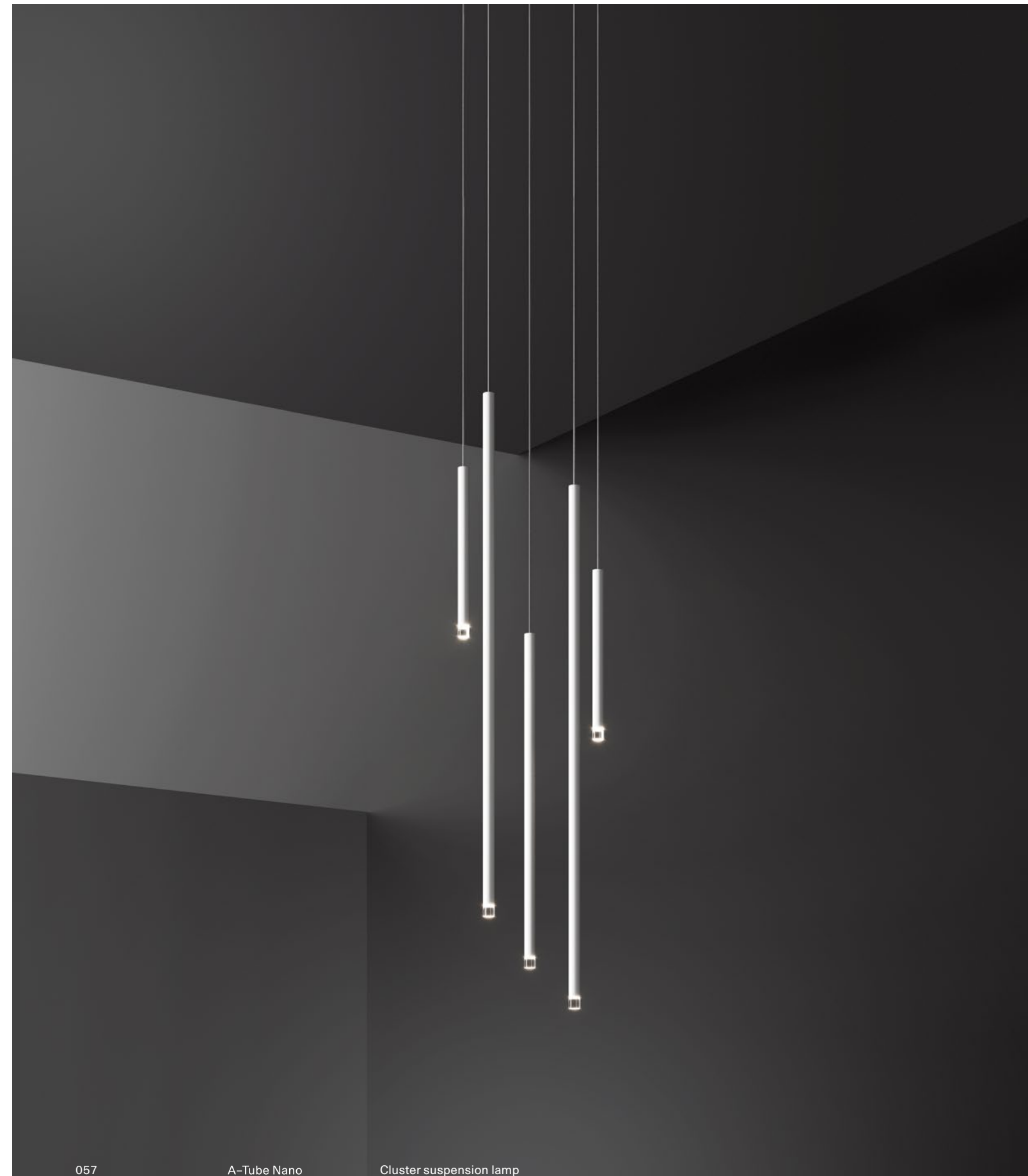



A-*Tube Nano* small, medium and large, special composition of 229 lights on *recessed micro canopies*

FINISHES Matte White, Chrome and Matte Champagne



A-Tube Nano large, *single mini canopies*,
FINISH Matte Champagne



A-*Tube Nano medium, composition of 5 lights on a round canopy, FINISH Matte Black*

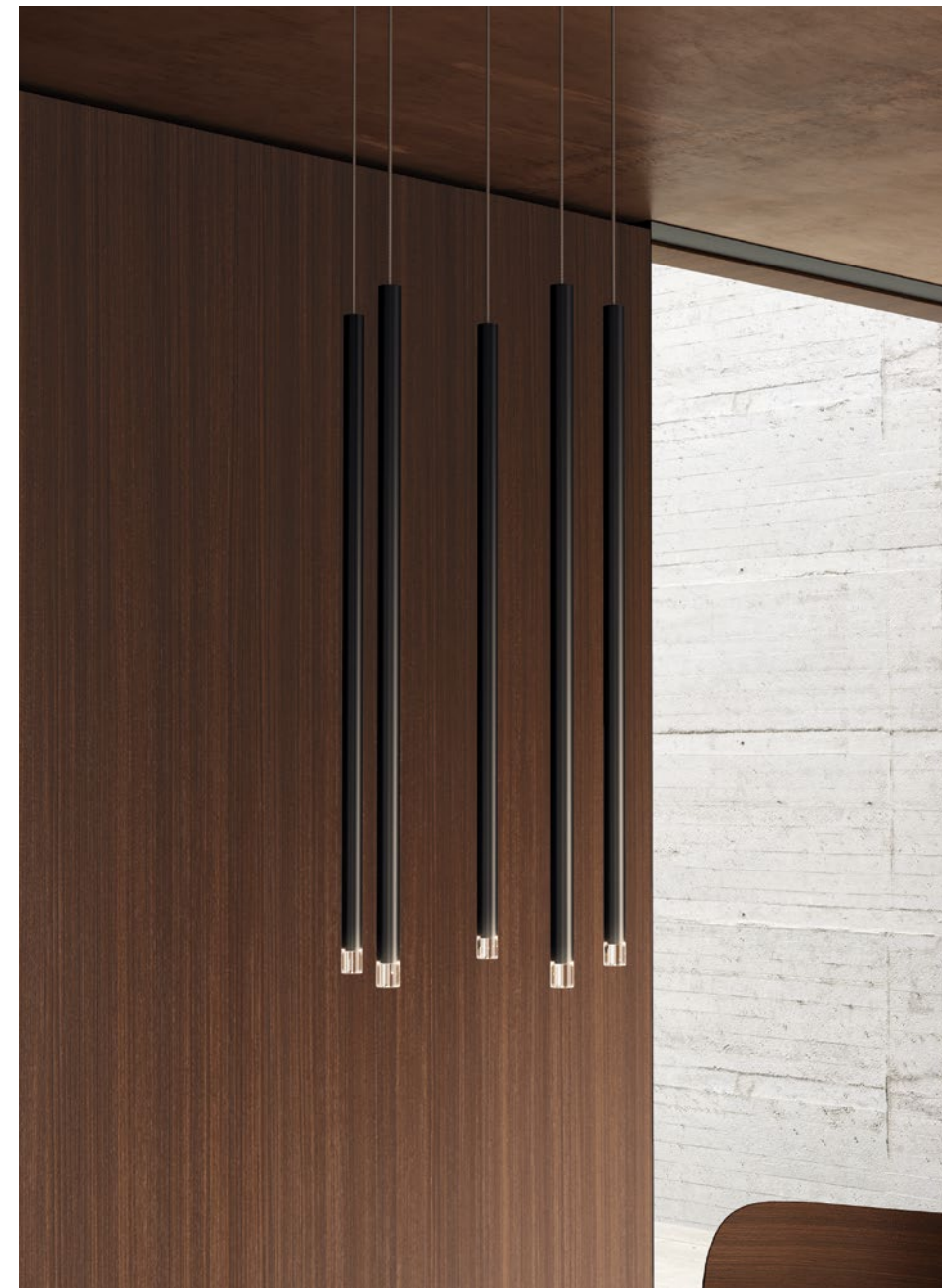

A-*Tube Nano medium, FINISH Matte Black*



A-*Tube Nano* small, medium and large, composition of 14 lights on a *rectangular canopy*

FINISHES Matte Black and Chrome, black cable version



A-*Tube Nano* small, medium and large, composition of 28 lights on a *rectangular canopy*, FINISHES Matte Black and Terra

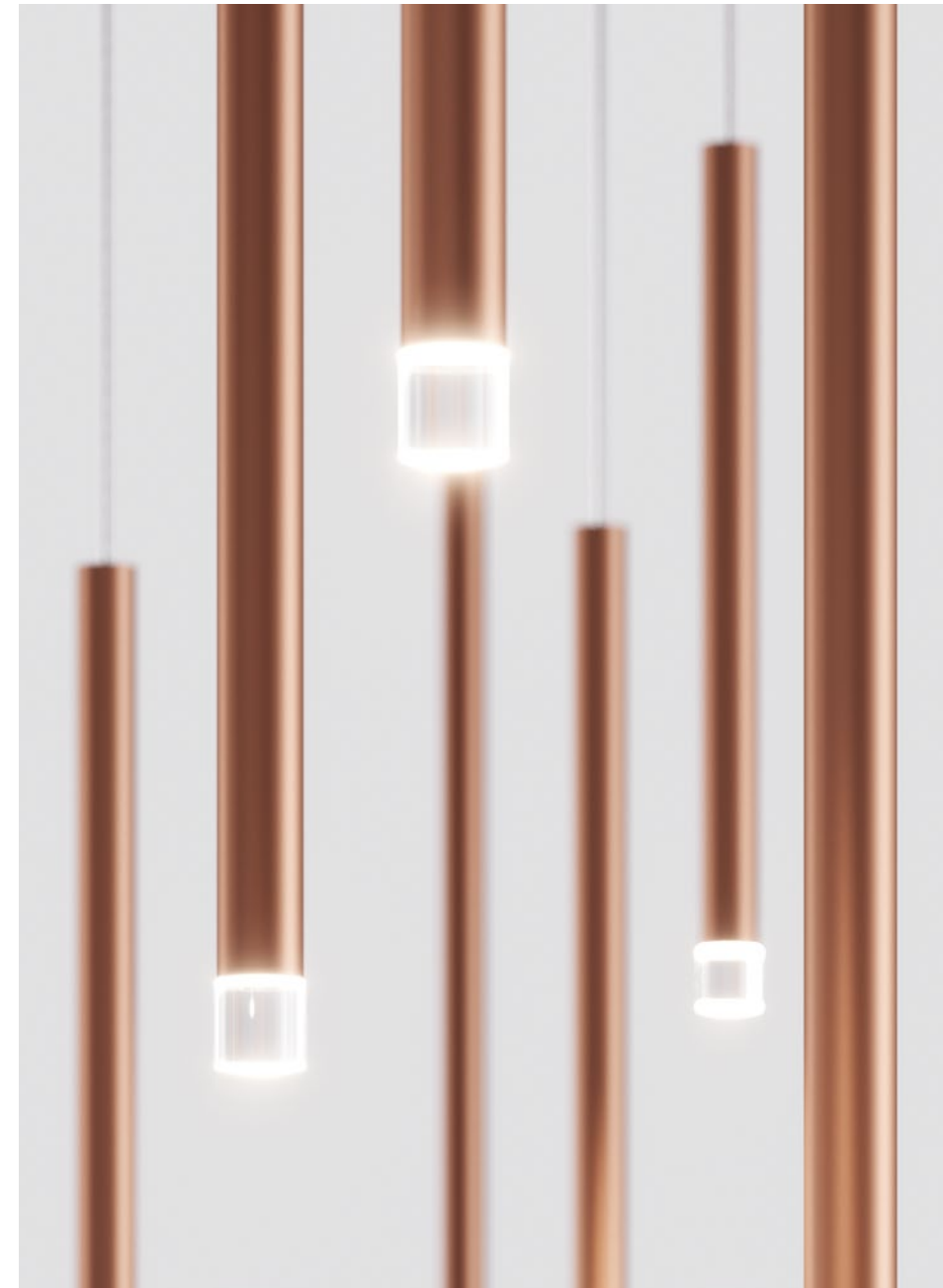

A-*Tube Nano*, FINISH Terra



A-Tube Nano est une suspension qui interprète la lumière dans sa forme la plus essentielle en dessinant une fine ligne lumineuse dans l'espace de vie. À l'extrémité inférieure de la structure en aluminium léger, un diffuseur en méthacrylate transparent abrite un module LED dont la lumière crée une atmosphère douce et enveloppante. Les trois dimensions et les sept finitions distinctes, dont la nouvelle Terra, permettent de créer des compositions suggestives en cluster. La version avec câble noir est maintenant disponible. ●FR

A-Tube Nano ist eine Hängeleuchte, die das Licht in seiner einfachsten Form interpretiert und für einen schmalen Lichtstreifen im Wohnraum sorgt. Am unteren Ende der leichten Armatur aus Aluminium enthält ein Diffusor aus Methacrylat ein LED-Modul, dessen Licht eine angenehme und umhüllende Atmosphäre entstehen lässt. Die drei Größen und sieben unterschiedlichen Ausführungen, darunter auch die neue Terra, ermöglichen die Umsetzung zauberhafter Kombinationen in Clustern. Schwarze Kabelversion jetzt verfügbar. ●DE

A-Tube Nano es una lámpara colgante que interpreta la luz en su forma más esencial distinguiendo una delgada línea luminosa en el espacio habitable. En el extremo inferior de la estructura ligera de aluminio, un difusor de metacrilato transparente acoge un módulo LED cuya luz crea una atmósfera suave y envolvente. Las tres dimensiones y los siete diferentes acabados, incluyendo el nuevo Terra, permiten realizar composiciones sugerativas en los grupos de lámparas colgantes. Ya está disponible la versión con cable negro. ●ES

A-Tube Nano – это подвесной светильник, который повторяет основную форму света, рисуя в жилом пространстве тонкую линию луча. В нижней части легкой алюминиевой конструкции в прозрачном диффузоре из метакрилата установлен светодиодный модуль, свет которого создает мягкую и обволакивающую атмосферу. Возможность выбора из трех размеров и шести различных отделок, включая новую тональность Terra, позволяет создавать потрясающие композиции на кластерах. Теперь доступна новая версия с черным кабелем. ●RU

A-Tube Nano是一款吊灯，以简约的形式诠释灯光，在居住空间中勾勒出纤细的光线。在轻盈的铝材结构下端，安装了透明的甲基丙烯酸甲酯灯罩，内置LED模块，灯光营造柔和温馨的气氛。三种尺寸和包含全新大地色调在内的六种颜色，可打造迷人的组合吊。黑色线缆版本现有供应。●ZH

Visit website:



A-Tube Nano small ▾ Cluster suspension lamp

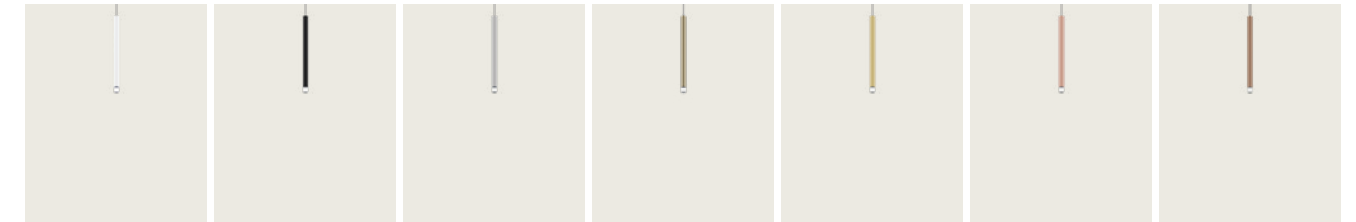

A-Tube Nano medium ▾ Cluster suspension lamp

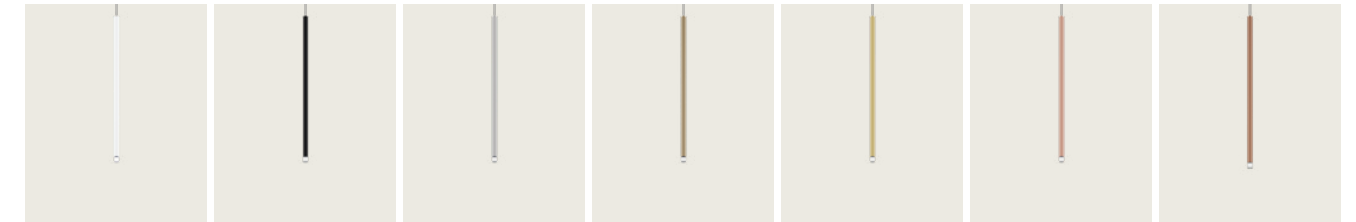

A-Tube Nano large ▾ Cluster suspension lamp

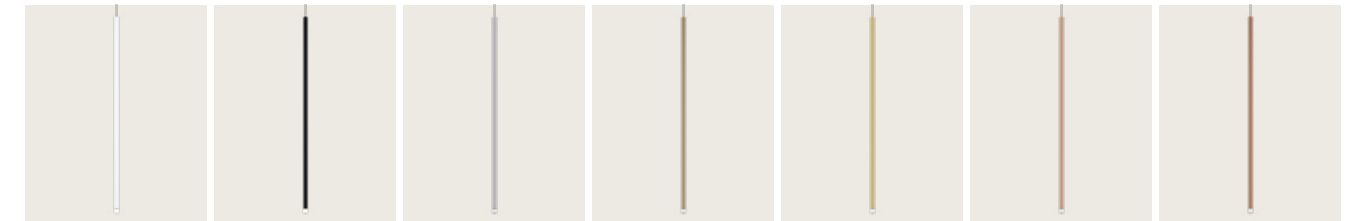

Transparent cable



Black cable



A-Tube Nano small, medium and large, recessed micro canopies, FINISHES Gold and Rose Gold

A-Tube Nano, design by Studio Italia Design, 2016

Cluster suspension lamp

A-Tube Nano small

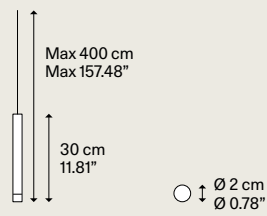

Light source Sorgente luminosa	Metal structure Montatura in metallo	Methacrylate diffuser Diffusore in metacrilato	Code Codice	
LED ↘ 2700 K ↘ 3 W/450 lm ↘ 350 mA ↘ CRI 90 ↘ MacAdam 3-Step LED and driver included LED e driver inclusi	Matte White - 9010 Bianco Opaco - 9010	Clear Trasparente	15822 1020	
	Matte Black - 9005 Nero Opaco - 9005		15822 2020	
	Chrome Cromo		15822 4020	
	Matte Champagne Champagne Opaco		15822 4520	
	Gold Oro		15822 5020	
	Rose Gold Oro Rosa		15822 5520	
	Terra Terra		Transparent cable Cavo Trasparente	15822 6720
	Matte White - 9010 Bianco Opaco - 9010		15826 1020	
	Matte Black - 9005 Nero Opaco - 9005		15826 2020	
	Chrome Cromo		15826 4020	
or	Matte Champagne Champagne Opaco	Clear Trasparente	15826 4520	
	Gold Oro	15826 5020		
	Rose Gold Oro Rosa	15826 5520		
	Terra Terra	Black cable Cavo Nero	15826 6720	
	Matte White - 9010 Bianco Opaco - 9010	15822 1035		
	Matte Black - 9005 Nero Opaco - 9005	15822 2035		
	Chrome Cromo	15822 4035		
	Matte Champagne Champagne Opaco	Clear Trasparente	15822 4535	
	Gold Oro	15822 5035		
	Rose Gold Oro Rosa	15822 5535		
LED ↘ 3000 K ↘ 3 W/480 lm ↘ 350 mA ↘ CRI 90 ↘ MacAdam 3-Step LED and driver included LED e driver inclusi	Terra Terra	Transparent cable Cavo Trasparente	15822 6735	
	Matte White - 9010 Bianco Opaco - 9010	15826 1035		
	Matte Black - 9005 Nero Opaco - 9005	15826 2035		
	Chrome Cromo	15826 4035		
	Matte Champagne Champagne Opaco	Clear Trasparente	15826 4535	
	Gold Oro	15826 5035		
	Rose Gold Oro Rosa	15826 5535		
	Terra Terra	Black cable Cavo Nero	15826 6735	

A-Tube Nano, design by Studio Italia Design, 2016

Cluster suspension lamp

A-Tube Nano medium

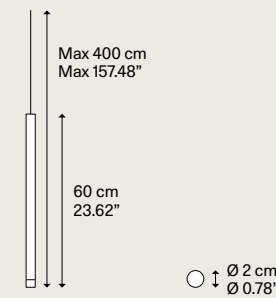

Light source Sorgente luminosa	Metal structure Montatura in metallo	Methacrylate diffuser Diffusore in metacrilato	Code Codice	
LED ↘ 2700 K ↘ 3 W/450 lm ↘ 350 mA ↘ CRI 90 ↘ MacAdam 3-Step LED and driver included LED e driver inclusi	Matte White - 9010 Bianco Opaco - 9010	Clear Trasparente	15823 1020	
	Matte Black - 9005 Nero Opaco - 9005		15823 2020	
	Chrome Cromo		15823 4020	
	Matte Champagne Champagne Opaco		15823 4520	
	Gold Oro		15823 5020	
	Rose Gold Oro Rosa		15823 5520	
	Terra Terra		Transparent cable Cavo Trasparente	15823 6720
	Matte White - 9010 Bianco Opaco - 9010		15827 1020	
	Matte Black - 9005 Nero Opaco - 9005		15827 2020	
	Chrome Cromo		15827 4020	
or	Matte Champagne Champagne Opaco	Clear Trasparente	15827 4520	
	Gold Oro	15827 5020		
	Rose Gold Oro Rosa	15827 5520		
	Terra Terra	Black cable Cavo Nero	15827 6720	
	Matte White - 9010 Bianco Opaco - 9010	15823 1035		
	Matte Black - 9005 Nero Opaco - 9005	15823 2035		
	Chrome Cromo	15823 4035		
	Matte Champagne Champagne Opaco	Clear Trasparente	15823 4535	
	Gold Oro	15823 5035		
	Rose Gold Oro Rosa	15823 5535		
LED ↘ 3000 K ↘ 3 W/480 lm ↘ 350 mA ↘ CRI 90 ↘ MacAdam 3-Step LED and driver included LED e driver inclusi	Terra Terra	Transparent cable Cavo Trasparente	15823 6735	
	Matte White - 9010 Bianco Opaco - 9010	15827 1035		
	Matte Black - 9005 Nero Opaco - 9005	15827 2035		
	Chrome Cromo	15827 4035		
	Matte Champagne Champagne Opaco	Clear Trasparente	15827 4535	
	Gold Oro	15827 5035		
	Rose Gold Oro Rosa	15827 5535		
	Terra Terra	Black cable Cavo Nero	15827 6735	

Net weight/Peso netto: 0.25 kg Pack/Colli: 2 Energy class/Classe energetica: D

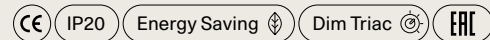

Net weight/Peso netto: 0.3 kg Pack/Colli: 2 Energy class/Classe energetica: D

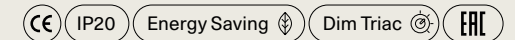

Cluster suspension lamp

A-Tube Nano large

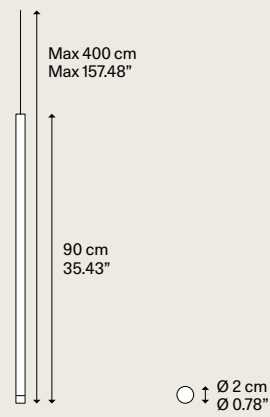

Light source Sorgente luminosa	Metal structure Montatura in metallo	Methacrylate diffuser Diffusore in metacrilato	Code Codice
LED ≈ 2700 K ≈ 3 W/450 lm ≈ 350 mA ≈ CRI 90 ≈ MacAdam 3-Step LED and driver included LED e driver inclusi	Matte White - 9010 Bianco Opaco - 9010	Clear Trasparente	15824 1020
	Matte Black - 9005 Nero Opaco - 9005		15824 2020
	Chrome Cromo		15824 4020
	Matte Champagne Champagne Opaco		15824 4520
	Gold Oro		15824 5020
	Rose Gold Oro Rosa	15824 5520	
	Terra Terra	Transparent cable Cavo Trasparente	15824 6720
	Matte White - 9010 Bianco Opaco - 9010	Transparent cable Cavo Trasparente	15828 1020
	Matte Black - 9005 Nero Opaco - 9005		15828 2020
	Chrome Cromo		15828 4020
Matte Champagne Champagne Opaco	15828 4520		
Gold Oro	15828 5020		
Rose Gold Oro Rosa	15828 5520		
Terra Terra	Black cable Cavo Nero		15828 6720
Matte White - 9010 Bianco Opaco - 9010	Black cable Cavo Nero		15824 1035
Matte Black - 9005 Nero Opaco - 9005			15824 2035
Chrome Cromo			15824 4035
Matte Champagne Champagne Opaco		15824 4535	
Gold Oro		15824 5035	
Rose Gold Oro Rosa		15824 5535	
Terra Terra		Transparent cable Cavo Trasparente	15824 6735
Matte White - 9010 Bianco Opaco - 9010		Transparent cable Cavo Trasparente	15828 1035
Matte Black - 9005 Nero Opaco - 9005			15828 2035
Chrome Cromo			15828 4035
Matte Champagne Champagne Opaco	15828 4535		
Gold Oro	15828 5035		
Rose Gold Oro Rosa	15828 5535		
Terra Terra	Black cable Cavo Nero		15828 6735

or

LED
≈ 3000 K
≈ 3 W/480 lm
≈ 350 mA
≈ CRI 90
≈ MacAdam 3-Step

LED and driver included
LED e driver inclusi

Net weight/Peso netto: 0.59 kg Pack/Coll: 2 Energy class/Classe energetica: D

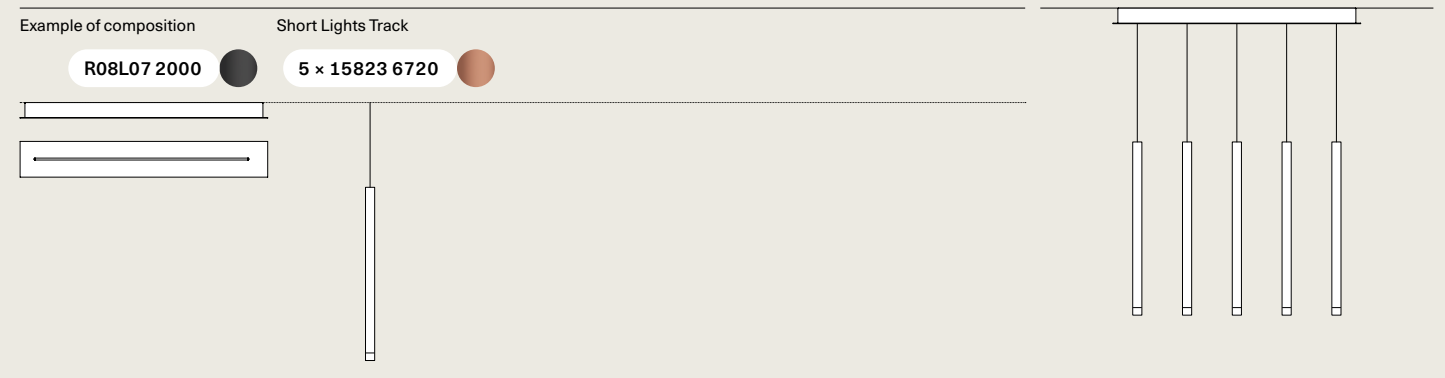
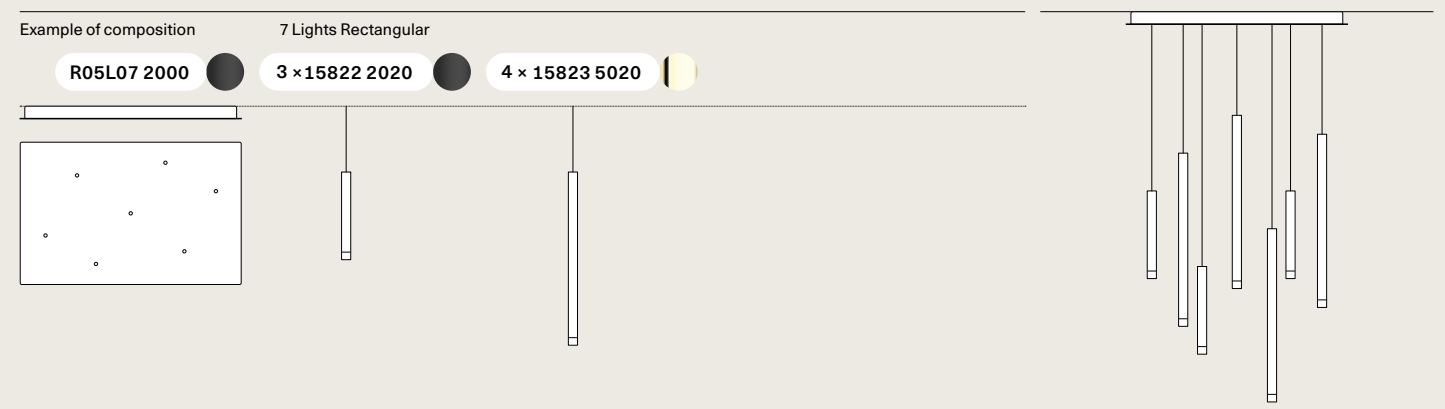
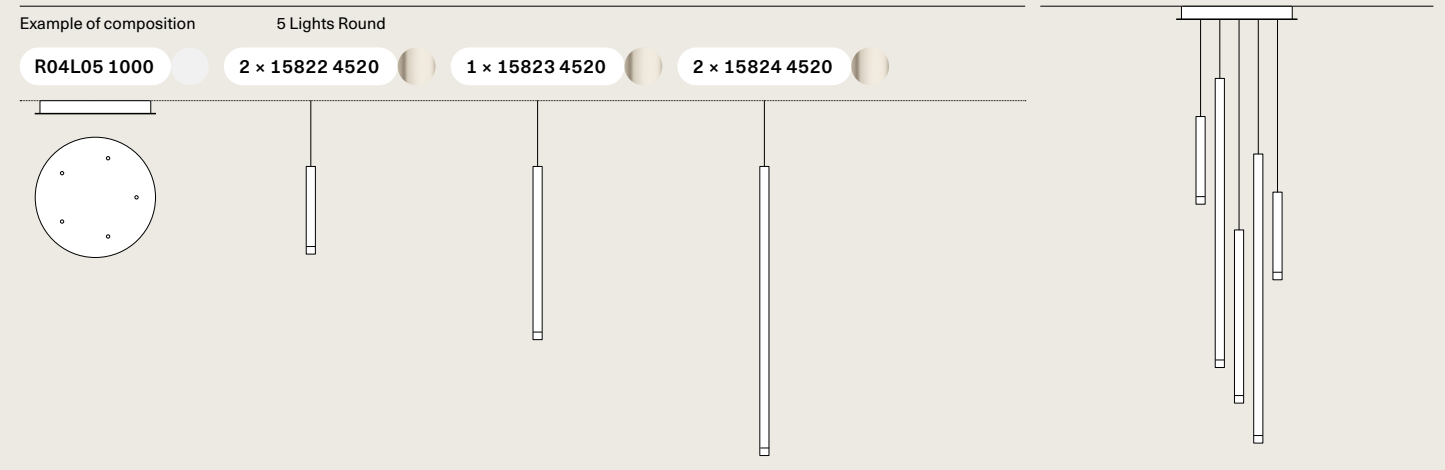
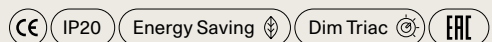

Suspension lamps must be installed on a canopy ▶ pag. 432-441
Le lampade a sospensione devono essere installate su rosone ▶ pag. 432-441

Ecodesign regulation ▶ pag. 444-445
Regolamento di Ecodesign ▶ pag. 444-445

A–Tube Nano Duo

Precious pins suspended from a thin cable, like magic lights floating in the space. A–Tube Nano Duo is an offshoot of A–Tube Nano with an LED light source on both ends of its thin metal body. A lightweight and linear lamp available in six finishes, which allows to create evocative and playful cluster compositions.

Preziose barrette sospese ad un cavo sottile, come magiche luci che galleggiano nello spazio. A–Tube Nano Duo è una variante di A–Tube Nano con sorgente luminosa a LED su entrambe le estremità del sottile corpo metallico. Una lampada leggera e lineare disponibile in sei finiture, con le quali si possono realizzare suggestive e giocose composizioni su cluster.

Cluster suspension lamp

A–Tube Nano Duo, composition of 7 lights on a *round canopy*, FINISHES Chrome and Matte Black

A–Tube Nano Duo, *design by* Studio Italia Design, 2017

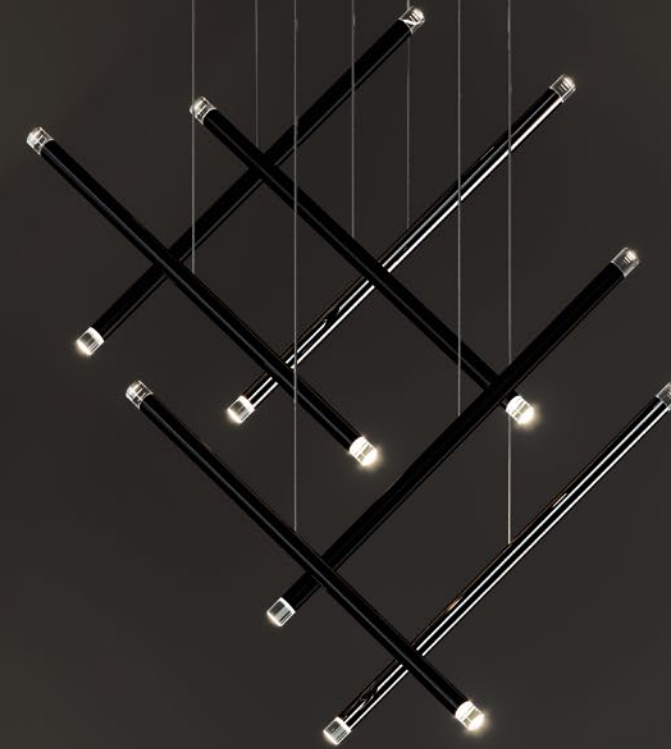

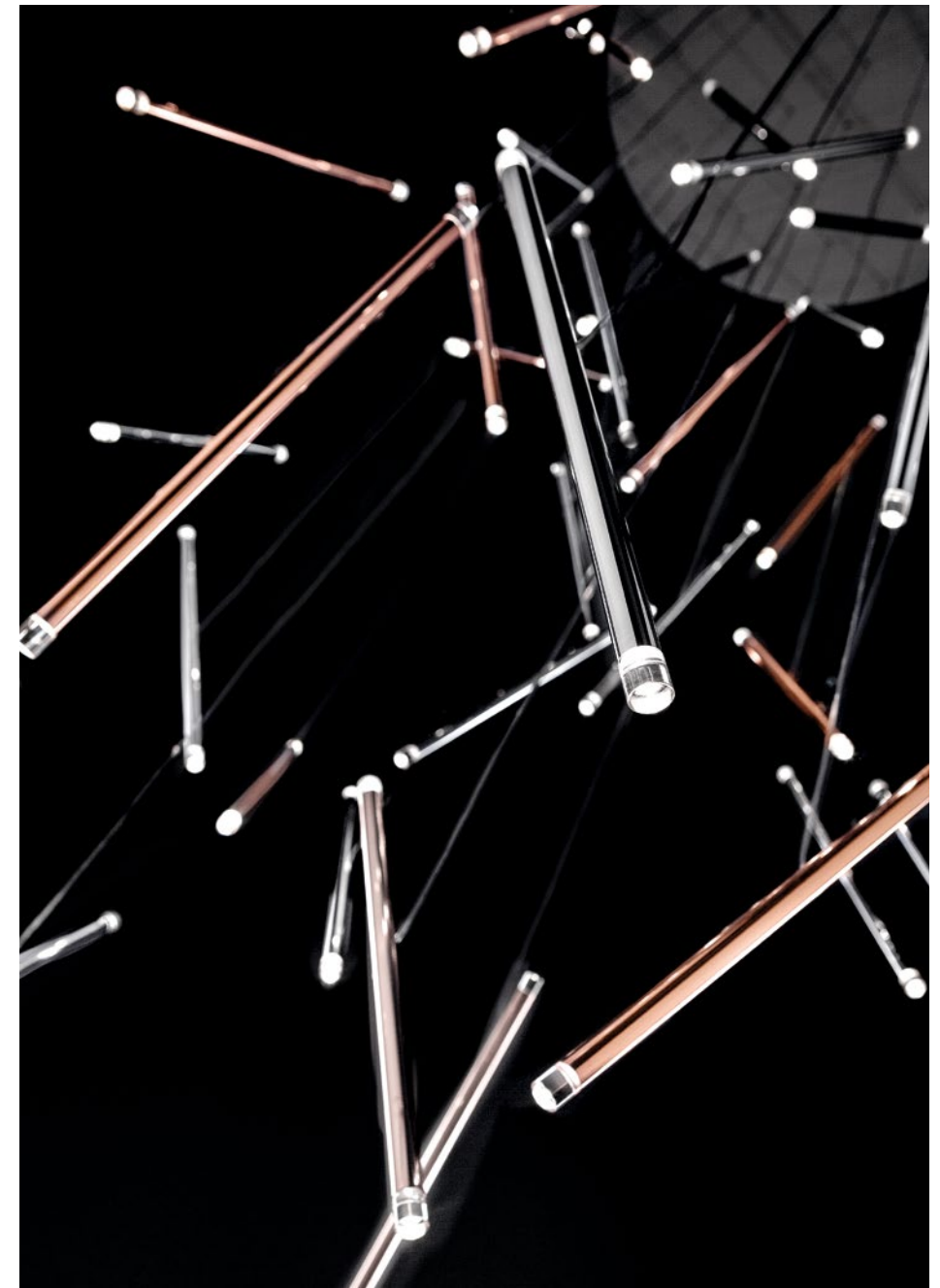

A-Tube Nano Duo, FINISHES Chrome and Rose Gold

A-Tube Nano Duo, composition of 36 lights on a *round canopy*, FINISH Matte Champagne



A-*Tube Nano Duo*, compositions of 24 lights
on a *round canopy*, FINISHES Matte White and Gold





A-Tube Nano Duo, special composition, FINISH Gold

De précieuses barres suspendues à un câble fin, comme des lumières magiques flottant dans l'espace. A-Tube Nano Duo est une variante de A-Tube Nano avec une source de lumière LED aux deux extrémités du fin corps métallique. Une lampe légère et linéaire disponible en six finitions, avec laquelle on peut créer des compositions multiples évocatrices et ludiques. ● FR

Wertvolle Balken, die an einem schmalen Kabel hängen, wie magisches Licht, das im Raum schwebt. A-Tube Nano Duo ist eine Variante von A-Tube Nano mit LED-Lichtquelle an beiden Enden des dünnen Metallkorpusses. Eine leichte und lineare Leuchte, in sechs Ausführungen verfügbar, mit denen wunderbare und verspielte Cluster-Kombinationen geschaffen werden können. ● DE

Preciosas barras suspendidas de un cable delgado, como luces mágicas flotando en el espacio. A-Tube Nano Duo es una variante de A-Tube Nano con fuente luminosa LED en ambos extremos del fino cuerpo de metal. Una lámpara ligera y lineal disponible en seis acabados, con la que se pueden crear sugestivas y divertidas composiciones en grupos de lámparas colgantes. ● ES

Изящные трубки, подвешенные на тонком кабеле, – словно волшебные огни, парящие в пространстве. Светильник A-Tube Nano Duo является вариантом A-Tube Nano с источником света LED на обоих концах тонкого металлического корпуса. Легкая прямолинейная лампа доступна в шести вариантах отделки, с использованием которых можно создавать очаровательные и живые кластерные композиции. ● RU

通过细细的电缆线将贵重的条形悬挂起来，就像漂浮在太空中的魔幻灯一样。A-Tube Nano Duo是A-Tube Nano的变型，在纤薄金属主体的两端均带有LED光源。这是一种轻巧的线性灯，有六种颜色，可以在组合吊上创建富有启发性和趣味性的构造。● ZH

Visit website:



A-Tube Nano Duo » Cluster suspension lamp



A-Tube Nano Duo, design by Studio Italia Design, 2017

Cluster suspension lamp

A-Tube Nano Duo

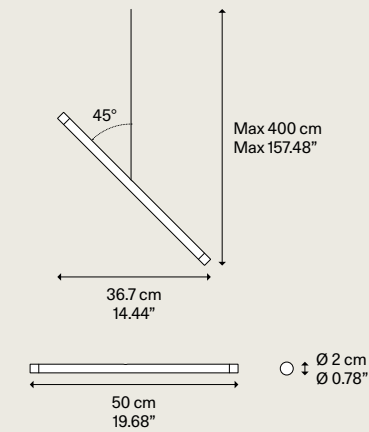

Light source
Sorgente luminosa

LED
 » 2700 K
 » 2 x 1 W/300 lm
 » 350 mA
 » CRI 90
 » MacAdam 3-Step

LED and driver included
LED e driver inclusi

Metal structure
Montatura in metallo

- Matte White – 9010
Bianco Opaco – 9010
- Matte Black – 9005
Nero Opaco – 9005
- Chrome
Cromo
- Matte Champagne
Champagne Opaco
- Gold
Oro
- Rose Gold
Oro Rosa

Methacrylate diffuser
Diffusore in metacrilato

- Clear
Trasparente

Code
Codice

- 15825 1020
- 15825 2020
- 15825 4020
- 15825 4520
- 15825 5020
- 15825 5520

Net weight/Peso netto: 0.21 kg Pack/Colli: 1 Energy class/Classe energetica: D

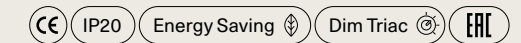

Suspension lamps must be installed on a canopy ► pag. 432-441
Le lampade a sospensione devono essere installate su rosone ► pag. 432-441

Ecodesign regulation ► pag. 444-445
Regolamento di Ecodesign ► pag. 444-445

Example of composition

5 Lights Round

R04L05 1000 1 x 15825 2020 2 x 15825 4020 2 x 15825 5020

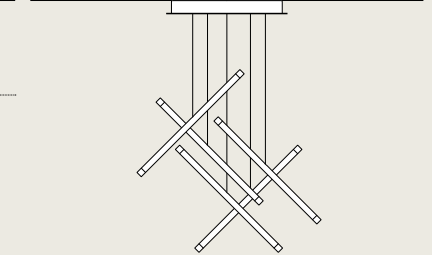
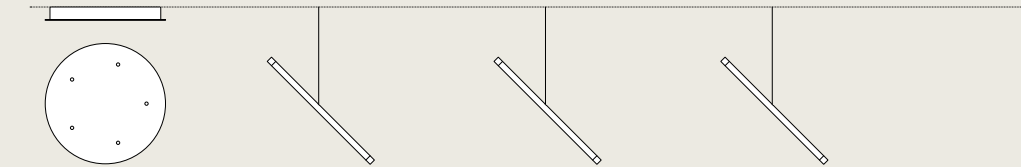

Example of composition

7 Lights Rectangular

R05L07 1000 2 x 15825 1020 4 x 15825 4020 1 x 15825 4520

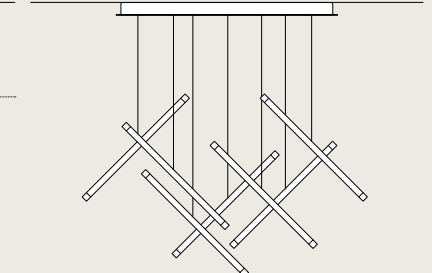
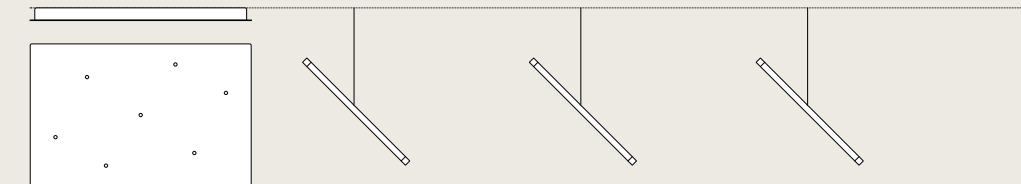

A-Tube

A simple form that delivers the light to wherever it's needed, enhancing the space. Tubular and slim, A-Tube is a versatile lamp available in four different sizes and three finishes. It can be fixed directly to the ceiling, suspended singularly, or used in cluster compositions to create impactful lighting effects.

Una forma semplice, che porta la luce dove si desidera valorizzando l'ambiente. Tubolare e sottile, A-Tube è una lampada versatile, disponibile in diverse dimensioni e in tre finiture. Può essere fissata direttamente al soffitto, sospesa singolarmente, oppure utilizzata in composizioni cluster d'effetto.

Cluster suspension lamp, Ceiling lamp

A-Tube medium, small and large,
composition of 3 lights on a *round canopy*,
FINISH Matte White

A-Tube, *design by* Studio Italia Design, 2013





A-Tube small and large, FINISH Matte Black



A-*Tube* medium, composition of 3 lights on a *long track*, FINISH *Coppery Bronze*

A-*Tube* mini, FINISH *Matte White*

Une forme simple, qui éclaire où vous le souhaitez tout en valorisant l'environnement. Tubulaire et fine, A-Tube est une lampe polyvalente, disponible en différentes dimensions et trois finitions. Elle peut être fixée directement au plafond, suspendue individuellement ou utilisée en compositions cluster. [FR](#)

Una forma simple, que lleva la luz donde se desea valorizando el ambiente. Tubular y sutil, la A-Tube es una lámpara versátil, disponible en diferentes tamaños y tres acabados. Puede fijarse directamente al techo, suspenderse individualmente o utilizarse en composiciones de grupos de lámparas colgantes de efecto. [ES](#)

外形简洁，可将光线照射到想要的地方。A-Tube呈管状且细长，是一种多功能灯，有不同尺寸和三种颜色可供选择。它可以直接吸顶安装，可以单独悬吊安装，也可以组合吊式安装。 [ZH](#)

Visit website:



Eine einfache Form, die das Licht in jenen Bereich des Raums bringt, der betont werden soll. Röhrenförmig und dünn, ist A-Tube eine vielseitige Lampe, die in verschiedenen Größen und drei Ausführungen verfügbar ist. Sie kann direkt an der Decke befestigt werden, einzeln hängend, oder zu wirkungsvollen Clustern kombiniert. [DE](#)

Простая незамысловатая форма, несущая свет туда, где это необходимо, и украшающая интерьер. Светильник A-Tube в форме тонкой изящной трубки является необыкновенно универсальным и доступен с разными размерами и с тремя типами отделки. Его можно крепить непосредственно к потолку, повесить отдельно или использовать в качестве эффектных кластерных композиций. [RU](#)

A-Tube mini ↘ Ceiling lamp

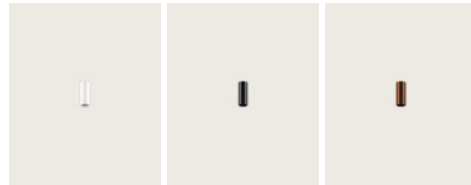

A-Tube small ↘ Ceiling lamp

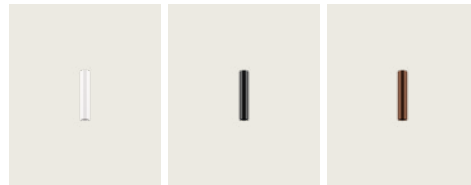

A-Tube small ↘ Cluster suspension lamp

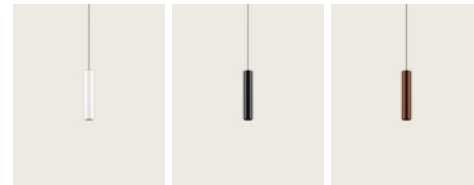

A-Tube medium ↘ Ceiling lamp

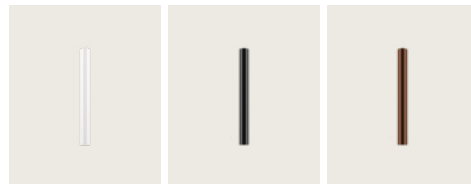

A-Tube medium ↘ Cluster suspension lamp

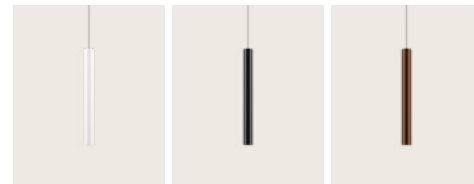

A-Tube large ↘ Ceiling lamp



A-Tube large ↘ Cluster suspension lamp



A-Tube, design by Studio Italia Design, 2013

Ceiling lamp

A-Tube mini



Net weight/Peso netto: 0.2 kg

Pack/Colli: 1

Light source
Sorgente luminosa

GU10 Par 16
↘ 1 × max 40W Eco II

or

GU10 Par 16 LED
↘ 1 × 10 W II

W/L max 9 cm
W/L max 3.54"

Bulb not included
Lampadina non inclusa

Metal structure
Montatura in metallo

Matte White - 9010
Bianco Opaco - 9010

Matte Black - 9005
Nero Opaco - 9005

Coppery Bronze
Bronzo Ramato

Code
Codice

09631 1000

09631 2000

09631 3500

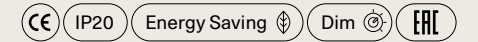

A-Tube small

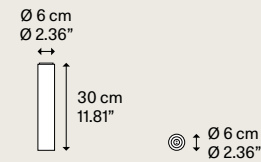

Net weight/Peso netto: 0.8 kg

Pack/Colli: 1

GU10 Par 16
↘ 1 × max 40W Eco II

or

GU10 Par 16 LED
↘ 1 × 10 W II

W/L max 9 cm
W/L max 3.54"

Bulb not included
Lampadina non inclusa

Matte White - 9010
Bianco Opaco - 9010

Matte Black - 9005
Nero Opaco - 9005

Coppery Bronze
Bronzo Ramato

09632 1000

09632 2000

09632 3500

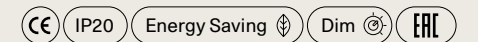

A-Tube medium

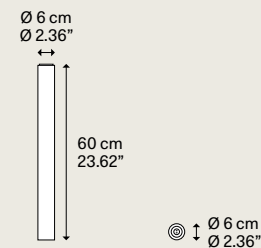

Net weight/Peso netto: 0.9 kg

Pack/Colli: 1

GU10 Par 16
↘ 1 × max 40W Eco II

or

GU10 Par 16 LED
↘ 1 × 10 W II

W/L max 9 cm
W/L max 3.54"

Bulb not included
Lampadina non inclusa

Matte White - 9010
Bianco Opaco - 9010

Matte Black - 9005
Nero Opaco - 9005

Coppery Bronze
Bronzo Ramato

09633 1000

09633 2000

09633 3500

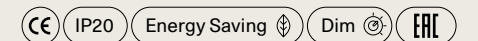

A-Tube large

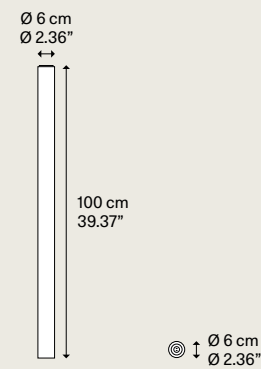

Net weight/Peso netto: 1.5 kg

Pack/Colli: 1

GU10 Par 16
↘ 1 × max 40W Eco II

or

GU10 Par 16 LED
↘ 1 × 10 W II

W/L max 9 cm
W/L max 3.54"

Bulb not included
Lampadina non inclusa

Matte White - 9010
Bianco Opaco - 9010

Matte Black - 9005
Nero Opaco - 9005

Coppery Bronze
Bronzo Ramato

09634 1000

09634 2000

09634 3500

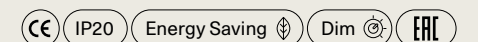

A-*Tube*, design by Studio Italia Design, 2013

Cluster suspension lamp

A-*Tube* small

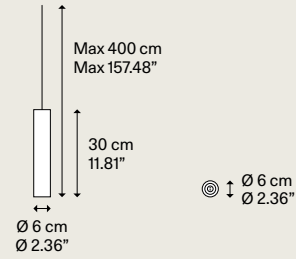

Net weight/Peso netto: 1.12 kg

Pack/Colli: 1

Light source
Sorgente luminosa

GU10 Par 16
↘ 1 × max 40W Eco III

or

GU10 Par 16 LED
↘ 1 × 10 W III

W/L max 8.5 cm
W/L max 3.34"

Bulb not included
Lampadina non inclusa

Metal structure
Montatura in metallo

Matte White - 9010
Bianco Opaco - 9010

Matte Black - 9005
Nero Opaco - 9005

Copperty Bronze
Bronzo Ramato

Code
Codice

09622 1000

09622 2000

09622 3500

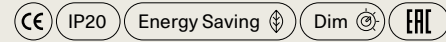

A-*Tube* medium

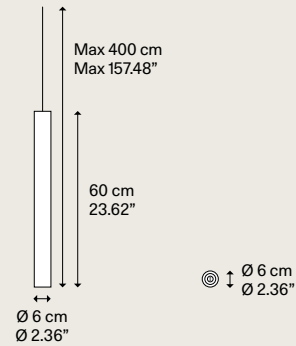

Net weight/Peso netto: 1.42 kg

Pack/Colli: 1

GU10 Par 16
↘ 1 × max 40W Eco III

or

GU10 Par 16 LED
↘ 1 × 10 W III

W/L max 8.5 cm
W/L max 3.34"

Bulb not included
Lampadina non inclusa

Matte White - 9010
Bianco Opaco - 9010

Matte Black - 9005
Nero Opaco - 9005

Copperty Bronze
Bronzo Ramato

09623 1000

09623 2000

09623 3500

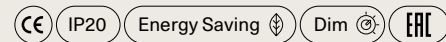

A-*Tube* large

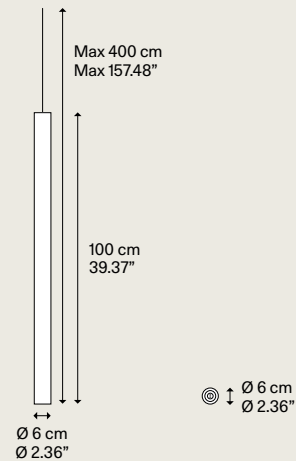

Net weight/Peso netto: 1.87 kg

Pack/Colli: 1

GU10 Par 16
↘ 1 × max 40W Eco III

or

GU10 Par 16 LED
↘ 1 × 10 W III

W/L max 8.5 cm
W/L max 3.34"

Bulb not included
Lampadina non inclusa

Matte White - 9010
Bianco Opaco - 9010

Matte Black - 9005
Nero Opaco - 9005

Copperty Bronze
Bronzo Ramato

09624 1000

09624 2000

09624 3500

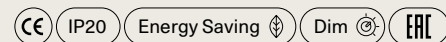

Suspension lamps must be installed on a canopy ▶ pag. 432-441
Le lampade a sospensione devono essere installate su rosone ▶ pag. 432-441

A-*Tube*, design by Studio Italia Design, 2013

Example of composition

5 Lights Round

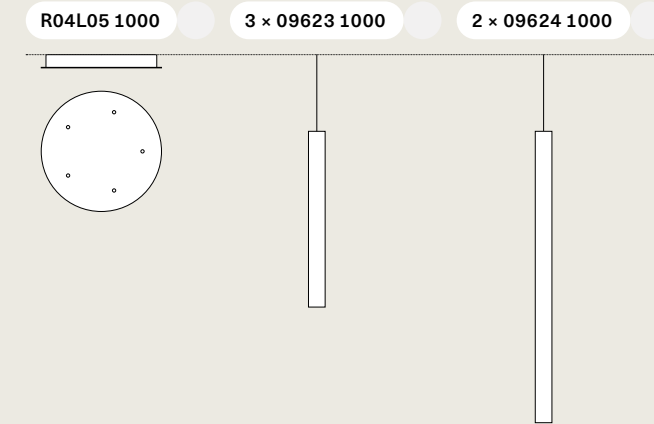

Example of composition

7 Lights Rectangular

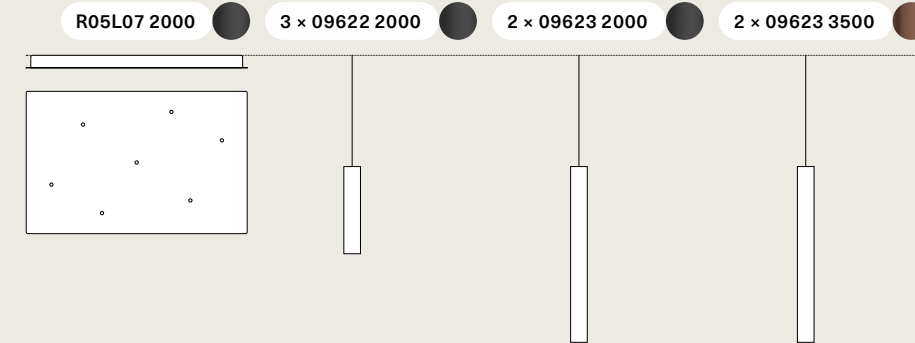

Example of composition

Short Lights Track

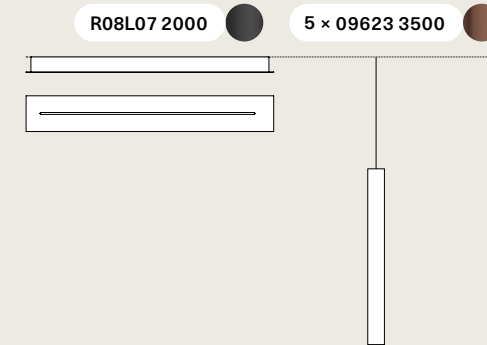

Rain

Rain falls from the ceiling like a drop of spring rain, with a linear movement that accentuates the curvaceous conical forms of its body. A metal suspension lamp with an LED light source – simple and effective, elegant and extremely bright, to be used either independently or as a scenic composition.

Rain scende dal soffitto come una goccia di pioggia primaverile, con un movimento lineare che accentua le sinuose forme coniche del suo corpo. Una sospensione in metallo con sorgente luminosa a LED – semplice ed efficace, elegante ed estremamente luminosa, da usare da sola o in composizioni scenografiche.

Cluster suspension lamp

Rain, FINISHES Matte Black + Matte Black and Matte Black + Coppery Bronze, black cable and black structure version

Rain, *design by* Andrea Tosetto, 2015





Rain, FINISHES Chrome + Brushed Chrome and Chrome + Rose Gold

Rain, composition of 24 lights
on a *round canopy*



Rain, special composition of 287 lights on recessed micro canopies, FINISH Matte Black + Gold, black cable and black structure version



Rain, FINISH Chrome + Brushed Chrome

Rain, composition of 3 lights on a *short track*,
FINISH Chrome + Coppery Bronze



Rain, composition of 5 lights on a *round canopy* and single lights on *recessed micro canopies*

FINISHES Matte Black + Matte Black and Matte Black + Brushed Chrome, black cable and black structure version



Rain, FINISH Chrome + Matte Black

Rain, une goutte de pluie printanière descend du plafond, avec un mouvement linéaire qui accentue les sinueuses formes coniques de son corps. Une suspension en métal avec source lumineuse LED – simple et efficace, élégante et très lumineuse, à utiliser seule ou en compositions scénographiques. ●FR

Rain kommt von der Decke herab wie ein Regentropfen im Frühling, mit einer linearen Bewegung, die die geschwungenen, konischen Formen des Korpus betont. Eine Aufhängung aus Metall mit LED-Lichtquelle, einfach und effizient, elegant und besonders stark leuchtend, einzeln oder in wirkungsvollen Kombinationen zu verwenden. ●DE

Rain cae como una gota de lluvia primaveral del techo, con un movimiento lineal que acentúa las sinuosas formas cónicas de su cuerpo. Colgante de metal con fuente luminosa LED, simple y efectiva, elegante y extremadamente brillante, para usarla sola o en composiciones escénicas. ●ES

Светильник Rain спускается с потолка подобно капле весеннего дождя, прямолинейность падения которой оттеняет изгибы конических форм его корпуса. Металлический подвесной светильник с источником света LED – простой и эффективный, элегантный и необыкновенно яркий, для использования отдельно или в композициях со сценическим эффектом. ●RU

Rain就如从天花板上滴下的一滴春雨，以线性运动加重了其主体的弯曲圆锥形的外形。具有LED光源的金属悬架简单有效，优雅且非常明亮，可单独使用或在场景中组合使用。●ZH

Visit website:



Rain ▸ Cluster suspension lamp



Transparent cable and chrome structure Black cable and black structure

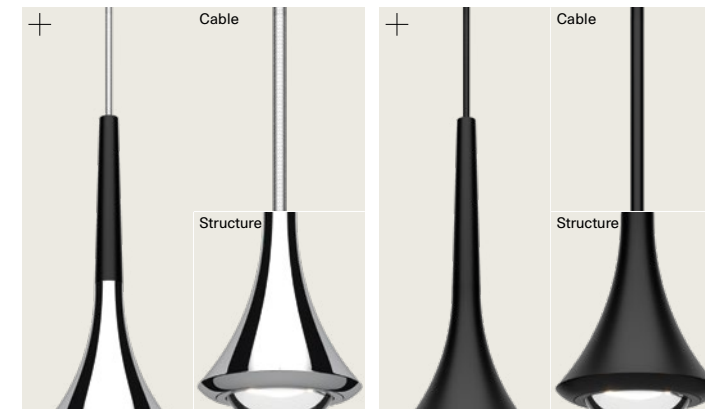

Cluster suspension lamp

Rain

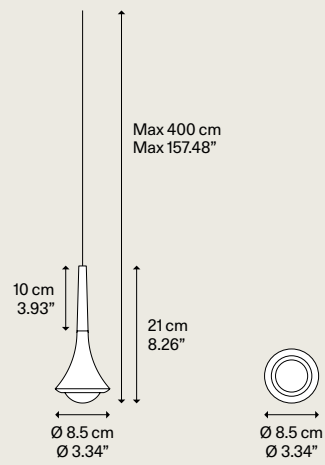

Light source Sorgente luminosa	Metal structure Montatura in metallo	Metal decor Decoro in metallo	Code Codice
LED ↘ 2700 K ↘ 7 W / 1280 lm ↘ 350 mA ↘ CRI 90 ↘ MacAdam 3-Step	Transparent cable Cavo Trasparente	● Matte Black - 9005 Nero Opaco - 9005	15611 2027
		● Coppery Bronze Bronzo Ramato	15611 3527
		● Chrome Cromo	15611 4727
		● Gold Oro	15611 5027
		● Rose Gold Oro Rosa	15611 5527
		● Matte Black - 9005 Nero Opaco - 9005	15612 2027
	Black cable Cavo Nero	● Coppery Bronze Bronzo Ramato	15612 3527
		● Brushed Chrome Cromo Spazzolato	15612 4727
		● Gold Oro	15612 5027
		● Rose Gold Oro Rosa	15612 5527
		● Matte Black - 9005 Nero Opaco - 9005	15611 2030
		● Coppery Bronze Bronzo Ramato	15611 3530
LED ↘ 3000 K ↘ 7 W / 1300 lm ↘ 350 mA ↘ CRI 90 ↘ MacAdam 3-Step	Transparent cable Cavo Trasparente	● Chrome Cromo	15611 4730
		● Gold Oro	15611 5030
		● Rose Gold Oro Rosa	15611 5530
		● Matte Black - 9005 Nero Opaco - 9005	15612 2030
		● Coppery Bronze Bronzo Ramato	15612 3530
		● Brushed Chrome Cromo Spazzolato	15612 4730
Black cable Cavo Nero	● Gold Oro	15612 5030	
	● Rose Gold Oro Rosa	15612 5530	
	● Matte Black - 9005 Nero Opaco - 9005	15611 2030	

LED and driver included
LED e driver inclusi

Net weight / Peso netto: 0.34 kg Pack / Colli: 2 Energy class / Classe energetica: C

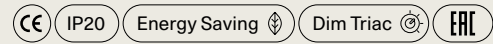

Suspension lamps must be installed on a canopy ▶ pag. 432-441
Le lampade a sospensione devono essere installate su rosone ▶ pag. 432-441

Ecodesign regulation ▶ pag. 444-445
Regolamento di Ecodesign ▶ pag. 444-445

Example of composition

Short Lights Track

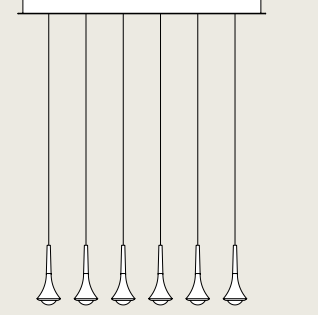
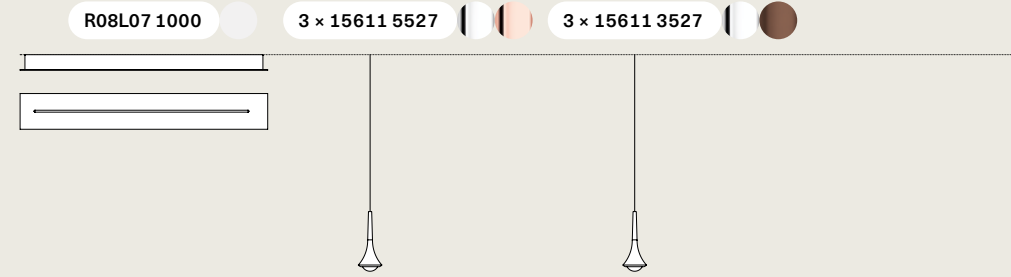

Example of composition

7 Lights Round

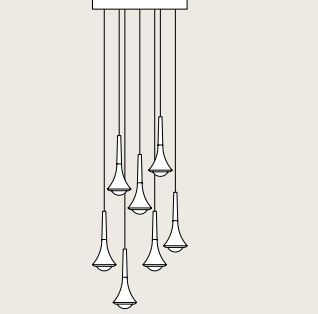
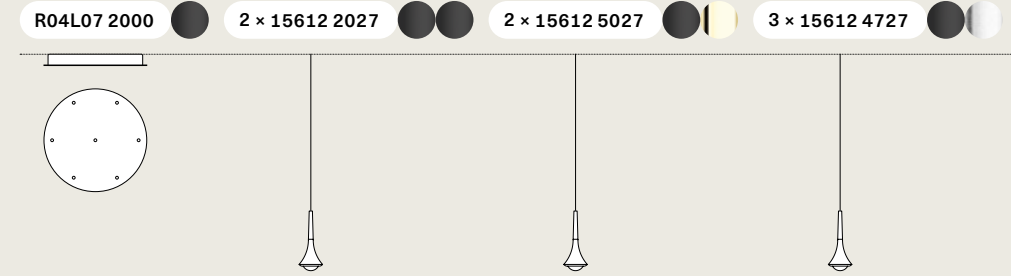

Example of composition

5-12 Lights Radial

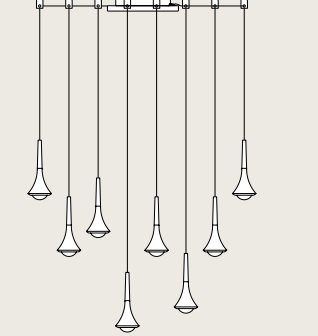
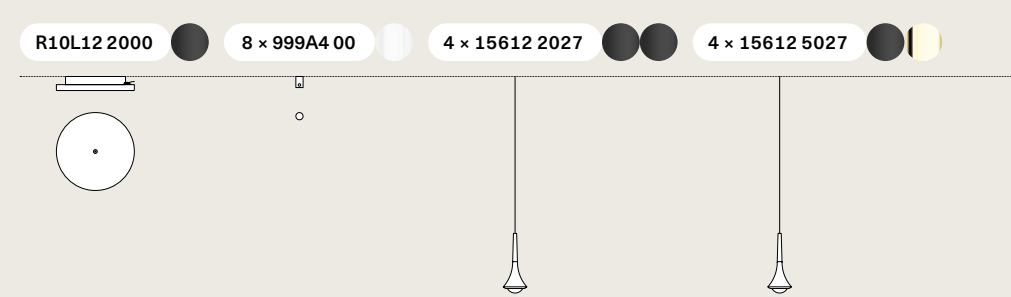

Spider

Spider is a round suspension lamp resembling an eye that can look into any part of the room. By adjusting the angle of the diffuser, the light beam emitted by the LED light can be directed towards any specific point. When installed on the different clusters available, it can create numerous lighting patterns, from functional to decorative, which can be dimmed at will. Now available in the new Terra finish and as ceiling light. In Spider, the simplicity of the looks underscores the versatility of its performance.

Spider è una lampada a sospensione sferica che ricorda un occhio che può guardare in qualsiasi punto della stanza. Regolando l'angolo del diffusore si può infatti dirigere il fascio di luce a LED su un particolare punto di interesse, mentre montata sui diversi cluster disponibili può creare molteplici schemi di luce, dal funzionale al decorativo, dimmerabili a piacere. Disponibile ora nella nuova finitura Terra e nella versione a soffitto. In Spider, la semplicità della forma esalta la versatilità delle prestazioni.

Cluster suspension lamp, Ceiling lamp

Spider,
FINISHES Terra and Matte Black

Spider, *design by* Andrea Tosetto, 2015/2022





Spider, FINISH Matte Black

1, 2



3, 4



1/4–Spider,
FINISHES Matte White, Matte Black,
Matte Champagne and Terra



Spider, FINISH Matte Black





Spider, single light on wall-mounted *radial canopy*, FINISH Matte White

Spider, composition of 6 lights on 5-12 lights *radial canopy*, FINISH Matte White and Chrome



Spider, single light on wall-mounted *radial canopy*, FINISH Matte White



Spider, FINISH Gold



Spider, FINISHES Terra
and Matte Black

CENTRE: composition of 4 lights
on 1-4 lights radial canopy

SIDES: single lights on
wall-mounted radial canopy



Spider, composition of 6 lights on 5-12 lights radial canopy, FINISH Matte Champagne

Spider est une suspension sphérique qui fait penser à un œil qui peut regarder n'importe où dans la pièce. En réglant l'angle du diffuseur, vous pouvez en effet diriger le faisceau de lumière LED vers un point d'intérêt particulier, tandis que montée sur les différents clusters disponibles, elle peut créer plusieurs schémas d'éclairage, du fonctionnel au décoratif, variables à souhait. Maintenant disponible dans la nouvelle finition Terra et en version plafonnrière. Dans Spider, la simplicité de la forme met en valeur la polyvalence des performances. ●FR

Spider ist eine kugelförmige Hängeleuchte, die an ein Auge erinnert, das jeden Punkt im Raum erblicken kann. Durch Einstellen des Winkels des Diffusors kann der LED-Lichtstrahl tatsächlich auf eine spezielle Stelle gerichtet werden, während durch die Kombination zu unterschiedlichen verfügbaren Clustern verschiedene Lichtschemata erstellt werden können - von funktionell bis dekorativ und nach Belieben dimmbar. Jetzt in der neuen Ausführung Terra und in der Deckenversion erhältlich. Bei Spider betont die Einfachheit der Form die vielseitigen Leistungen. ●DE

Spider es una lámpara colgante esférica que recuerda un ojo que puede mirar a cualquier punto de la habitación. Regulando el ángulo del difusor, de hecho, se puede dirigir el haz de luz de LED en un punto particular de interés, mientras que instalada en los diferentes sistemas cluster disponibles puede crear múltiples esquemas de luz, desde el funcional al decorativo, regulable a gusto. Ahora disponible en el nuevo acabado Terra y en la versión de techo. En Spider, la simplicidad de la forma exalta la versatilidad de las prestaciones. ●ES

Spider – это сферический подвесной светильник, напоминающий глаз, который может смотреть в любую точку помещения. Регулируя угол диффузора, можно направлять пучок светодиодного света на конкретную точку, а при установке в различных кластерах – создавать разнообразные схемы освещения, от функционального до декоративного, с возможностью регулировки яркости. Сейчас лампа выпускается с новой отделкой Terra и в форме потолочного плафона. Простота формы Spider подчеркивает его универсальность. ●RU

Spider是一款球形吊灯，像一只眼睛，可以望向房间里的每一个角落。调节灯罩的角度，可以把LED灯的光束调向特定角度，如安装在不同的组合吊上，可营造多重光幕，可满足从功能性到装饰性的需求，并根据喜好调光。吸顶灯版本的大地色饰面如今也可提供。Spider的简单造型彰显了其性能的广泛用途。●ZH

Visit website:



Spider » Cluster suspension lamp

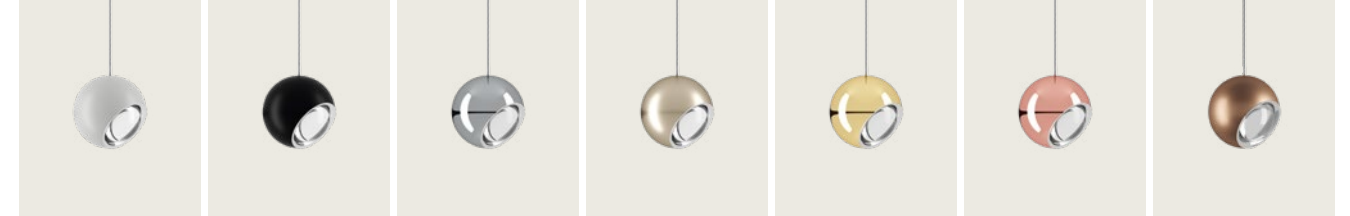

Spider » Ceiling lamp



Spider, design by Andrea Tosetto, 2015

Cluster suspension lamp

Spider

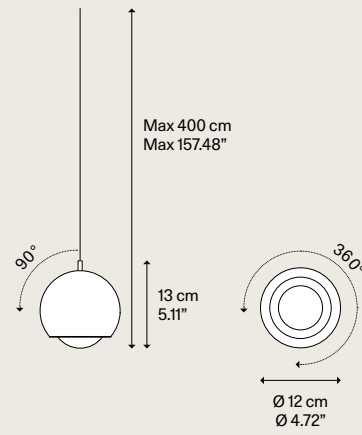

Light source Sorgente luminosa	Metal structure Montatura in metallo	Metal diffuser Diffusore in metallo	Code Codice
LED ↘ 2700 K ↘ 7 W/1280 lm ↘ 350 mA ↘ CRI 90 ↘ MacAdam 3-Step	Chrome Cromo	Matte White - 9010 Bianco Opaco - 9010	16010 1027
		Matte Black - 9005 Nero Opaco - 9005	16010 2027
		Chrome Cromo	16010 4027
		Matte Champagne Champagne Opaco	16010 4527
		Gold Oro	16010 5027
		Rose Gold Oro Rosa	16010 5527
		Terra Terra	16010 6727
		Matte White - 9010 Bianco Opaco - 9010	16010 1030
		Matte Black - 9005 Nero Opaco - 9005	16010 2030
		Chrome Cromo	16010 4030
LED ↘ 3000 K ↘ 7 W/1300 lm ↘ 350 mA ↘ CRI 90 ↘ MacAdam 3-Step	Chrome Cromo	Matte Champagne Champagne Opaco	16010 4530
		Gold Oro	16010 5030
		Rose Gold Oro Rosa	16010 5530
		Terra Terra	16010 6730

LED and driver included
LED e driver inclusi

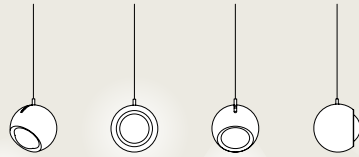

Adjustable light
Luce orientabile

Net weight/Peso netto: 0.8 kg Pack/Colli: 2 Energy class/Classe energetica: C

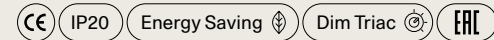

Suspension lamps must be installed on a canopy ▶ pag. 432-441
Le lampade a sospensione devono essere installate su rosone ▶ pag. 432-441

Ecodesign regulation ▶ pag. 444-445
Regolamento di Ecodesign ▶ pag. 444-445

Spider, design by Andrea Tosetto, 2022

Ceiling lamp

Spider

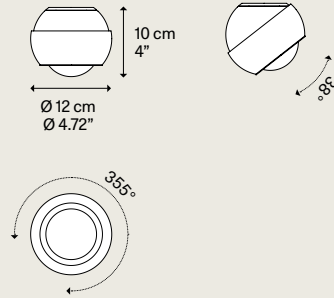

Light source Sorgente luminosa	Metal structure Montatura in metallo	Metal diffuser Diffusore in metallo	Code Codice	
LED ↘ 2700 K ↘ 10 W/920 lm ↘ 220-240 V ↘ CRI 90 ↘ MacAdam 3-Step	Chrome Cromo	Matte White - 9010 Bianco Opaco - 9010	18340 1027	
		Matte Black - 9005 Nero Opaco - 9005	18340 2027	
		Extra Matte Champagne Champagne Extra Opaco	18340 4527	
		Terra Terra	18340 6727	
		Matte White - 9010 Bianco Opaco - 9010	18340 1030	
		Matte Black - 9005 Nero Opaco - 9005	18340 2030	
		Extra Matte Champagne Champagne Extra Opaco	18340 4530	
		Terra Terra	18340 6730	
		LED included LED incluso		



Adjustable light
Luce orientabile

Net weight/Peso netto: 0.8 kg Pack/Colli: 2 Energy class/Classe energetica: F

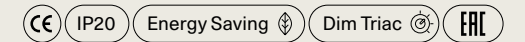

Ecodesign regulation ▶ pag. 444-445
Regolamento di Ecodesign ▶ pag. 444-445

LED sources with direct power supply
to the AC line voltage - driver not required.
Dimmable with phase cut dimmer.

LED con alimentazione diretta a tensione
di rete - non necessita di driver.
Dimmerabile con varialuce a taglio di fase.

Kelly Cluster

Kelly Cluster spectacularly reinterprets the creative intuition of the family of Kelly lights in a sculptural and extremely compact sphere, mounted on a canopy and allowing multiple different compositions at will. A suspension lamp in metal, characterised by its lightness and vibrancy thanks to the unique laser cuts that create captivating plays of light and shadow, it is available in four different finishes bringing any space to life.

Kelly Cluster riformula brillantemente l'intuizione creativa della famiglia di lampade Kelly in una sfera sculturale ed estremamente compatta che, montata su rosone, permette di realizzare composizioni multiple a piacere. Lampada a sospensione in metallo, leggera e vivace grazie ai particolari tagli a laser che creano affascinanti giochi di luci e ombre, è disponibile in quattro diverse finiture in grado di far risaltare qualsiasi ambiente.

Cluster suspension lamp

Kelly Cluster, FINISHES Coppery Bronze,
Matte Black and Matte Champagne

Kelly Cluster, *design by* Andrea Toso, 2015





Kelly Cluster, Special composition,
FINISH Matte White and Coppery Bronze



Kelly Cluster, composition of 10 lights on 5-12 lights radial canopy, FINISH Matte White



Kelly Cluster, composition of 14 lights
on a round canopy, FINISHES Matte Black
and Matte Champagne

Kelly Cluster reformule brillamment l'intuition créative de la famille de lampes Kelly dans une sphère sculpturale et extrêmement compacte qui, montée sur une patère, permet de réaliser d'innombrables compositions. Lampe à suspension en métal, légère et animée grâce aux originales découpes laser qui créent de fascinants jeux de lumière et d'ombres ; plusieurs finitions disponibles pour valoriser tous les espaces. ●FR

Kelly Cluster formuliert die kreative Intuition der Leuchtenfamilie Kelly auf brillante Weise in einer skulpturellen und besonders kompakten Kugel wieder, die auf einem Baldachin montiert die Umsetzung verschiedener Kombinationen nach Wahl ermöglicht. Hängeleuchte aus Metall, die dank besonderer Laserschnitte leicht und lebhaft ist. Sie sorgen außerdem für faszinierende Spiele aus Licht und Schatten. Die Leuchte ist in vier verschiedenen Ausführungen erhältlich, um jeden Raum aufzuwerten. ●DE

Kelly Cluster reformula brillantemente la intuición creativa de la familia de lámparas Kelly en una esfera escultural y extremadamente compacta que, montada en un florón, permite crear múltiples composiciones a voluntad. Lámpara colgante de metal, ligera y alegre gracias a los cortes especiales de láser que crean fascinantes juegos de luz y sombra, está disponible en cuatro acabados diferentes capaces de resaltar cualquier ambiente. ●ES

Kelly Cluster блестяще обыгрывает в новом ключе творческую интуицию, воплощенную в семействе светильников Kelly, выполненных в скульптурной и необыкновенно компактной форме шара, монтируя который на потолочное крепление можно создавать множественные композиции на свой вкус. Металлический подвесной светильник с изящным и динамичным дизайном благодаря особым прорезям, выполненным методом лазерной резки и создающим чарующую игру света и тени, доступен в четырёх разных вариантах отделки, которые украсят любой интерьер. ●RU

Kelly Cluster在一个雕塑般紧凑的球体中巧妙地重新构造了Kelly灯家族系列的创意直觉。该球体安装在底盘上，可让您根据需要创建多种组合。金属制成的吊灯，光线明亮、活泼，这要归功于其特殊的激光切割工艺，可以产生引人入胜的光影效果，并提供四种不同的颜色，可以烘托任何环境。●ZH

Visit website:



Kelly Cluster ▸ Cluster suspension lamp



Kelly Cluster, design by Andrea Tosetto, 2015

Cluster suspension lamp

Kelly Cluster

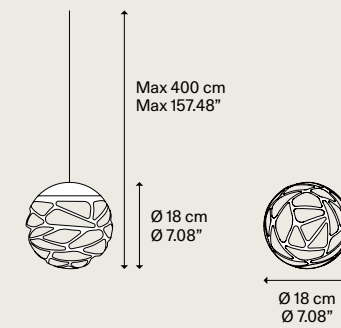

Light source
Sorgente luminosa

LED
▸ 2700 K
▸ 7 W / 1280 lm
▸ 350 mA
▸ CRI 90
▸ MacAdam 3-Step

LED and driver included
LED e driver inclusi

Metal structure
Montatura in metallo

- Matte White – 9010
Bianco Opaco – 9010
- Matte Black – 9005
Nero Opaco – 9005
- Coppery Bronze
Bronzo Ramato
- Matte Champagne
Champagne Opaco

Glass diffuser
Diffusore in vetro

- Glossy White
Bianco Lucido

Code
Codice

- 14711 1027
- 14711 2027
- 14711 3527
- 14711 4527

Net weight/Peso netto: 1 kg

Pack/Colli: 1

Energy class/Classe energetica: C

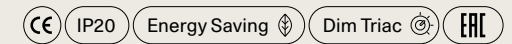

Suspension lamps must be installed on a canopy ▸ pag. 432-441
Le lampade a sospensione devono essere installate su rosone ▸ pag. 432-441

Ecodesign regulation ▸ pag. 444-445
Regolamento di Ecodesign ▸ pag. 444-445

Example of composition

3 Lights Round

R04L03 1000 1 × 14711 2027 1 × 14711 3527 1 × 14711 4527

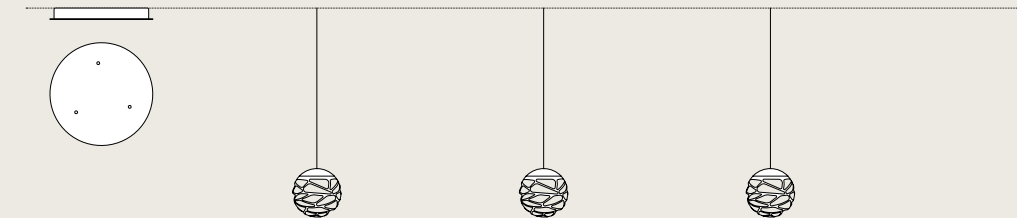

Example of composition

Short Lights Track

R08L07 1000 5 × 14711 4527

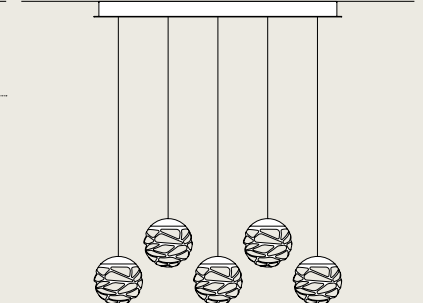
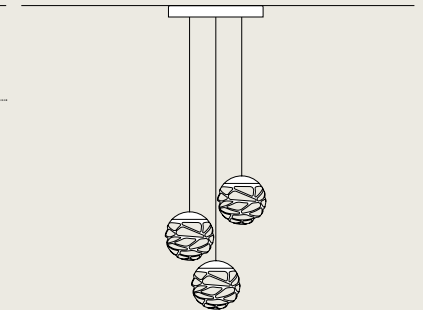

Kelly

Seductive beauty with a bold personality thanks to the strong and precise laser cuts, which lighten the metal of the lampshade and create an intriguing play of light and shadow. Kelly is a multifaceted family of suspension and wall lamps that stand out with elegance in any living space thanks to the variety of available forms and finishes.

Una bellezza seducente dalla personalità audace grazie a tagli laser forti e precisi che alleggeriscono il metallo del paralume e creano un intrigante gioco di luci e ombre. Kelly è una famiglia poliedrica di lampade a sospensione e a parete che si distingue con eleganza in ogni ambiente abitativo grazie alla varietà di forme e finiture disponibili.

Suspension lamp, Wall lamp

Kelly small dome 50, Kelly medium dome 60 and Kelly large dome 80, FINISH Matte White

Kelly, design by Andrea Tosetto, 2015

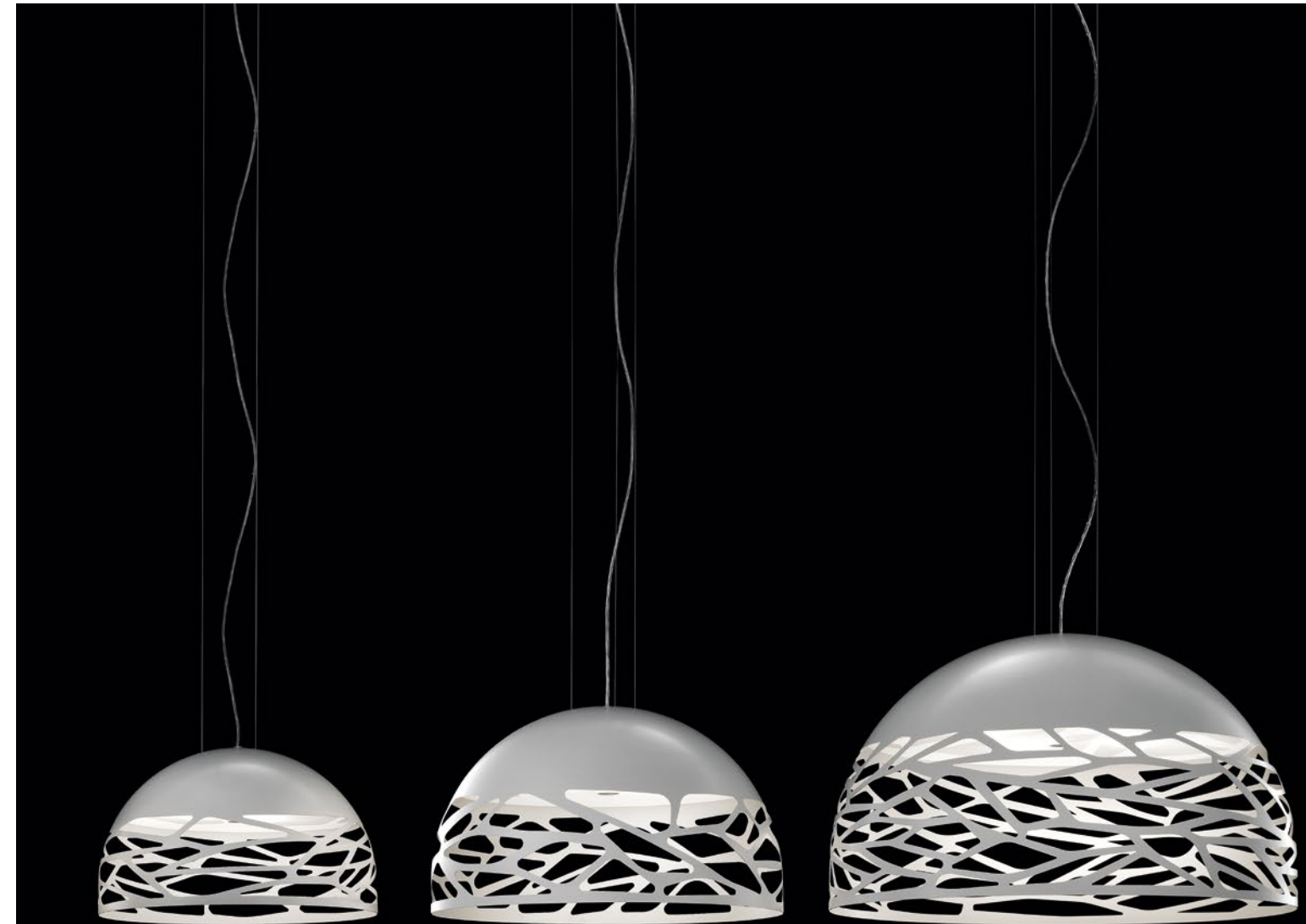

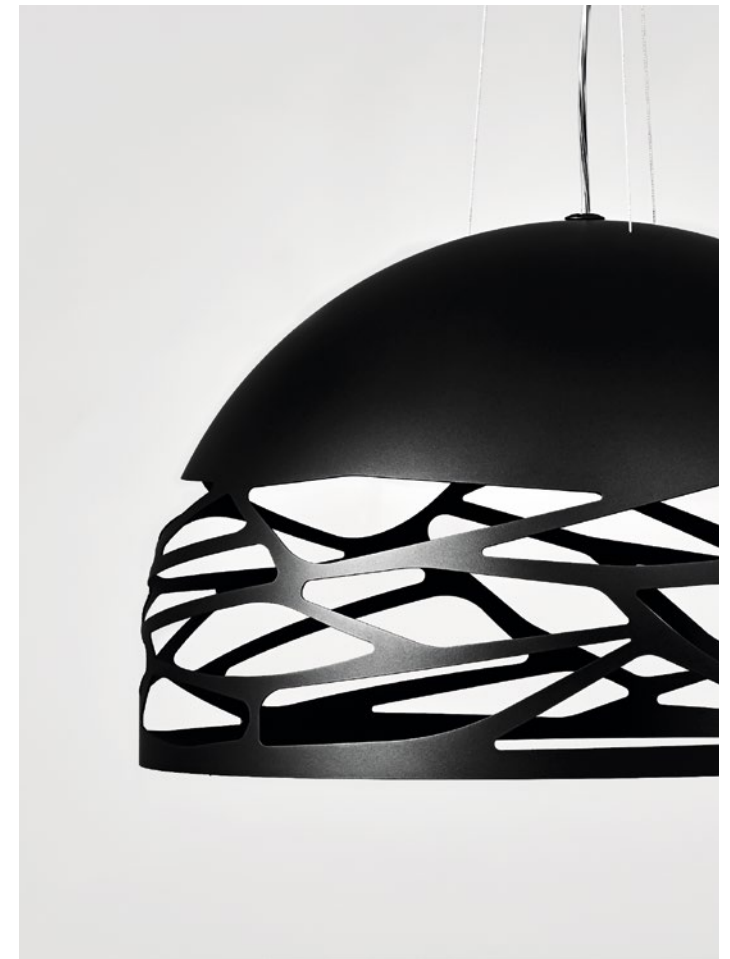

Kelly small dome 50, FINISH Matte Black

Kelly small dome 50,
FINISH Matte Black



Kelly small dome 50,
FINISH Coppery Bronze





Kelly, FINISH Matte White

Kelly large dome 80,
FINISH Matte Champagne





Kelly medium dome 60, FINISH Matte White

Kelly small sphere 40, Kelly medium sphere 50 and Kelly large sphere 80, FINISH Matte White



Kelly small sphere 40, Kelly medium sphere 50 and Kelly large sphere 80, FINISH Coppery Bronze

Une beauté séduisante d'une personnalité audacieuse grâce aux découpes laser puissantes et précises qui allègent le métal de l'abat-jour et créent un intrigant jeu de lumière et d'ombres. Kelly est une famille polyédrique de lampes à suspension et d'appliques qui se distingue avec élégance dans toutes les pièces de vie grâce à la variété de formes et de finitions disponibles. ● FR

Verführerische Schönheit mit gewagter Persönlichkeit, die durch starke und genaue Laserschnitte zum Ausdruck gebracht wird, die das Metall des Lampenschirms leicht erscheinen lassen und ein betrügerisches Spiel aus Licht und Schatten schaffen. Kelly ist eine vielseitige Familie aus Hänge- und Wandleuchten, die sich durch Eleganz in jedem Wohnraum auszeichnet, die den verschiedenen verfügbaren Formen und Ausführungen zu verdanken ist. ● DE

Una belleza seductora con una personalidad atrevida gracias a fuertes y precisos cortes de láser que iluminan el metal de la pantalla de la lámpara y crean un intrigante juego de luces y sombras. Kelly es una versátil familia de lámparas colgantes y de pared que destaca con elegancia en todos los entornos gracias a la variedad de formas y acabados disponibles. ● ES

Соблазнительная красота с решительным характером создана благодаря четким и выразительным прорезям, выполненным методом лазерной резки, которые облегчают металлический абажур и создают интригующую игру света и тени. Kelly – это семейство универсальных подвесных и настенных светильников, которые элегантно украшают любой жилой интерьер благодаря разнообразию доступных форм и отделок. ● RU

强劲而精确的激光切割使灯罩的金属发亮，并创造出有趣的光影效果，具有诱人的美感和大胆的个人性。Kelly是一个悬吊式和壁灯系列的产品，其多种多样的外形和颜色使其在任何生活环境中均格外高雅。● ZH

Visit website:



Kelly small dome 50 ↘ Suspension lamp



Kelly small sphere 40 ↘ Suspension lamp

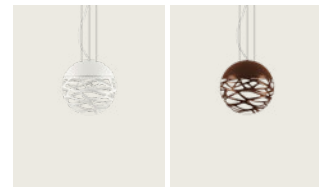

Kelly medium dome 60 ↘ Suspension lamp



Kelly medium sphere 50 ↘ Suspension lamp

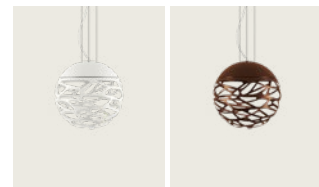

Kelly large dome 80 ↘ Suspension lamp



Kelly large sphere 80 ↘ Suspension lamp

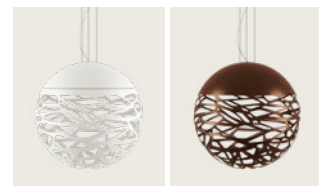

Kelly ↘ Wall lamp

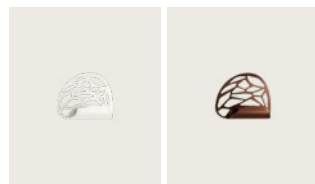

Kelly, design by Andrea Tosetto, 2015

Suspension lamp

Kelly small dome 50

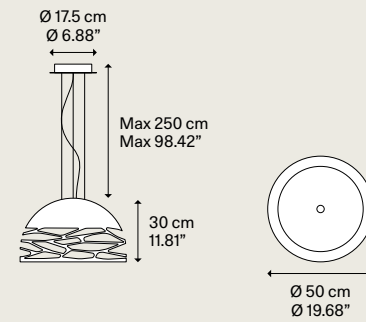

Net weight/Peso netto: 6 kg

Pack/Colli: 1

Light source Sorgente luminosa

E27 Classic A60
↘ 3 × max 46 W Eco



or

E27 LED
↘ 3 × 25 W



W/L max 12 cm
W/L max 4.72"

Bulbs not included
Lampadine non include

Metal structure Montatura in metallo

Matte White – 9010
Bianco Opaco – 9010

Matte Black – 9005
Nero Opaco – 9005

Coppery Bronze
Bronzo Ramato

Matte Champagne
Champagne Opaco

Glass diffuser Diffusore in vetro

Glossy White
Bianco Lucido

Code
Codice

14126 1000

14126 2000

14126 3500

14126 4500

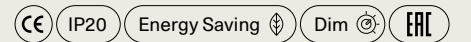

Kelly medium dome 60

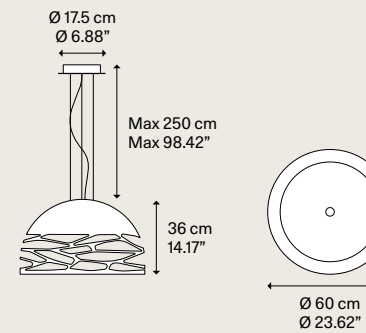

Net weight/Peso netto: 7.15 kg

Pack/Colli: 1

E27 Classic A60
↘ 3 × max 46 W Eco



or

E27 LED
↘ 3 × 25 W



W/L max 12 cm
W/L max 4.72"

Bulbs not included
Lampadine non include

Matte White – 9010
Bianco Opaco – 9010

Matte Black – 9005
Nero Opaco – 9005

Coppery Bronze
Bronzo Ramato

Matte Champagne
Champagne Opaco

Glossy White
Bianco Lucido

14127 1000

14127 2000

14127 3500

14127 4500

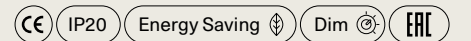

Kelly large dome 80

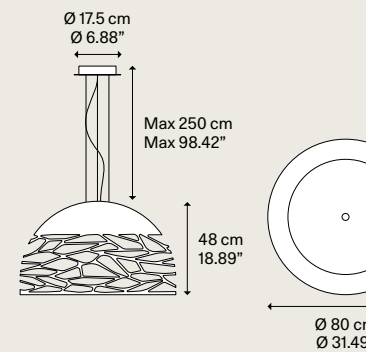

Net weight/Peso netto: 11 kg

Pack/Colli: 1

E27 Classic A60
↘ 4 × max 46 W Eco



or

E27 LED
↘ 4 × 25 W



W/L max 12 cm
W/L max 4.72"

Bulbs not included
Lampadine non include

Matte White – 9010
Bianco Opaco – 9010

Matte Black – 9005
Nero Opaco – 9005

Coppery Bronze
Bronzo Ramato

Matte Champagne
Champagne Opaco

Glossy White
Bianco Lucido

14128 1000

14128 2000

14128 3500

14128 4500

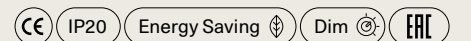

Kelly, design by Andrea Tosetto, 2015

Suspension lamp

Kelly small sphere 40

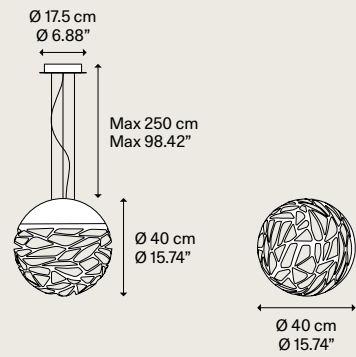

Light source Sorgente luminosa	Metal structure Montatura in metallo	Glass diffuser Diffusore in vetro	Code Codice
E27 Classic A60 ↘ 3 × max 46 W Eco	<input type="radio"/> Matte White – 9010 Bianco Opaco – 9010 <input type="radio"/> Coppery Bronze Bronzo Ramato	<input type="radio"/> Glossy White Bianco Lucido	14122 1000
<input type="radio"/> E27 LED ↘ 3 × 25 W	or		14122 3500
W/L max 12 cm W/L max 4.72"			
Bulbs not included Lampadine non incluse			

Net weight/Peso netto: 5.5 kg Pack/Colli: 2

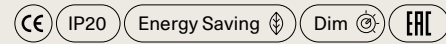

Kelly medium sphere 50

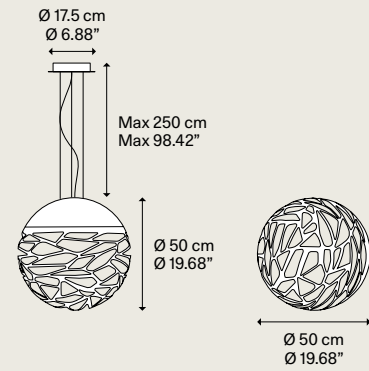

Light source Sorgente luminosa	Metal structure Montatura in metallo	Glass diffuser Diffusore in vetro	Code Codice
E27 Classic A60 ↘ 3 × max 46 W Eco	<input type="radio"/> Matte White – 9010 Bianco Opaco – 9010 <input type="radio"/> Coppery Bronze Bronzo Ramato	<input type="radio"/> Glossy White Bianco Lucido	14123 1000
<input type="radio"/> E27 LED ↘ 3 × 25 W	or		14123 3500
W/L max 12 cm W/L max 4.72"			
Bulbs not included Lampadine non incluse			

Net weight/Peso netto: 9 kg Pack/Colli: 2

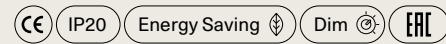

Kelly large sphere 80

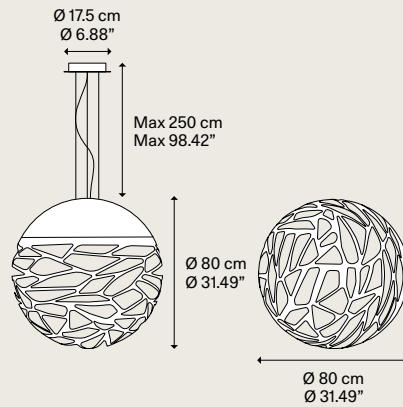

Light source Sorgente luminosa	Metal structure Montatura in metallo	Glass diffuser Diffusore in vetro	Code Codice
E27 Classic A60 ↘ 4 × max 46 W Eco	<input type="radio"/> Matte White – 9010 Bianco Opaco – 9010 <input type="radio"/> Coppery Bronze Bronzo Ramato	<input type="radio"/> Glossy White Bianco Lucido	14124 1000
<input type="radio"/> E27 LED ↘ 4 × 25 W	or		14124 3500
W/L max 12 cm W/L max 4.72"			
Bulbs not included Lampadine non incluse			

Net weight/Peso netto: 15 kg Pack/Colli: 2

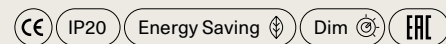

Kelly, design by Andrea Tosetto, 2015

Wall lamp

Kelly

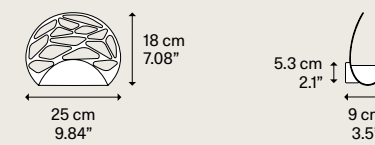

Light source Sorgente luminosa	Metal structure Montatura in metallo	Code Codice
LED ↘ 2700 K ↘ 15 W / 1750 lm ↘ 220-220 V ↘ CRI 92 ↘ MacAdam 3-Step	<input type="radio"/> Matte White – 9010 Bianco Opaco – 9010 <input type="radio"/> Coppery Bronze Bronzo Ramato	14150 1027
LED included LED incluso		14150 3527

Net weight/Peso netto: 0.8 kg Pack/Colli: 1 Energy class/Classe energetica: F



Ecodesign regulation ► pag. 444-445
Regolamento di Ecodesign ► pag. 444-445

JIM

Immediate function, uncomplicated style, durable materials, modular at will. Inspired by the abat-jours of the ateliers of the early 1900s, JIM is a system of suspension lamps with distinctive shapes and a versatile composition that suits any interiors and living environment. JIM's versatility is further enhanced by the colour range: the four different finishes for the shades can be combined with the two different suspension hook hues as desired.

Immediatezza di funzione, semplicità delle linee, materiali durevoli, componibilità a piacere. Ispirato ai paralumi degli atelier di artisti dell'inizio del 1900, JIM è un sistema di lampade a sospensione dalle forme distintive e dalla composizione versatile che si adatta a qualsiasi interno e ambiente abitativo. La versatilità di JIM è ulteriormente valorizzata dalla gamma cromatica: le quattro diverse finiture disponibili per i paralumi possono essere combinate a piacere con le due diverse tonalità del gancio a cui è sospesa la lampada.

Cluster suspension lamp, Suspension lamp

JIM bell, cylinder and cone,
FINISHES Matte White, Matte Champagne
and Coppery Bronze

JIM, *design by* Patrick Norguet, 2021





JIM cylinder, cone and bell, *single mini canopies*, FINISH Matte White



JIM cylinder, cone and bell, composition of 36 lights on a *round canopy*, FINISHES Matte Black and Matte Champagne



JIM bell, cylinder and cone, composition of 3 lights on a *round canopy*, FINISH Matte Black



JIM dome,
FINISH Matte Champagne



JIM dome, FINISH Coppery Bronze

Immédiateté de fonction, simplicité des lignes, matériaux durables, modularité en fonction des goûts personnels. S'inspirant des abat-jours des ateliers d'artistes du début du XXe siècle, JIM est un système de lampes à suspension encore plus la polyvalence de JIM : les quatre différentes finitions disponibles pour les diffuseurs peuvent s'associer, au choix, aux deux différentes tonalités du crochet de soutien. ● FR

Unmittelbarkeit der Funktion, Einfachheit der Linien, haltbare Materialien, Modularität nach Belieben. Inspiriert an den Lampenschirmen der Künstlerateliers der frühen 1900er Jahre, ist JIM ein Hängeleuchtensystem mit unverwechselbaren Formen und vielseitiger Gestaltungsmöglichkeit, das sich an jedes Interieur und jede Wohnumgebung anpasst. Die Vielseitigkeit von JIM wird durch die Farbpalette noch verstärkt: Die vier verschiedenen erhältlichen Ausführungen der Lampenschirme können beliebig mit den zwei verschiedenen Farbtönen des Hakens, an dem die Leuchte aufgehängt wird, kombiniert werden. ● DE

Inmediatez de función, líneas sencillas, materiales duraderos y modularidad sin límites. Inspirado en las pantallas de los ateliers de artistas de principios del siglo XX, JIM es un sistema de lámparas colgantes con formas características y composición versátil que se adapta a cualquier interior y ambiente. La versatilidad de JIM la valoriza aún más la gama cromática: los cuatro acabados distintos disponibles para las pantallas se pueden combinar sin límites con los dos tonos del gancho en el que se cuelga la lámpara. ● ES

Немедленно доступная функциональность, несложный стиль, прочные материалы, модульность по желанию. Лампа воспроизводит стиль абажуров творческих ателье начала 1900-х. JIM представляет собой систему подвесных ламп особой формы, с универсальной композицией, подходящей для любых внутренних интерьеров и дизайна жилья. Универсальность JIM дополнительно расширена благодаря диапазону цветов: четыре различных тональности абажуров сочетаются по желанию с двумя разными подвесными крюками. ● RU

功能即时、风格简洁、材料耐用、组合随意。灵感源于二十世纪初期艺术家工坊中的灯罩，JIM是一款形状独特且组合多样的悬吊灯系统，适宜于任何室内装饰与家居环境。JIM的通用性以其色彩范围之广越发增值：灯罩的四种不同饰面可按喜好与悬灯钩的两种不同色调相搭配。● ZH

Visit website:



JIM bell » Cluster suspension lamp

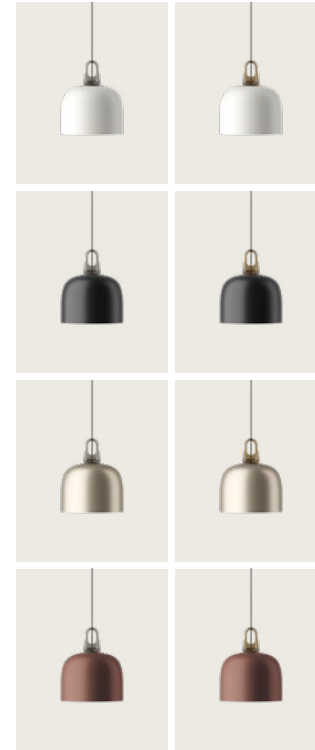

JIM cone » Cluster suspension lamp



JIM cylinder » Cluster suspension lamp



JIM dome » Suspension lamp

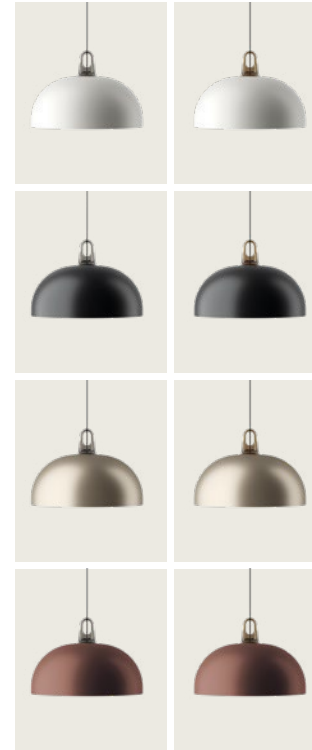

Grey hook
Gancio Grigio

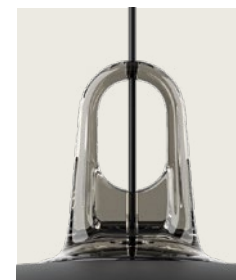

Honey hook
Gancio Miele

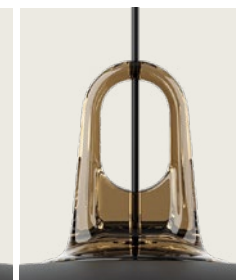

JIM, design by Patrick Norguet, 2021

Cluster suspension lamp

JIM bell

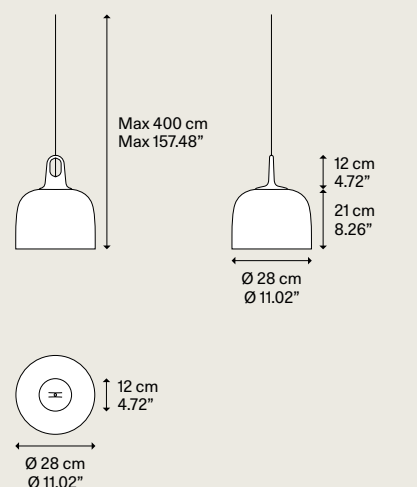

Light source Sorgente luminosa	Outside metal diffuser Diff. esterno in metallo	Inside metal diffuser Diff. interno in metallo	Hook methacrylate Gancio in metacrilato	Code Codice
E27 A60 LED 1 x 25 W	Matte White-9010 Bianco Opaco-9010	Matte White-9010 Bianco Opaco-9010	Grey Grigio	16921 2300
			Honey Miele	16921 6300
	Matte Black-9005 Nero Opaco-9005	Matte White-9010 Bianco Opaco-9010	Grey Grigio	16921 2800
			Honey Miele	16921 6600
	Matte Champagne Champagne Opaco	Matte White-9010 Bianco Opaco-9010	Grey Grigio	16921 2700
			Honey Miele	16921 6500
	Coppery Bronze Bronzo Ramato	Matte White-9010 Bianco Opaco-9010	Grey Grigio	16921 2400
			Honey Miele	16921 6400

Bulb not included
Lampadina non inclusa

Net weight/Peso netto: 1.9 kg Pack/Colli: 2

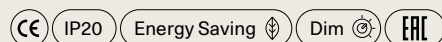

Suspension lamps must be installed on a canopy ► pag. 432-441
Le lampade a sospensione devono essere installate su rosone ► pag. 432-441

JIM cone

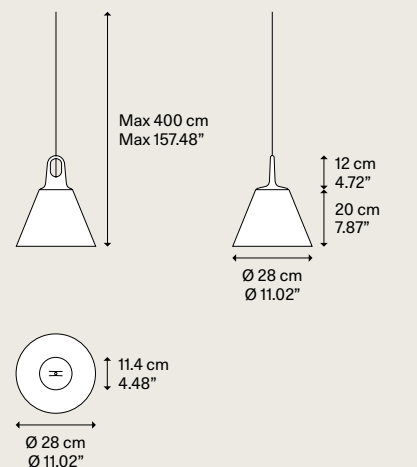

Light source Sorgente luminosa	Outside metal diffuser Diff. esterno in metallo	Inside metal diffuser Diff. interno in metallo	Hook methacrylate Gancio in metacrilato	Code Codice
E27 A60 LED 1 x 25 W	Matte White-9010 Bianco Opaco-9010	Matte White-9010 Bianco Opaco-9010	Grey Grigio	16922 2300
			Honey Miele	16922 6300
	Matte Black-9005 Nero Opaco-9005	Matte White-9010 Bianco Opaco-9010	Grey Grigio	16922 2800
			Honey Miele	16922 6600
	Matte Champagne Champagne Opaco	Matte White-9010 Bianco Opaco-9010	Grey Grigio	16922 2700
			Honey Miele	16922 6500
	Coppery Bronze Bronzo Ramato	Matte White-9010 Bianco Opaco-9010	Grey Grigio	16922 2400
			Honey Miele	16922 6400

Bulb not included
Lampadina non inclusa

Net weight/Peso netto: 1 kg Pack/Colli: 2

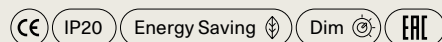

Suspension lamps must be installed on a canopy ► pag. 432-441
Le lampade a sospensione devono essere installate su rosone ► pag. 432-441

JIM, design by Patrick Norguet, 2021

Cluster suspension lamp

JIM cylinder

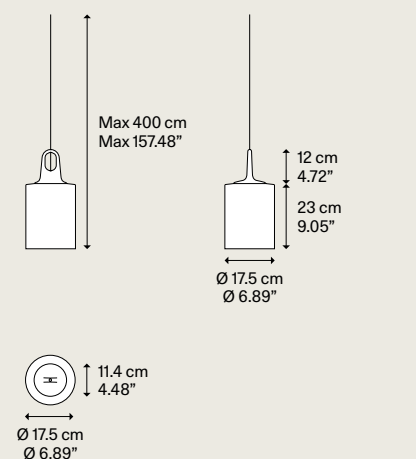

Light source Sorgente luminosa	Outside metal diffuser Diff. esterno in metallo	Inside metal diffuser Diff. interno in metallo	Hook methacrylate Gancio in metacrilato	Code Codice
E27 A60 LED 1 x 25 W	Matte White-9010 Bianco Opaco-9010	Matte White-9010 Bianco Opaco-9010	Grey Grigio	16923 2300
			Honey Miele	16923 6300
	Matte Black-9005 Nero Opaco-9005	Matte White-9010 Bianco Opaco-9010	Grey Grigio	16923 2800
			Honey Miele	16923 6600
	Matte Champagne Champagne Opaco	Matte White-9010 Bianco Opaco-9010	Grey Grigio	16923 2700
			Honey Miele	16923 6500
	Coppery Bronze Bronzo Ramato	Matte White-9010 Bianco Opaco-9010	Grey Grigio	16923 2400
			Honey Miele	16923 6400

Bulb not included
Lampadina non inclusa

Net weight/Peso netto: 1.4 kg Pack/Colli: 2

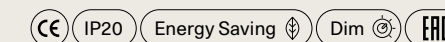

Suspension lamps must be installed on a canopy ► pag. 432-441
Le lampade a sospensione devono essere installate su rosone ► pag. 432-441

JIM, design by Patrick Norguet, 2021

Suspension lamp

JIM dome



Light source Sorgente luminosa	Outside metal diffuser Diff. esterno in metallo	Inside metal diffuser Diff. interno in metallo	Hook methacrylate Gancio in metacrilato	Code Codice
E27 A60 LED 1 x 25 W	Matte White-9010 Bianco Opaco-9010	Matte White-9010 Bianco Opaco-9010	Grey Grigio	16924 2300
			Honey Miele	16924 6300
	Matte Black-9005 Nero Opaco-9005	Matte White-9010 Bianco Opaco-9010	Grey Grigio	16924 2800
			Honey Miele	16924 6600
	Matte Champagne Champagne Opaco	Matte White-9010 Bianco Opaco-9010	Grey Grigio	16924 2700
			Honey Miele	16924 6500
	Coppery Bronze Bronzo Ramato	Matte White-9010 Bianco Opaco-9010	Grey Grigio	16924 2400
			Honey Miele	16924 6400

Bulb not included
Lampadina non inclusa

Net weight/Peso netto: 2.2 kg Pack/Colli: 2

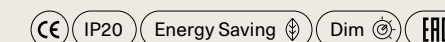

Volum

Volum is an exclusive series of glass lamps that are poetically simple yet complex in their technical execution. The four blown glass globes with glossy white finish come in different sizes measuring 14, 22, 29 and 42 cm in diameter. Thanks to their inherently distinct shapes, they intuitively complement one another to form unique compositions. Following last year's launch of the *Volum* suspension lamp, the collection has been revisited to include new ceiling, wall and table versions, further exploring the concept of 360° lighting. Enhanced by a fluid and discreet design, each *Volum* globe is closed by a methacrylate lid that lets light pass through evenly like glass does. In the new ceiling, wall and table versions, *Volum* features a glossy white diffuser and a silicone base that illuminates when the light is on.

Volum è una serie esclusiva di lampade in vetro poeticamente semplici seppur complesse nella loro realizzazione tecnica. Le quattro sfere in vetro soffiato, caratterizzate da una finitura bianca lucida, hanno dimensioni diverse che misurano 14, 22, 29 e 42 cm (diametro). Grazie alle loro forme intrinsecamente distinte si completano intuitivamente per creare composizioni uniche. Dopo il lancio della lampada a sospensione *Volum* lo scorso anno, la collezione è stata rivisitata per includere nuove lampade da soffitto, da parete e da tavolo, che esplorano ancor meglio il concetto di Illuminazione dello spazio a 360°. Valorizzata da un design fluido e discreto, ciascuna sfera *Volum* è chiusa da una calotta in metacrilato che lascia passare la luce in modo uniforme come il vetro. Nelle nuove versioni da soffitto, da parete e da tavolo, *Volum* è dotata di un diffusore con finitura bianca lucida e da una base in silicone che si illumina quando la luce è accesa.

Cluster suspension lamp, Suspension lamp,
Wall lamp, Ceiling lamp, Table lamp

Volum 29 cluster suspension lamp,
Volum 14, 22 wall lamp and Volum 14, 22, 29
and 42 table lamp, FINISH Glossy White

Volum, design by Snøhetta, 2022/2023





Volum 22 wall and table lamp, FINISH Glossy White

Volum 14, 22, 29 and 42
table lamp, FINISH Glossy White



Volum table lamp,
translucent silicone base

Volum 14, 22 table lamp and
Volum 22 cluster suspension lamp,
FINISH Glossy White





Volum 14, 22, 29 and 42 wall lamp
and Volum mirror 22 wall lamp,
FINISH Glossy White



1



2

1–Volum wall lamp,
translucent silicone structure
2–Volum ceiling lamp,
translucent silicone structure

Volum mirror 22 wall lamp,
FINISH Glossy White



171

Volum

Wall lamp, Ceiling lamp



Volum 14 wall lamp, FINISH Glossy White

Volum 14 wall lamp
and Volum 29 ceiling lamp,
FINISH Glossy White



Volum, the methacrylate lid lets light through the same way as the glass

Volum 14, 22 and 29, 2 × composition of 3 lights on a *round canopy* and single lights on *recessed micro canopies*, FINISHES Glossy White



Volum 14, 22 and 29, special composition of 475 lights on *recessed micro canopies*, FINISH Glossy White



Volum 29, 22, 14 and 42, FINISH Glossy White



Volum 42, FINISH Glossy White



Volum 14, 22, 29 and 42, special composition of 68 lights, FINISH Glossy White

Volum est une série exclusive de lampes en verre, d'une simplicité poétique mais complexes dans leur conception technique. Les quatre sphères en verre soufflé, caractérisées par une finition blanc brillant, présentent un diamètre différent de 14, 22, 29 et 42 cm. Grâce à leurs formes intrinsèquement différentes, elles se complètent intuitivement pour créer des compositions uniques. Après le lancement de la suspension *Volum* l'année passée, la collection a été repensée pour inclure de nouveaux plafonniers, appliques et lampes de table, qui explorent davantage le concept d'éclairage de l'espace à 360°. Sublimée par un design fluide et discret, chaque sphère *Volum* est close par une calotte en méthacrylate qui laisse passer la lumière aussi uniformément que du verre. Dans les nouvelles versions de plafonniers, d'appliques et de lampes de table, *Volum* est équipé d'un diffuseur avec finition blanc brillant et d'une base en silicone qui s'illumine lorsque la lumière est allumée. ● FR

Volum ist eine exklusive Serie von Glasleuchten, die poetisch einfach und doch komplex in ihrer technischen Umsetzung sind. Die vier mundgeblasenen Glaskugeln, die sich durch eine glänzende weiße Ausführung auszeichnen, haben unterschiedliche Abmessungen von 14, 22, 29 und 42 cm (Durchmesser). Dank ihrer von Natur aus unterschiedlichen Formen ergänzen sie sich intuitiv und ermöglichen es somit, einzigartige Kompositionen zu kreieren. Nach der Einführung der Hängeleuchte *Volum* im vergangenen Jahr wurde die Kollektion überarbeitet, um neue Decken-, Wand- und Tischleuchten einzuschließen, die das Konzept der 360°-Beleuchtung noch besser erkunden. Aufgewertet durch ein harmonisches und diskretes Design, wird jede *Volum*-Kugel von einer Methacrylatkappe umschlossen, die das Licht gleichmäßig wie Glas durchscheinen lässt. In den neuen Decken-, Wand- und Tischversionen ist *Volum* mit einem Diffusor in glänzend weißer Ausführung und einem Silikonsockel ausgestattet, der bei eingeschaltetem Licht leuchtet. ● DE

Volum es una serie exclusiva de lámparas de vidrio poéticamente simples a pesar de ser complejas por lo que respecta a su ejecución técnica. Las cuatro esferas de vidrio soplado, caracterizadas por un acabado blanco brillante, tienen distintos tamaños que miden 14, 22, 29 y 42 cm (diámetro). Gracias a sus formas intrínsecamente distintas se completan intuitivamente para crear composiciones únicas. Tras el lanzamiento de la lámpara colgante *Volum* el año pasado, la colección se ha renovado para incluir nuevas lámparas de techo, pared y sobremesa que exploran aún mejor el concepto de iluminación del espacio a 360°. Valorizada con un diseño fluido y discreto, cada esfera *Volum* se encuentra dentro de una carcasa de metacrilato que deja pasar la luz de manera uniforme como el vidrio. En las nuevas versiones de techo, pared y sobremesa, *Volum* cuenta con un difusor con acabado blanco brillante y una base de silicona que se ilumina cuando la luz está encendida. ● ES

Volum – это эксклюзивная серия стеклянных светильников, поэтически простых и, одновременно, сложных в техническом исполнении. Четыре сферы из выдувного стекла с блестящей белой отделкой имеют разные размеры: 14, 22, 29 и 42 см (в диаметре). Благодаря своим характерным формам эти сферы интуитивно дополняют друг друга, создавая уникальные композиции. После выпуска подвесной лампы *Volum* в прошлом году коллекция была доработана и дополнена новыми потолочными, настенными и настольными светильниками, которые ярче раскрывают концепцию освещения пространства на 360°. Каждая сфера *Volum*, отличающаяся текучим и сдержанным дизайном, закрыта куполом из метакрилата, равномерно пропускающим свет, также, как и стекло. Новые варианты потолочных, настенных и настольных светильников *Volum* оборудованы диффузором с блестящей белой отделкой и силиконовым основанием, светящимся при включенном свете. ● RU

Volum 是一款独一无二的玻璃灯系列，其技术构造在诗意般简约的同时亦是完备无缺的。四只吹制玻璃球体以亮光白色饰面为其特征，具有分别为14、22、29和42厘米(直径)的不同尺寸。得益于其本质上各不相同的形状，它们能够直观地相互补充，以创造独特的组合。继去年推出的*Volum*悬吊灯后，该系列受到了重审，以包含能够进一步拓展360度空间照明理念的全新吸顶灯、壁灯和台灯。流畅谨慎的设计为其赋予价值，每只*Volum*球体都被一只甲基丙烯酸酯盖帽所封闭，使光线能够像玻璃一样均匀穿过。在全新吸顶灯、壁灯及台灯版本中，*Volum*配有一个有着亮光白色饰面和硅胶底座的漫射器，灯打开时便会亮起。● ZH

Visit website:



Volum 14, 22, 29 ▸ Cluster suspension lamp



Volum 42 ▸ Suspension lamp

Volum 14, 22, 29, 42 ▸ Ceiling lamp, Wall lamp **NEW LAMP**

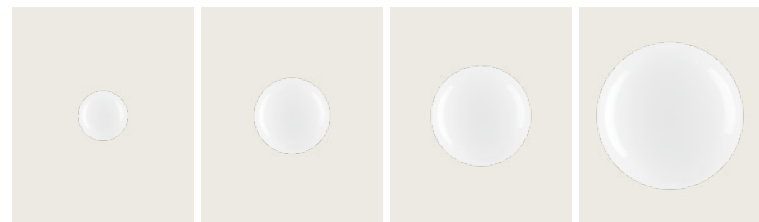

Volum 14, 22, 29, 42 ▸ Table lamp **NEW LAMP**



Volum, design by Snøhetta, 2022

Cluster suspension lamp

Volum 14

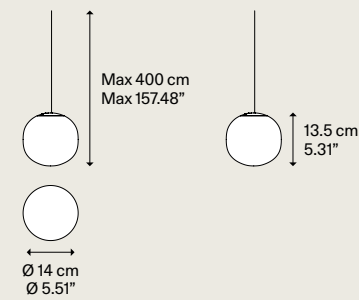

Net weight/Peso netto: 0.90 kg

Pack/Colli: 2

Light source
Sorgente luminosa

E14 LED
≈ 1 × 15 W

Ø max 6 cm – 2.36"

W/L max 8 cm
W/L max 3.14"

Bulb not included
Lampadina non inclusa

Methacrylate structure
Struttura in metacrilato

Glossy White
Bianco Lucido

Blown glass diffuser
Diffusore in vetro soffiato

Glossy White
Bianco Lucido

Code
Codice

18711 1200

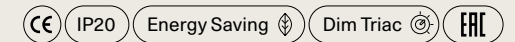

Volum 22

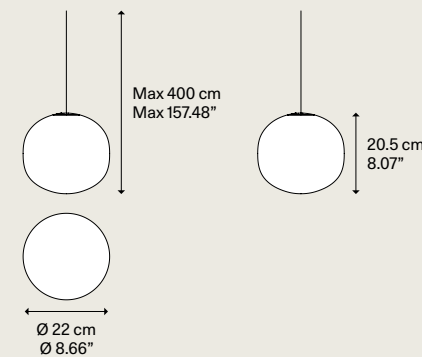

Net weight/Peso netto: 1.50 kg

Pack/Colli: 2

E27 LED
≈ 1 × 25 W

Ø max 6 cm – 2.36"

W/L max 11 cm
W/L max 4.33"

Bulb not included
Lampadina non inclusa

Glossy White
Bianco Lucido

Glossy White
Bianco Lucido

18712 1200

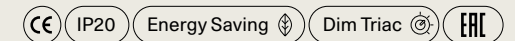

Volum 29

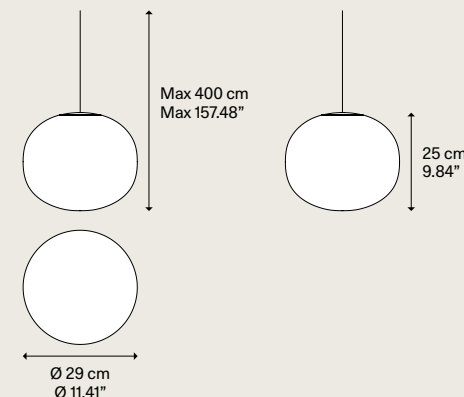

Net weight/Peso netto: 2.20 kg

Pack/Colli: 2

E27 LED
≈ 1 × 25 W

Ø max 9.8 cm – 3.74"

Bulb not included
Lampadina non inclusa

Glossy White
Bianco Lucido

Glossy White
Bianco Lucido

18713 1200

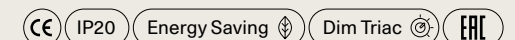

Suspension lamps must be installed on a canopy ▶ pag. 432–441
Le lampade a sospensione devono essere installate su rosone ▶ pag. 432–441

Volum, design by Snøhetta, 2022

Cluster suspension lamp

Example of composition 3 Lights Round

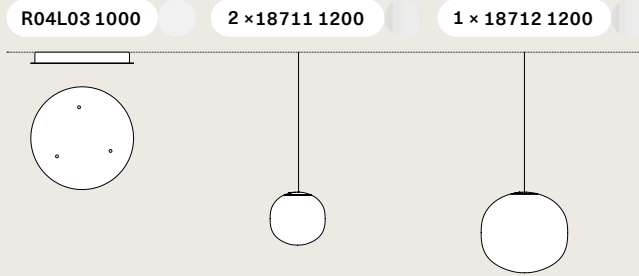

Example of composition 5-12 Lights Radial

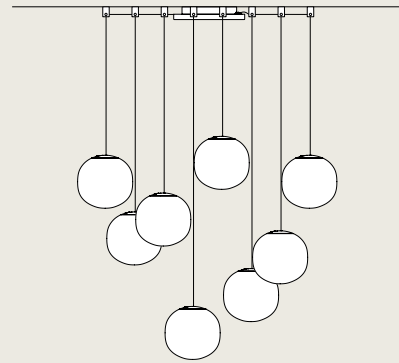
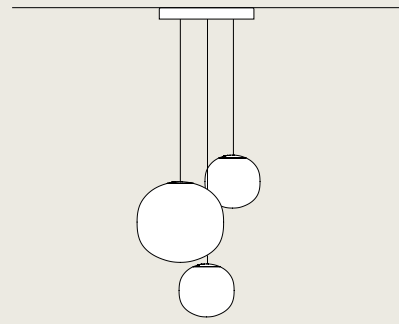
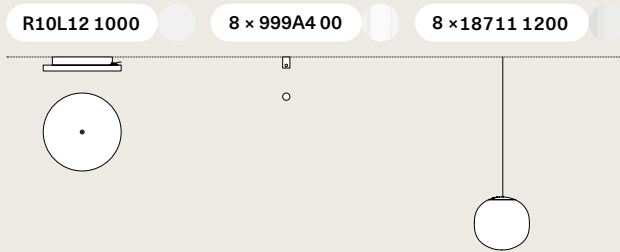

Suspension lamps must be installed on a canopy ▶ pag. 432-441
Le lampade a sospensione devono essere installate su rosone ▶ pag. 432-441

Volum, design by Snøhetta, 2022

Suspension lamp

Volum 42

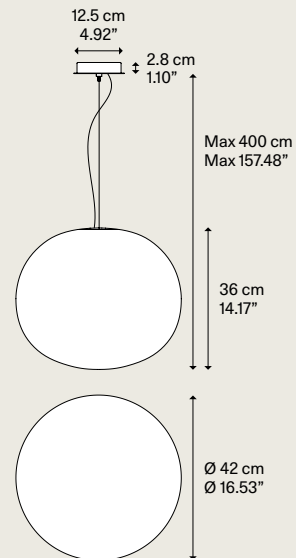

Light source Sorgente luminosa	Methacrylate structure Struttura in metacrilato	Blown glass diffuser Diffusore in vetro soffiato	Code Codice
E27 LED ↘ 1 × 25 W Ø max 9.8 cm Ø max 3.74" Bulb not included Lampadina non inclusa	Glossy White Bianco Lucido	Glossy White Bianco Lucido	18720 1200

Net weight/Peso netto: 4 kg Pack/Colli: 2

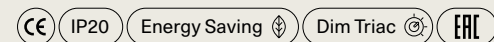

Volum, design by Snøhetta, 2023

Wall lamp Ceiling lamp

Volum 14 NEW

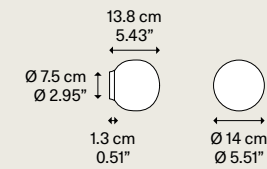

Light source Sorgente luminosa	Silicone structure Struttura in silicone	Blown glass diffuser Diffusore in vetro soffiato	Code Codice
E14 LED ↘ 1 × 15 W Ø max 5 cm - 1.96" W/L max 9 cm - 3.54" Bulb not included Lampadina non inclusa	Translucent Traslucido	Glossy White Bianco Lucido	18741 1200

Net weight/Peso netto: 0.74 kg Pack/Colli: 2



Volum 22 NEW

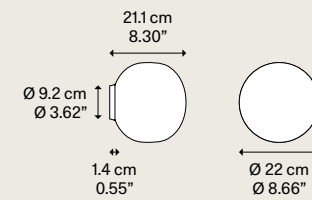

Light source Sorgente luminosa	Silicone structure Struttura in silicone	Blown glass diffuser Diffusore in vetro soffiato	Code Codice
E27 LED ↘ 1 × 25 W Ø max 5 cm - 1.96" W/L max 12.5 cm - 4.92" Bulb not included Lampadina non inclusa	Translucent Traslucido	Glossy White Bianco Lucido	18742 1200

Net weight/Peso netto: 1.15 kg Pack/Colli: 2

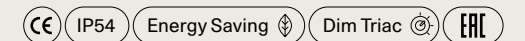

Volum 29 NEW

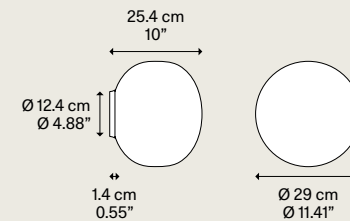

Light source Sorgente luminosa	Silicone structure Struttura in silicone	Blown glass diffuser Diffusore in vetro soffiato	Code Codice
E27 LED ↘ 1 × 25 W Ø max 8.5 cm - 3.34" Bulb not included Lampadina non inclusa	Translucent Traslucido	Glossy White Bianco Lucido	18743 1200

Net weight/Peso netto: 2.16 kg Pack/Colli: 2

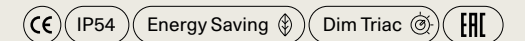

Volum 42 NEW

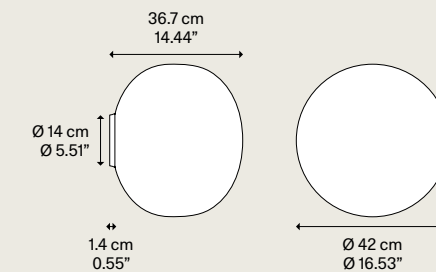

Light source Sorgente luminosa	Silicone structure Struttura in silicone	Blown glass diffuser Diffusore in vetro soffiato	Code Codice
E27 LED ↘ 1 × 25 W Ø max 8.5 cm - 3.34" Bulb not included Lampadina non inclusa	Translucent Traslucido	Glossy White Bianco Lucido	18744 1200

Net weight/Peso netto: 3.39 kg Pack/Colli: 2

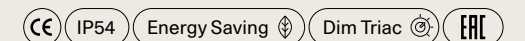

Wall lamp

Volum mirror 14 NEW

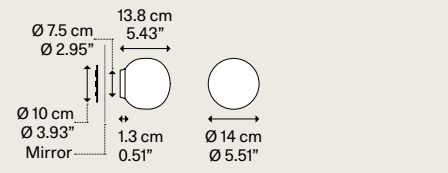

Light source Sorgente luminosa	Silicone structure Struttura in silicone	Blown glass diffuser Diffusore in vetro soffiato	Code Codice
E14 LED 1 × 15 W	Translucent Traslucido	Glossy White Bianco Lucido	18741 120S
Ø max 5 cm – 1.96" W/L max 9 cm – 3.54"			
Bulb not included Lampadina non inclusa			

Net weight/Peso netto: 0.74 kg Pack/Colli: 2

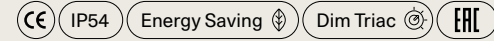

Volum mirror 22 NEW

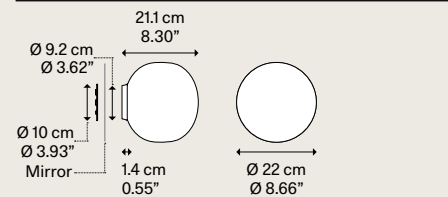

Light source Sorgente luminosa	Silicone structure Struttura in silicone	Blown glass diffuser Diffusore in vetro soffiato	Code Codice
E27 LED 1 × 25 W	Translucent Traslucido	Glossy White Bianco Lucido	18742 120S
Ø max 5 cm – 1.96" W/L max 12.5 cm – 4.92"			
Bulb not included Lampadina non inclusa			

Net weight/Peso netto: 1.15 kg Pack/Colli: 2

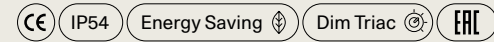

Volum mirror 29 NEW

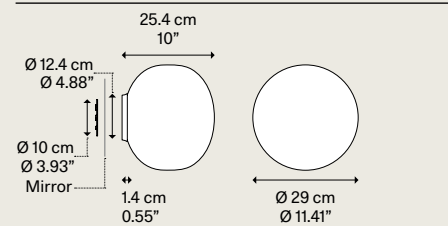

Light source Sorgente luminosa	Silicone structure Struttura in silicone	Blown glass diffuser Diffusore in vetro soffiato	Code Codice
E27 LED 1 × 25 W	Translucent Traslucido	Glossy White Bianco Lucido	18743 120S
Ø max 8.5 cm – 3.34"			
Bulb not included Lampadina non inclusa			

Net weight/Peso netto: 2.16 kg Pack/Colli: 2

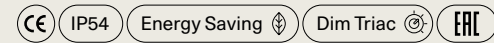

Volum mirror 42 NEW

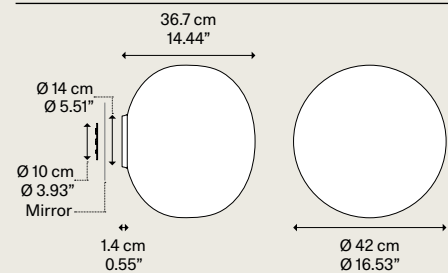

Light source Sorgente luminosa	Silicone structure Struttura in silicone	Blown glass diffuser Diffusore in vetro soffiato	Code Codice
E27 LED 1 × 25 W	Translucent Traslucido	Glossy White Bianco Lucido	18744 120S
Ø max 8.5 cm – 3.34"			
Bulb not included Lampadina non inclusa			

Net weight/Peso netto: 3.39 kg Pack/Colli: 2

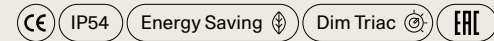

Application
Applicazione

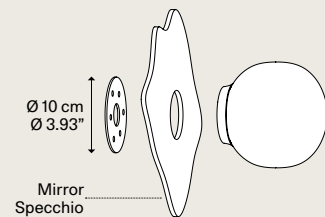
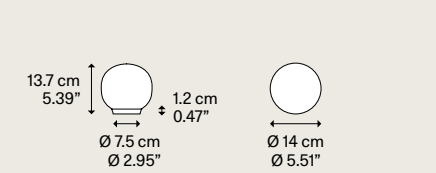

Table lamp

Volum 14 NEW



Light source Sorgente luminosa	Silicone base Base in silicone	Blown glass diffuser Diffusore in vetro soffiato	Code Codice
E14 LED 1 × 15 W Ø max 6 cm – 2.36" W/L max 9 cm – 3.54"	Translucent Traslucido	Glossy White Bianco Lucido	18781 1200
Bulb not included Lampadina non inclusa			
On/Off Switch the cord Interuttore On/Off sul cavo			

E14 LED 1 × 15 W Ø max 6 cm – 2.36" W/L max 9 cm – 3.54"	Translucent Traslucido	Glossy White Bianco Lucido	18781 120D
Bulb not included Lampadina non inclusa			
Dimmer switch on the cord Interuttore con dimmer sul cavo			

Net weight/Peso netto: 0.71 kg Pack/Colli: 2

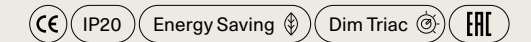

Volum 22 NEW

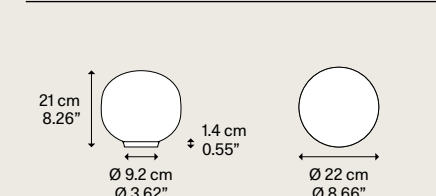

Light source Sorgente luminosa	Silicone base Base in silicone	Blown glass diffuser Diffusore in vetro soffiato	Code Codice
E27 LED 1 × 25 W Ø max 6 cm – 2.36" W/L max 12.5 cm – 4.92"	Translucent Traslucido	Glossy White Bianco Lucido	18782 1200
Bulb not included Lampadina non inclusa			
On/Off Switch the cord Interuttore On/Off sul cavo			

E27 LED 1 × 25 W Ø max 6 cm – 2.36" W/L max 12.5 cm – 4.92"	Translucent Traslucido	Glossy White Bianco Lucido	18782 120D
Bulb not included Lampadina non inclusa			
Dimmer switch on the cord Interuttore con dimmer sul cavo			

Net weight/Peso netto: 1.19 kg Pack/Colli: 2

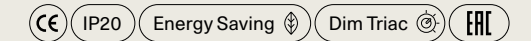

Volum 29 NEW

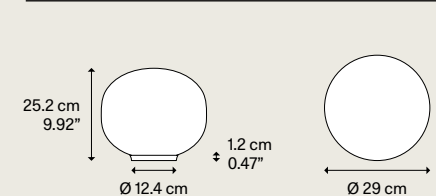

Light source Sorgente luminosa	Silicone base Base in silicone	Blown glass diffuser Diffusore in vetro soffiato	Code Codice
E27 LED 1 × 25 W Ø max 9.8 cm – 3.85"	Translucent Traslucido	Glossy White Bianco Lucido	18783 1200
Bulb not included Lampadina non inclusa			
On/Off Switch the cord Interuttore On/Off sul cavo			

E27 LED 1 × 25 W Ø max 9.8 cm – 3.85"	Translucent Traslucido	Glossy White Bianco Lucido	18783 120D
Bulb not included Lampadina non inclusa			
Dimmer switch on the cord Interuttore con dimmer sul cavo			

Net weight/Peso netto: 2.06 kg Pack/Colli: 2

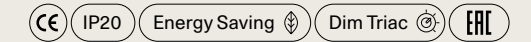

Volum 42 NEW

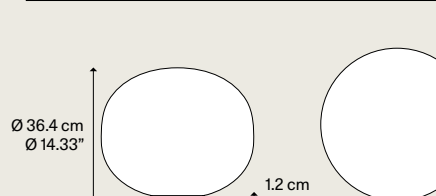

Light source Sorgente luminosa	Silicone base Base in silicone	Blown glass diffuser Diffusore in vetro soffiato	Code Codice
E27 LED 1 × 25 W Ø max 9.8 cm – 3.85"	Translucent Traslucido	Glossy White Bianco Lucido	18784 1200
Bulb not included Lampadina non inclusa			
On/Off Switch the cord Interuttore On/Off sul cavo			

E27 LED 1 × 25 W Ø max 9.8 cm – 3.85"	Translucent Traslucido	Glossy White Bianco Lucido	18784 120D
Bulb not included Lampadina non inclusa			
Dimmer switch on the cord Interuttore con dimmer sul cavo			

Net weight/Peso netto: 3.34 kg Pack/Colli: 2

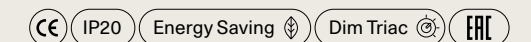

Random

A lightweight, blown glass suspension light, Random is made up of three round diffusers of different sizes which form one simple, eye-catching whole. Each diffuser has an LED light source which emits warm white light. When grouped together on a cluster, Random light fixtures form a poetic composition like soap bubbles, enhanced by the glossy coloured finishes which add a touch of character and originality.

Leggerissima lampada a sospensione in vetro soffiato, Random è composta da tre diffusori sferici di dimensioni diverse che formano un'entità semplice e vivace. Ogni diffusore è dotato di una sorgente luminosa a LED che fornisce una calda luce bianca. Raggruppate su cluster le lampade Random danno vita a composizioni poetiche come giochi di bolle di sapone, che le finiture lucide sfumate arricchiscono di carattere e originalità.

Cluster suspension lamp

Random, FINISHES Glossy Smoke
and Glossy Bronze

Random, *design by Chia-Ying Lee, 2017*





Random, composition of 7 lights on a *long track*,
FINISHES Glossy Smoke and Clear



Random, FINISH Glossy Bronze

Random, *recessed micro canopy*,
FINISHES Glossy Bronze and Clear



Random, composition of 7 lights on a *rectangular canopy*, FINISHES Glossy Bronze and Chrome

Random, *recessed micro canopy*, FINISHES Glossy Bronze and Chrome



Random, FINISH Frosted White



Random, composition of 36 lights on a round canopy, FINISHES Clear and Chrome



Random, composition of 6 lights on 5-12 lights radial canopy, FINISHES Frosted White and Gold

Random, recessed micro canopies, FINISH Clear



Random, composition of 14 lights
on a *rectangular canopy*, FINISH Rose Gold



Random, FINISH Rose Gold

Suspension très légère en verre soufflé, Random est composée de trois diffuseurs sphériques de différentes tailles formant une entité simple et vivante. Chaque diffuseur est équipé d'une source lumineuse LED qui fournit une lumière blanche chaude. Regroupées en cluster, les lampes Random donnent vie à des compositions poétiques telles que des jeux de bulles de savon, dont les finitions douces et ombragées enrichissent le caractère et l'originalité. ● FR

Random ist eine ultraleichte Hängeleuchte aus geblasenem Glas und besteht aus drei kugelförmigen Diffusoren in unterschiedlicher Größe, die eine einfache und lebhafte Einheit bilden. Jeder Diffusor verfügt über eine LED-Lichtquelle, die warmweißes Licht abstrahlt. In Clustern angeordnet, lassen die Leuchten Random poetische Kombinationen entstehen, die einem Spiel aus Seifenblasen ähneln und denen die glänzenden, nuancierten Ausführungen Charakter und Originalität verleihen. ● DE

Lámpara muy ligera colgante de vidrio soplado, Random está compuesta de tres difusores esféricos de diferentes dimensiones que forman una entidad simple y dinámica. Cada difusor está equipado con una fuente luminosa de LED que proporciona una luz blanca cálida. Reagrupadas en grupos de lámparas colgantes Random dan vida a composiciones poéticas como juegos de pompas de jabón, que los acabados brillantes matizados enriquecen con carácter y originalidad. ● ES

Random – это легкий подвесной светильник из выдувного стекла, состоящий из трех сферических диффузоров разных размеров, которые образуют простую и живую композицию. Каждый диффузор оснащен светодиодным источником теплого белого света. Объединенные в кластеры лампы Random дают жизнь восхитительным композициям, таким как игра мыльных пузырей, а глянцевая отделка придает им своеобразный характер и оригинальность. ● RU

Random是一款非常轻盈的吹制玻璃吊灯，由三个不同尺寸的球形灯罩组成，形成简单活泼的整体。每一个灯罩都配有一个LED光源，提供白色的温暖灯光。集中在组合吊上，Random灯可形成诗意的组合，如同肥皂泡的嬉戏，光亮的色泽丰富了个性与原创性。● ZH

Visit website:



Random, design by Chia-Ying Lee, 2017

Cluster suspension lamp

Random

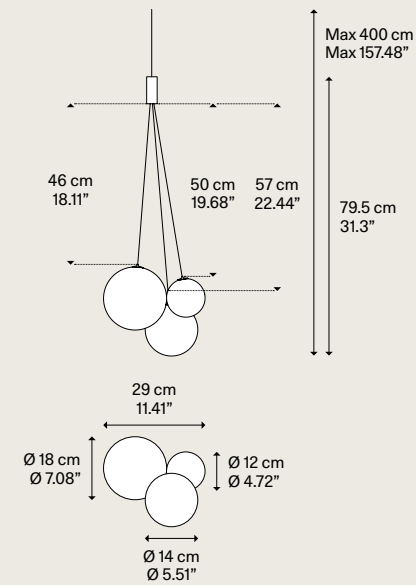

Light source
Sorgente luminosa

LED
 ▾ 2700 K
 ▾ 3 × 1 W / 450 lm
 ▾ 350 mA
 ▾ CRI 90
 ▾ MacAdam 3-Step

Metal structure
Montatura in metallo

Chrome
Cromo

Blown glass diffuser	Diffusore in vetro soffiato	Code
Clear	Trasparente	16410 0027
Frosted White	Bianco Satinato	16410 1327
Chrome	Cromo	16410 4027
Glossy Smoke	Fumo Lucido	16410 4327
Glossy Bronze NEW	Bronzo Lucido	16410 4627
Gold	Oro	16410 5027
Rose Gold	Oro Rosa	16410 5527
Clear	Trasparente	16410 0030
Frosted White	Bianco Satinato	16410 1330
Chrome	Cromo	16410 4030
Glossy Smoke	Fumo Lucido	16410 4330
Glossy Bronze NEW	Bronzo Lucido	16410 4630
Gold	Oro	16410 5030
Rose Gold	Oro Rosa	16410 5530

LED and driver included
LED e driver inclusi

Net weight/Peso netto: 1.0 kg

Pack/Coll: 2

Energy class/Classe energetica: D

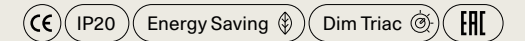

Suspension lamps must be installed on a canopy ► pag. 432-441
Le lampade a sospensione devono essere installate su rosone ► pag. 432-441

Ecodesign regulation ► pag. 444-445
Regolamento di Ecodesign ► pag. 444-445

Random ▾ Cluster suspension lamp

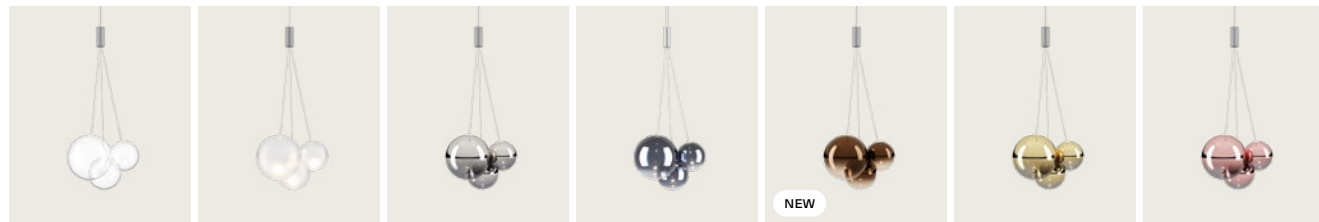

Finishes ▾ Gradient effect

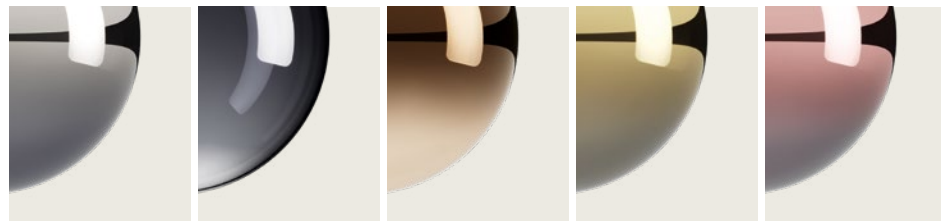

Example of composition

5-12 Lights Radial

R10L12 1000

8 × 999A4 00

4 × 16410 0027

4 × 16410 4627

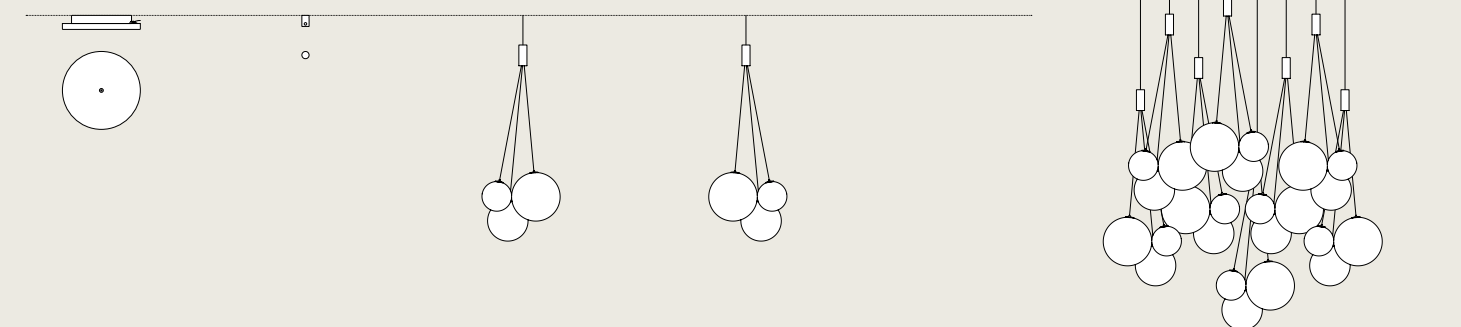

Random Solo

Five perfect spheres floating in the air like gentle glass bubbles. Random Solo revisits the concept of the Random suspension lamp by parting the original three-piece cluster and adding two new blown glass spheres. The five sizes and seven different finishes available offer ample styling freedom, both as individually suspended light points and in lightweight and lively combinations on clusters. The fingerprint resistant frosted white finish magically changes the perception of the sphere and its volume, opening new opportunities for interior decoration, while the new Glossy Bronze finish is synonymous with alluring beauty, that inspires stability and infuses calmness to any living environments.

Cinque sfere perfette che fluttuano nell'aria come leggere bolle di vetro. Random Solo rivisita il concetto della lampada a sospensione Random separando l'originale cluster a tre elementi e aggiungendo due nuove sfere in vetro soffiato. Le cinque dimensioni e le sette diverse finiture disponibili offrono ampia libertà di arredamento, sia come punti luce sospesi singolarmente che in leggere e vivaci composizioni multiple su cluster. La finitura bianca satinata resistente alle impronte digitali cambia magicamente la percezione della sfera e del suo volume, aprendo nuove opportunità per la decorazione d'interni, mentre la nuova finitura Glossy Bronze è sinonimo di bellezza affascinante, ispira stabilità e infonde calma a qualsiasi ambiente abitativo.

Cluster suspension lamp

Random Solo 28, 23 and 18,
FINISHES Frosted White, Glossy
Smoke and Clear

Random Solo, *design by Chia-Ying Lee, 2020*





Random Solo, composition on round canopies and single lights on single canopies, FINISHES Chrome and Clear



Random Solo 12, 14, 18, 23 and 28, FINISHES Clear and Glossy Smoke

Random Solo 23 and 28,
composition of 14 lights on a *round canopy*,
FINISHES Clear and Glossy Smoke



Random Solo, composition of 9 lights on a *round canopy*, FINISHES Glossy Bronze, Glossy Smoke and Clear

Random Solo, *recessed micro canopy*, FINISHES Glossy Bronze, Glossy Smoke and Clear



Random Solo, composition of 14 lights on a
round canopy, FINISHES Glossy Bronze and Clear



Random Solo 12, 14, 18, 23 and 28, *recessed micro canopies*, FINISHES Frosted White, Gold and Clear



Random Solo 28 and 23, FINISHES Clear and Rose Gold

Random Solo 14, 23 and 28,
composition of 5 lights on a *round canopy*
and single lights on *single mini canopies*,
FINISHES Clear and Rose Gold



1



2

1–Random Solo, FINISH Frosted White
2–Random Solo, FINISHES Glossy
Smoke and Clear

Random Solo 23, composition of 4 lights
on a *long track*, FINISH Frosted White





Random Solo 28, 23 and 18, FINISHES Glossy Bronze and Clear

Random Solo Cinq sphères parfaites fluctuant dans l'air comme de suaves bulles de verre. Random Solo revisite le concept de la suspension Random en séparant le cluster original de trois pièces et en ajoutant deux nouvelles sphères en verre soufflé. Les cinq tailles et les sept finitions différentes désormais disponibles permettent une grande liberté de style, tant comme points lumineux suspendus individuellement qu'en combinaisons légères et animées sur des clusters. La finition blanche givrée résistante aux traces de doigts change comme par magie la perception de la sphère et de son volume, permettant de nouvelles opportunités pour la décoration d'intérieur, alors que la nouvelle finition Glossy Bronze évoque la beauté séduisante et la stabilité, pour insuffler de la douceur à tous les espaces de vie. ●FR

Random Solo Fünf perfekte Kugeln, die wie leichte Glasblasen in der Luft schweben. Random Solo überarbeitet das Konzept der Hängeleuchte Random, für das das originelle Cluster mit drei Elementen aufgeteilt wurde, um zwei neue Kugeln aus mundgeblasenem Glas hinzuzufügen. Die fünf Größen und sieben verschiedenen Ausführungen bieten große Gestaltungsfreiheit, sowohl als einzeln aufgehängte Lichtpunkte als auch in leichten und lebhaften Kombinationen auf Clustern. Die gegen Fingerabdrücke resistente satinierte weiße Ausführung verändert auf magische Weise die Wahrnehmung der Kugel und ihres Volumens und eröffnet neue Möglichkeiten für die Innenraumgestaltung, während die neue Ausführung Glossy Bronze ein Synonym für verführerische Schönheit ist, die Stabilität vermittelt und Ruhe in jede Wohnumgebung einfließen lässt. ●DE

Las cinco perfectas esferas de la lámpara Random Solo flotan en el aire como delicadas burbujas de vidrio. Random Solo revisa el concepto de la lámpara colgante Random mediante una división del grupo de lámparas colgantes original y el añadido de dos nuevas esferas de vidrio soplado. Los cinco tamaños y los siete acabados distintos disponibles ofrecen una amplia libertad de diseño, tanto como puntos de luz colgantes individuales como en combinaciones ligeras y animadas en grupos de lámparas colgantes. El característico y resistente acabado blanco escarchado cambia mágicamente la percepción de la esfera y su volumen y da pie a nuevas oportunidades para la decoración de interiores, mientras que el nuevo acabado en bronce brillante es sinónimo de una belleza seductora que inspira estabilidad e infunde calma a cualquier entorno habitable. ●ES

Random Solo Пять идеальных сфер, парящих в воздухе подобно нежным стеклянным пузырям. Random Solo по-новому осмысливает концепцию подвесного светильника Random, разделив оригинальный кластер, состоящий из трех частей, и добавляя к нему две новые сферы из дутого стекла. Пять размеров и семь имеющихся различных отделок предлагают огромную свободу по оформлению декора, как в качестве индивидуально подвешенных световых точек, так и в легких и ярких комбинациях в кластерах. Морозно-белая отделка, устойчивая к следам от пальцев, магически изменяет восприятие сферы и ее объема, открывая новые возможности для оформления интерьера, а новая отделка Glossy Bronze является синонимом манящей красоты, вдохновляя стабильность и вселяя спокойствие в любое помещение для жизни. ●RU

Random Solo 那五个完美的球体就像柔和的玻璃泡泡一般漂浮于空中。Random Solo重新审视了Random悬吊灯的理念,将最初的三件式底盘分开而来并添加了两个新的吹制玻璃球体。五种尺寸和七种不同饰面提供了充足的造型自由度,既可作为单独悬吊的照明点,亦可作为轻盈活泼的底盘组合。耐指纹的磨砂白色饰面神奇地改变了球体及其体积的感觉,为室内装饰开辟了崭新机遇,而全新的亮光青铜饰面则是迷人之美的代名词,可为任何生活环境注入稳定平和的感觉。●ZH

Visit website:



Random Solo 12 » Cluster suspension lamp

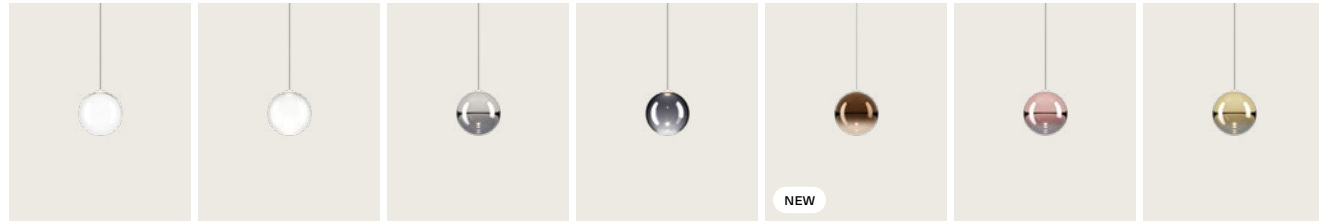

Random Solo 14 » Cluster suspension lamp

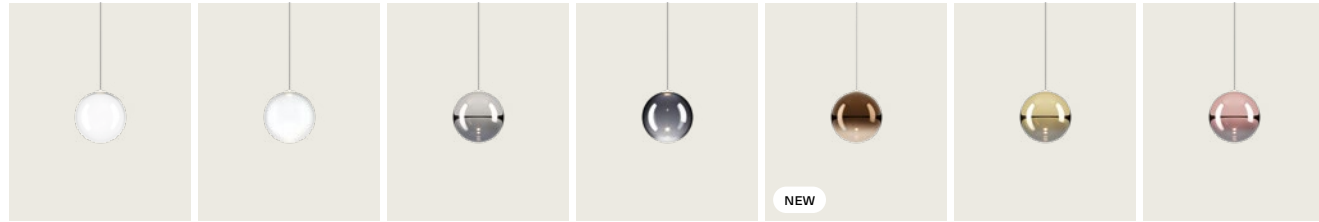

Random Solo 18 » Cluster suspension lamp

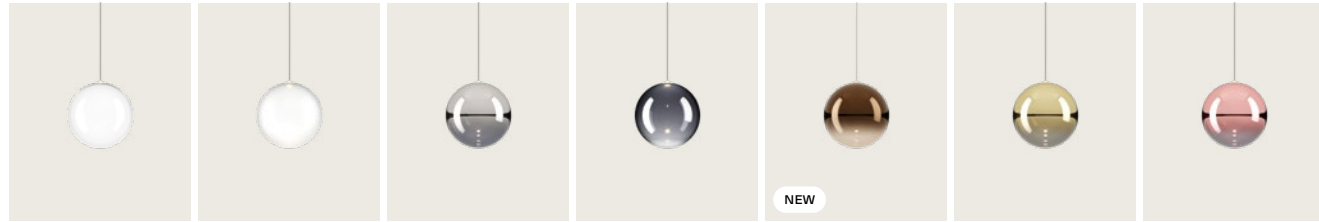

Random Solo 23 » Cluster suspension lamp

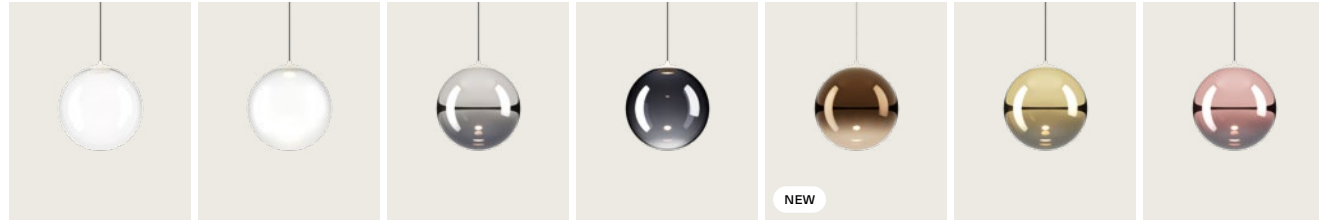

Random Solo 28 » Cluster suspension lamp

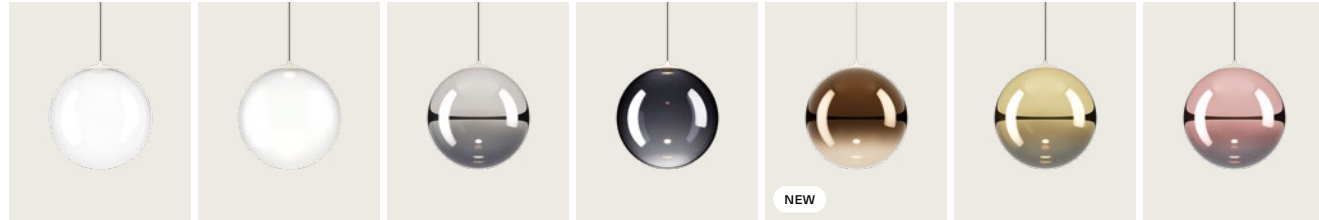

Finishes » Gradient effect

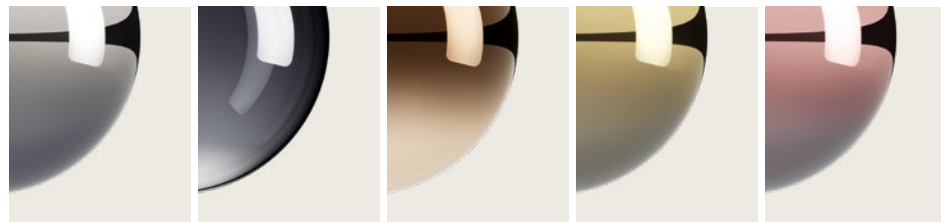

Random Solo, design by Chia-Ying Lee, 2020

Cluster suspension lamp

Random Solo 12

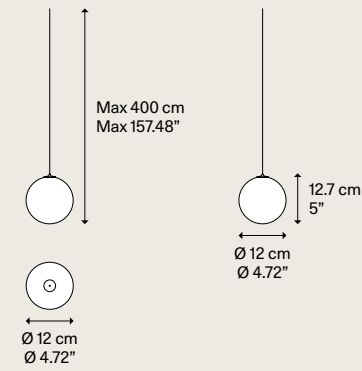

Light source
Sorgente luminosa

LED
» 2700 K
» 1 W / 150 lm
» 350 mA
» CRI 90
» MacAdam 3-Step

LED
» 3000 K
» 1 W / 160 lm
» 350 mA
» CRI 90
» MacAdam 3-Step

LED and driver included
LED e driver inclusi

Blown glass diffuser
Diffusore in vetro soffiato

Clear
Trasparente

Frosted White
Bianco Satinato

Chrome
Cromo

Glossy Smoke
Fumo Lucido

Glossy Bronze ^{NEW}
Bronzo Lucido

Gold
Oro

Rose Gold
Oro Rosa

Clear
Trasparente

Frosted White
Bianco Satinato

Chrome
Cromo

Glossy Smoke
Fumo Lucido

Glossy Bronze ^{NEW}
Bronzo Lucido

Gold
Oro

Rose Gold
Oro Rosa

Code
Codice

17111 0027

17111 1327

17111 4027

17111 4327

17111 4627

17111 5027

17111 5527

17111 0030

17111 1330

17111 4030

17111 4330

17111 4630

17111 5030

17111 5530

or

Net weight / Peso netto: 0.25 kg

Pack / Colli: 2

Energy class / Classe energetica: D

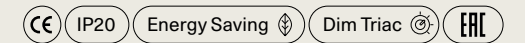

Suspension lamps must be installed on a canopy ► pag. 432-441
Le lampade a sospensione devono essere installate su rosone ► pag. 432-441

Ecodesign regulation ► pag. 444-445
Regolamento di Ecodesign ► pag. 444-445

Random Solo, design by Chia-Ying Lee, 2020

Cluster suspension lamp

Random Solo 14

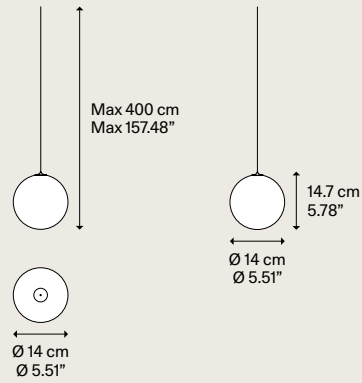

Light source Sorgente luminosa	Blown glass diffuser Diffusore in vetro soffiato	Code Codice
LED ↘ 2700 K ↘ 1 W/150 lm ↘ 350 mA ↘ CRI 90 ↘ MacAdam 3-Step	Clear Trasparente	17112 0027
	Frosted White Bianco Satinato	17112 1327
	Chrome Cromo	17112 4027
	Glossy Smoke Fumo Lucido	17112 4327
	Glossy Bronze ^{NEW} Bronzo Lucido	17112 4627
	Gold Oro	17112 5027
	Rose Gold Oro Rosa	17112 5527
	or	
	Clear Trasparente	17112 0030
	Frosted White Bianco Satinato	17112 1330
LED ↘ 3000 K ↘ 1 W/160 lm ↘ 350 mA ↘ CRI 90 ↘ MacAdam 3-Step	Chrome Cromo	17112 4030
	Glossy Smoke Fumo Lucido	17112 4330
	Glossy Bronze ^{NEW} Bronzo Lucido	17112 4630
	Gold Oro	17112 5030
	Rose Gold Oro Rosa	17112 5530
	LED and driver included LED e driver inclusi	

Net weight/Peso netto: 0.32 kg Pack/Coll: 2 Energy class/Classe energetica: D

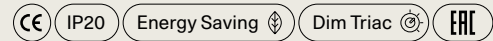

Suspension lamps must be installed on a canopy ▶ pag. 432-441
Le lampade a sospensione devono essere installate su rosone ▶ pag. 432-441

Ecodesign regulation ▶ pag. 444-445
Regolamento di Ecodesign ▶ pag. 444-445

Random Solo, design by Chia-Ying Lee, 2020

Cluster suspension lamp

Random Solo 18

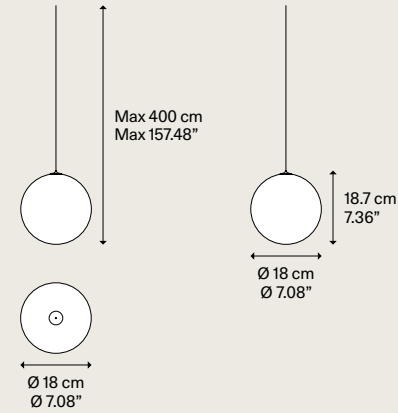

Light source Sorgente luminosa	Blown glass diffuser Diffusore in vetro soffiato	Code Codice
LED ↘ 2700 K ↘ 1 W/150 lm ↘ 350 mA ↘ CRI 90 ↘ MacAdam 3-Step	Clear Trasparente	17113 0027
	Frosted White Bianco Satinato	17113 1327
	Chrome Cromo	17113 4027
	Glossy Smoke Fumo Lucido	17113 4327
	Glossy Bronze ^{NEW} Bronzo Lucido	17113 4627
	Gold Oro	17113 5027
	Rose Gold Oro Rosa	17113 5527
	or	
	Clear Trasparente	17113 0030
	Frosted White Bianco Satinato	17113 1330
LED ↘ 3000 K ↘ 1 W/160 lm ↘ 350 mA ↘ CRI 90 ↘ MacAdam 3-Step	Chrome Cromo	17113 4030
	Glossy Smoke Fumo Lucido	17113 4330
	Glossy Bronze ^{NEW} Bronzo Lucido	17113 4630
	Gold Oro	17113 5030
	Rose Gold Oro Rosa	17113 5530
	LED and driver included LED e driver inclusi	

Net weight/Peso netto: 0.8 kg Pack/Coll: 2 Energy class/Classe energetica: D

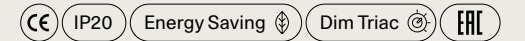

Suspension lamps must be installed on a canopy ▶ pag. 432-441
Le lampade a sospensione devono essere installate su rosone ▶ pag. 432-441

Ecodesign regulation ▶ pag. 444-445
Regolamento di Ecodesign ▶ pag. 444-445

Random Solo, design by Chia-Ying Lee, 2020

Cluster suspension lamp

Random Solo 23

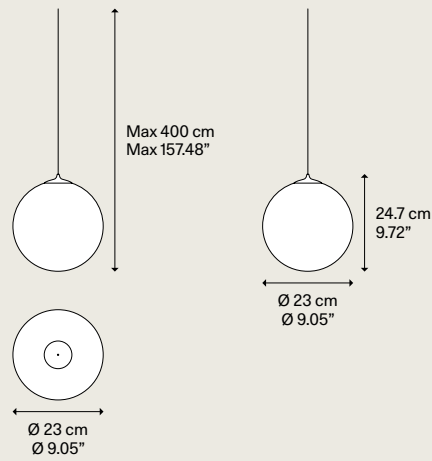

Light source
Sorgente luminosa

LED
 ↘ 2700 K
 ↘ 3 W/450 lm
 ↘ 350 mA
 ↘ CRI 90
 ↘ MacAdam 3-Step

LED
 ↘ 3000 K
 ↘ 3 W/480 lm
 ↘ 350 mA
 ↘ CRI 90
 ↘ MacAdam 3-Step

LED and driver included
LED e driver inclusi

Blown glass diffuser
Diffusore in vetro soffiato

Clear Trasparente	17114 0027
Frosted White Bianco Satinato	17114 1327
Chrome Cromo	17114 4027
Glossy Smoke Fumo Lucido	17114 4327
Glossy Bronze ^{NEW} Bronzo Lucido	17114 4627
Gold Oro	17114 5027
Rose Gold Oro Rosa	17114 5527
or	
Clear Trasparente	17114 0030
Frosted White Bianco Satinato	17114 1330
Chrome Cromo	17114 4030
Glossy Smoke Fumo Lucido	17114 4330
Glossy Bronze ^{NEW} Bronzo Lucido	17114 4630
Gold Oro	17114 5030
Rose Gold Oro Rosa	17114 5530

Net weight/Peso netto: 1.1 kg Pack/Colli: 2 Energy class/Classe energetica: D

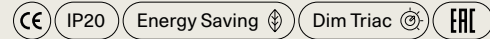

Suspension lamps must be installed on a canopy ▶ pag. 432-441
Le lampade a sospensione devono essere installate su rosone ▶ pag. 432-441

Ecodesign regulation ▶ pag. 444-445
Regolamento di Ecodesign ▶ pag. 444-445

Random Solo, design by Chia-Ying Lee, 2020

Cluster suspension lamp

Random Solo 28

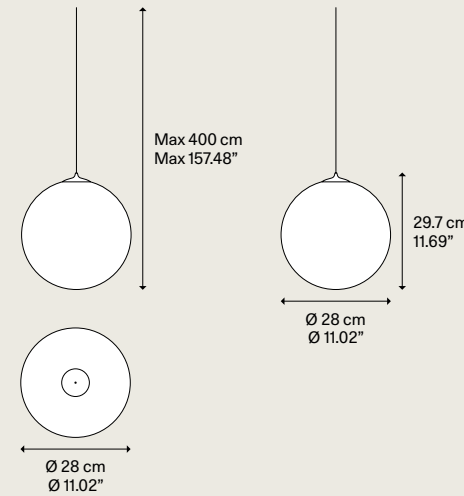

Light source
Sorgente luminosa

LED
 ↘ 2700 K
 ↘ 3 W/450 lm
 ↘ 350 mA
 ↘ CRI 90
 ↘ MacAdam 3-Step

LED
 ↘ 3000 K
 ↘ 3 W/480 lm
 ↘ 350 mA
 ↘ CRI 90
 ↘ MacAdam 3-Step

LED and driver included
LED e driver inclusi

Blown glass diffuser
Diffusore in vetro soffiato

Clear Trasparente	17115 0027
Frosted White Bianco Satinato	17115 1327
Chrome Cromo	17115 4027
Glossy Smoke Fumo Lucido	17115 4327
Glossy Bronze ^{NEW} Bronzo Lucido	17115 4627
Gold Oro	17115 5027
Rose Gold Oro Rosa	17115 5527
or	
Clear Trasparente	17115 0030
Frosted White Bianco Satinato	17115 1330
Chrome Cromo	17115 4030
Glossy Smoke Fumo Lucido	17115 4330
Glossy Bronze ^{NEW} Bronzo Lucido	17115 4630
Gold Oro	17115 5030
Rose Gold Oro Rosa	17115 5530

Net weight/Peso netto: 1.8 kg Pack/Colli: 2 Energy class/Classe energetica: D

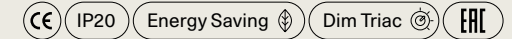

Suspension lamps must be installed on a canopy ▶ pag. 432-441
Le lampade a sospensione devono essere installate su rosone ▶ pag. 432-441

Ecodesign regulation ▶ pag. 444-445
Regolamento di Ecodesign ▶ pag. 444-445

Example of composition

7 Lights Rectangular

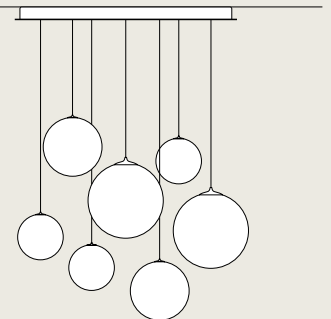
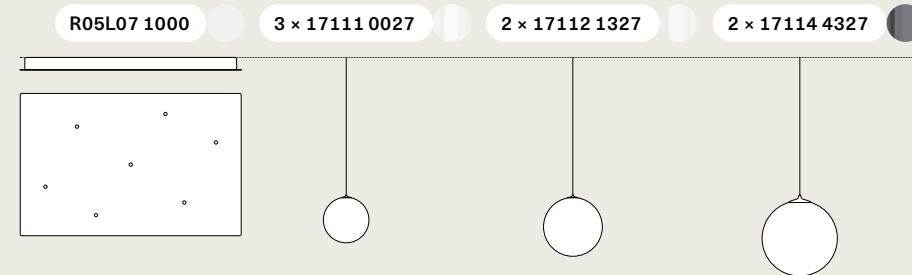

Jefferson

The Jefferson suspension lamp designed by Luca Nichetto is reminiscent of music and iconic images in psychedelic works of art from the 1960s. The vortex motif decorating the diffuser is embellished by the timeless classicism of Bohemian crystal, which diffuses evocative atmospheres of light. Dynamic in its many sizes and multiple compositions, Jefferson's elegance keeps up with the excellent performance of LED interior lighting.

La lampada a sospensione Jefferson disegnata da Luca Nichetto rimanda alla musica e alle immagini iconiche in opere d'arte psichedeliche degli anni Sessanta. Il motivo a vortice che decora il diffusore è impreziosito dalla classicità senza tempo del cristallo di Boemia, che diffonde suggestive atmosfere di luce. Dinamica nelle diverse dimensioni e in composizioni multiple, l'eleganza di Jefferson non rinuncia alle eccellenti prestazioni della luce interna a LED.

Cluster suspension lamp

Jefferson small, medium and mini,
FINISH Clear + Gold

Jefferson, *design by* Luca Nichetto, 2019





Jefferson mini, composition
of 30 lights on a *round canopy*,
FINISH Clear + Black Chrome



Jefferson mini, small and medium,
special composition of 68 lights,
FINISH Clear + Gold





Jefferson mini, FINISH Clear + Black Chrome

Jefferson mini, small and medium,
composition of 5 lights on a
round canopy, FINISH Clear + Gold

La lampe à suspension Jefferson dessinée par Luca Nichetto fait référence à la musique et aux images emblématiques des œuvres d'art psychédélics des années soixante. Le motif vortex qui orne le diffuseur est rehaussé par le classicisme intemporel du cristal de Bohême, qui diffuse des atmosphères de lumière suggestives. Dynamique dans différentes tailles et dans de multiples compositions, l'élégance de Jefferson ne renonce pas aux excellentes performances de l'éclairage intérieur LED. ● FR

Die von Luca Nichetto entworfene Hängeleuchte „Jefferson“ erinnert an die Musik und die ikonischen Darstellungen in psychedelischen Kunstwerken der sechziger Jahre. Die Wirbel-Optik des Diffusors wird aufgewertet durch den klassisch-zeitlosen Stil des böhmischen Kristalls, das suggestive Lichtstimmungen erzeugt. Erhältlich in verschiedenen Größen und vielfältigen Kompositionen, verzichtet die Eleganz von Jefferson nicht auf die hervorragende Leistung der LED-Innenbeleuchtung. ● DE

La lámpara colgante Jefferson diseñada por Luca Nichetto hace referencia a la música y a las imágenes icónicas en obras de arte psicodélicas de los años sesenta. El motivo en espiral que decora el difusor está embellecido por el estilo clásico sin tiempo del cristal de Bohemia, que difunde atmósferas sugestivas de luz. Dinámica en los diferentes tamaños y en composiciones múltiples, la elegancia de Jefferson no renuncia a las excelentes prestaciones de la luz interna de LED. ● ES

Подвесной светильник Jefferson, дизайн Лука Никетто, вызывает в памяти музыку и культовые изображения на психоделических произведениях шестидесятых годов. Ценность вихревому украшению диффузора придает вечная классика богемского хрустала, благодаря которому создается необыкновенная световая атмосфера. Элегантная и динамичная за счет различных размеров и множественных комбинаций модель Jefferson не отказывается от превосходных характеристик внутреннего светодиодного освещения. ● RU

Luca Nichetto受上世纪六十年代迷幻视觉艺术的音乐和图案的启发设计了吊灯Jefferson。灯罩上装饰的漩涡图案因波西米亚水晶的永恒古典主义更显精美珍贵，将迷人的光线散发开来。Jefferson吊灯具有不同尺寸和多种组成的动态变化，精美雅致的同时更良好利用了内置LED灯的优秀性能。● ZH

Visit website:



Jefferson mini » Cluster suspension lamp



Jefferson small » Cluster suspension lamp



Jefferson medium » Cluster suspension lamp



Jefferson, design by Luca Nichetto, 2019

Cluster suspension lamp

Jefferson mini

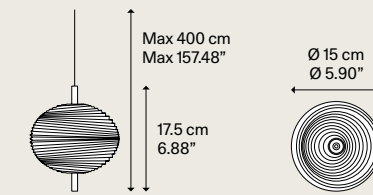

Light source
Sorgente luminosa

LED
 » 2700 K
 » 3 W/450 lm
 » 350 mA
 » CRI 90
 » MacAdam 3-Step

Metal structure
Montatura in metallo

● Black Chrome
Cromo Nero

● Gold
Oro

Bohemian crystal diffuser
Diffusore in cristallo di Boemia

● Clear
Trasparente

● Clear
Trasparente

Code
Codice

16821 4227

16821 5027

LED and driver included
LED e driver inclusi

Net weight/Peso netto: 1.40 kg

Pack/Colli: 1

Energy class/Classe energetica: D

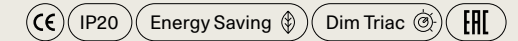

Jefferson small

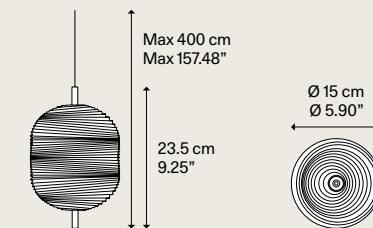

Light source
Sorgente luminosa

LED
 » 2700 K
 » 3 W/450 lm
 » 350 mA
 » CRI 90
 » MacAdam 3-Step

● Black Chrome
Cromo Nero

● Gold
Oro

● Clear
Trasparente

● Clear
Trasparente

16822 4227

16822 5027

LED and driver included
LED e driver inclusi

Net weight/Peso netto: 2.10 kg

Pack/Colli: 1

Energy class/Classe energetica: D

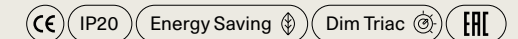

Jefferson medium

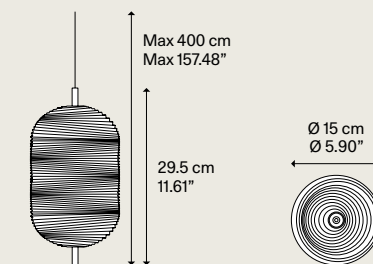

Light source
Sorgente luminosa

LED
 » 2700 K
 » 3 W/450 lm
 » 350 mA
 » CRI 90
 » MacAdam 3-Step

● Black Chrome
Cromo Nero

● Gold
Oro

● Clear
Trasparente

● Clear
Trasparente

16823 4227

16823 5027

LED and driver included
LED e driver inclusi

Net weight/Peso netto: 2.80 kg

Pack/Colli: 1

Energy class/Classe energetica: D

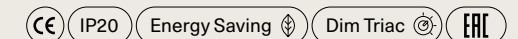

Suspension lamps must be installed on a canopy ► pag. 432-441
Le lampade a sospensione devono essere installate su rosone ► pag. 432-441

Ecodesign regulation ► pag. 444-445
Regolamento di Ecodesign ► pag. 444-445

Nostalgia

Nostalgia with its retro flair, Nostalgia elegantly tells of ancient glass blowing practices in three sinuous forms that can be combined at will. The perfection of the glass, the innovative LED technology and six elegant finishes make Nostalgia an extremely modern and versatile lamp that lends itself to the creation of captivating atmospheres, whether on or off. Now also available in a new version with black frame and cable for all finishes, this additional combination further expands the possibilities to personalize any living spaces: on its own to illuminate a table or to add a sophisticated touch to a bedroom, in linear groups above a counter or peninsula, or in cluster compositions to emphasise larger spaces with refined scenic effects.

Con il suo sapore retrò, Nostalgia racconta con eleganza antiche storie di vetro soffiato in tre forme sinuose che possono essere combinate a piacere. La perfezione del vetro, l'innovativa tecnologia LED e le sei raffinate finiture fanno di Nostalgia una lampada estremamente contemporanea e versatile che permette di creare atmosfere affascinanti sia da accesa che da spenta. Ora disponibile anche nella nuova versione con montatura e cavo nero per tutte le finiture, tale combinazione aggiuntiva amplia ulteriormente le possibilità di personalizzazione degli spazi abitativi: da sola per illuminare un tavolo o per conferire un tocco sofisticato alla stanza da letto, in gruppi lineari sopra un bancone o una penisola, oppure in composizioni su cluster per dare risalto a spazi più ampi con raffinati effetti scenografici.

Cluster suspension lamp

Nostalgia medium, large and small,
FINISH Glossy Bronze

Nostalgia, *design by* Dima Loginoff, 2015





Nostalgia small, medium and large, special composition of 82 lights on *recessed micro canopies*

FINISHES Clear, Chrome and Gold



Nostalgia small on a *wall canopy*, FINISH Chrome, black cable and black structure version

Nostalgia medium and small,
FINISHES Rose Gold and Clear, black
cable and black structure version



Nostalgia small, medium and large, composition of 14 lights on a *rectangular canopy*

FINISHES Clear, Glossy Bronze and Glossy Smoke



Nostalgia small, medium and large, composition of 24 lights on a round canopy, FINISHES Clear and Glossy Smoke

Avec son côté rétro, Nostalgia raconte avec élégance les pratiques anciennes du soufflage du verre sous trois formes sinueuses à combiner à volonté. La perfection du verre, la technologie LED innovante et six finitions élégantes font de Nostalgia une lampe extrêmement moderne et polyvalente qui se prête à la création d'atmosphères captivantes, qu'elle soit allumée ou éteinte. Désormais disponible dans une nouvelle version avec monture et câble noirs pour toutes les finitions, cette combinaison supplémentaire augmente les possibilités de personnalisation de tous les espaces de vie : seule, pour éclairer une table ou ajouter une touche sophistiquée à une chambre, en groupes linéaires au-dessus d'un comptoir ou d'un îlot, ou dans des compositions en cluster pour mettre en exergue des espaces plus grands avec des effets scéniques raffinés. ● FR

Mit ihrem Retro-Flair, erzählt Nostalgia auf elegante Weise von alten Glasbläsertechniken in drei gewundenen Formen, die beliebig kombiniert werden können. Die Perfektion des Glases, die innovative LED-Technologie und die sechs eleganten Ausführungen machen Nostalgia zu einer äußerst modernen und vielseitigen Leuchte, mit der sich sowohl im eingeschalteten als auch im ausgeschalteten Zustand fesselnde Stimmungen erzeugen lassen. Jetzt auch in einer neuen Version mit schwarzem Gestell und Kabel für alle Ausführungen erhältlich, bietet diese zusätzliche Kombination noch mehr Möglichkeiten zur individuellen Gestaltung von Wohnräumen: einzeln zur Beleuchtung eines Tisches oder als raffinierter Akzent in einem Schlafzimmer, in linearen Gruppen über einer Theke oder Halbinsel oder in Cluster-Kompositionen, um größere Räume mit raffinierten szenischen Effekten zu betonen. ● DE

Con su estilo retro, la lámpara Nostalgia nos habla de las antiguas prácticas de soplado de vidrio con tres formas sinuosas que pueden combinarse según se desee. La perfección del vidrio, la innovadora tecnología LED y sus seis elegantes acabados hacen de Nostalgia una lámpara extremadamente moderna y versátil que se presta para la creación de atmósferas cautivadoras, tanto encendida como apagada. Ahora también disponible en una nueva versión con estructura y cables de color negro para todos los acabados, esta combinación adicional amplía aún más las posibilidades de personalizar cualquier espacio habitable: por sí sola para iluminar una mesa o aportar un toque de sofisticación a un dormitorio, en grupos lineales encima de una barra o una isleta, o en grupos de lámparas colgantes para hacer destacar espacios mayores con refinados efectos escénicos. ● ES

Nostalgia с ее ретро-стилем элегантно повествует о древнем искусстве выдувания стекла, отраженном в трех извилистых формах, которые можно сочетать по желанию. Совершенство стекла, инновационная светодиодная технология и шесть элегантных вариантов отделки делают Nostalgia современным и универсальным светильником, создающим волшебную атмосферу как во включенном, так и в выключенном состоянии. Эта дополнительная комбинация, доступная также в новой версии с черной рамой и кабелем для всех видов отделки, расширяет возможности индивидуального оформления любых жилых помещений: она может использоваться для освещения стола или вносить изысканный штрих в спальню, применяться в линейных группах над кухонной стойкой или полуостровом, или в кластерных композициях, подчеркивающих большие пространства изысканными сценическими эффектами. ● RU

以其怀旧复古的格调, Nostalgia用三种可随意组合的蜿蜒形状优雅地讲述了古老玻璃吹制的实践方式。玻璃的完美、LED技术的创新和六种优雅饰面使 Nostalgia成为一款极为现代且功能多用的灯品,无论点亮时还是关闭时都有助于迷人氛围的营造。现还提供一份全新版本,带有黑色框架和适用于所有饰面的线缆,这种附加组合进一步扩展了将任何生活空间做到个性化的可能性:它可单独照亮桌子或为卧室凭添一份精致润色,通过位于吧台或半岛上方的流线型组合或通过底盘组合彰显具有精致场景效果的更大空间。● ZH

Visit website:



Nostalgia small » Cluster suspension lamp

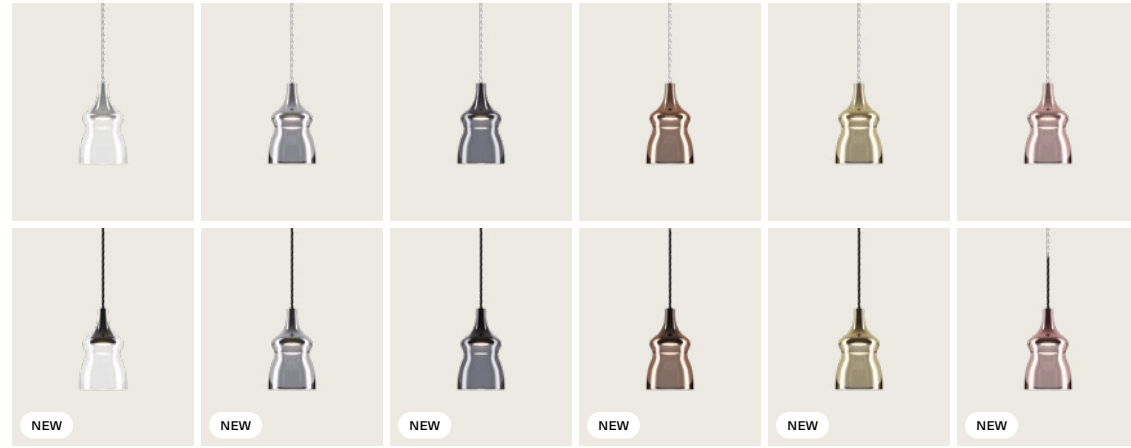

Nostalgia medium » Cluster suspension lamp

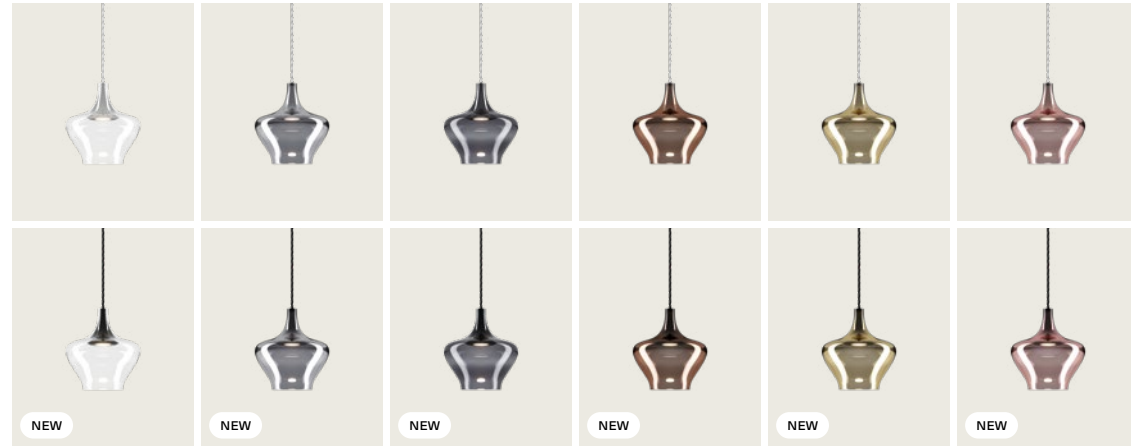

Nostalgia large » Cluster suspension lamp

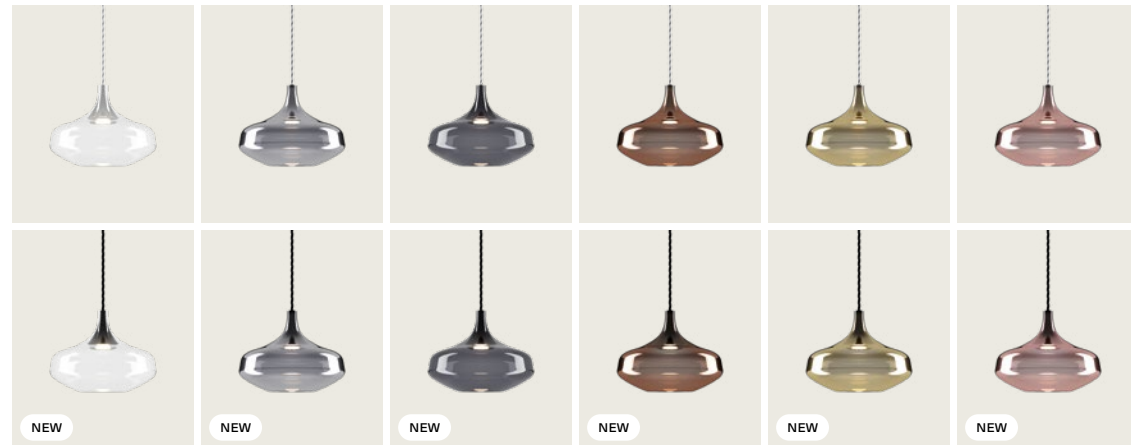

Transparent cable and chrome structure



Black cable and black structure



Nostalgia, design by Dima Loginoff, 2015

Cluster suspension lamp

Nostalgia small

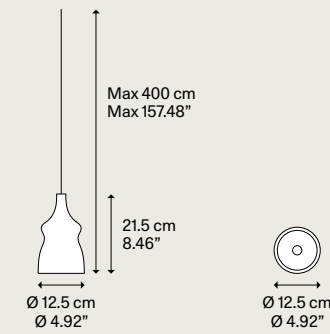

Light source
Sorgente luminosa

LED
» 2700 K
» 7 W / 1280 lm
» 350 mA
» CRI 90
» MacAdam 3-Step

Metal structure
Montatura in metallo

Chrome
Cromo

Transparent cable
Cavo Trasparente

Matte Black - 9005 NEW
Nero Opaco - 9005

Black cable
Cavo Nero

LED and driver included
LED e driver inclusi

Blown glass diffuser
Diffusore in vetro soffiato

Blown glass diffuser Diffusore in vetro soffiato	Code Codice
Clear Trasparente	15412 0027
Chrome Cromo	15412 4027
Glossy Smoke Fumo Lucido	15412 4327
Glossy Bronze Bronzo Lucido	15412 4627
Gold Oro	15412 5027
Rose Gold Oro Rosa	15412 5527
Clear Trasparente	15415 0027
Chrome Cromo	15415 4027
Glossy Smoke Fumo Lucido	15415 4327
Glossy Bronze Bronzo Lucido	15415 4627
Gold Oro	15415 5027
Rose Gold Oro Rosa	15415 5527

Net weight/Peso netto: 0.66 kg

Pack/Collì: 2

Energy class/Classe energetica: C

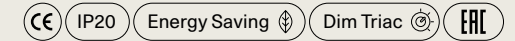

Suspension lamps must be installed on a canopy » pag. 432-441
Le lampade a sospensione devono essere installate su rosone » pag. 432-441

Ecodesign regulation » pag. 444-445
Regolamento di Ecodesign » pag. 444-445

Nostalgia, design by Dima Loginoff, 2015

Cluster suspension lamp

Nostalgia medium

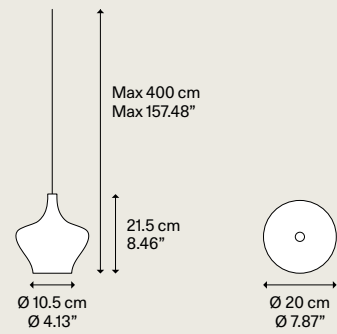

Light source Sorgente luminosa	Metal structure Montatura in metallo	Blown glass diffuser Diffusore in vetro soffiato	Code Codice
LED ↘ 2700 K ↘ 7 W / 1280 lm ↘ 350 mA ↘ CRI 90 ↘ MacAdam 3-Step	Chrome Cromo	Clear Trasparente	15413 0027
		Chrome Cromo	15413 4027
		Glossy Smoke Fumo Lucido	15413 4327
		Glossy Bronze Bronzo Lucido	15413 4627
		Gold Oro	15413 5027
		Rose Gold Oro Rosa	15413 5527
	Matte Black - 9005 ^{NEW} Nero Opaco - 9005	Clear Trasparente	15416 0027
		Chrome Cromo	15416 4027
		Glossy Smoke Fumo Lucido	15416 4327
		Glossy Bronze Bronzo Lucido	15416 4627
		Gold Oro	15416 5027
		Rose Gold Oro Rosa	15416 5527
Transparent cable Cavo Trasparente			
Black cable Cavo Nero			

LED and driver included
LED e driver inclusi

Net weight/Peso netto: 0.75 kg Pack/Colli: 2 Energy class/Classe energetica: C

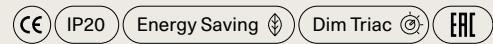

Suspension lamps must be installed on a canopy ▶ pag. 432-441
Le lampade a sospensione devono essere installate su rosone ▶ pag. 432-441

Ecodesign regulation ▶ pag. 444-445
Regolamento di Ecodesign ▶ pag. 444-445

Nostalgia, design by Dima Loginoff, 2015

Cluster suspension lamp

Nostalgia large

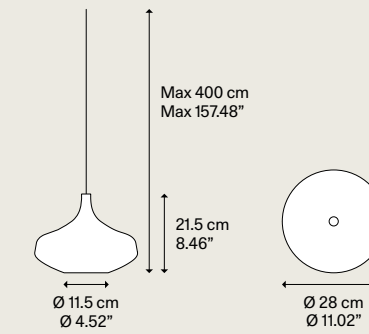

Light source Sorgente luminosa	Metal structure Montatura in metallo	Blown glass diffuser Diffusore in vetro soffiato	Code Codice
LED ↘ 2700 K ↘ 7 W / 1280 lm ↘ 350 mA ↘ CRI 90 ↘ MacAdam 3-Step	Chrome Cromo	Clear Trasparente	15414 0027
		Chrome Cromo	15414 4027
		Glossy Smoke Fumo Lucido	15414 4327
		Glossy Bronze Bronzo Lucido	15414 4627
		Gold Oro	15414 5027
		Rose Gold Oro Rosa	15414 5527
	Matte Black - 9005 ^{NEW} Nero Opaco - 9005	Clear Trasparente	15417 0027
		Chrome Cromo	15417 4027
		Glossy Smoke Fumo Lucido	15417 4327
		Glossy Bronze Bronzo Lucido	15417 4627
		Gold Oro	15417 5027
		Rose Gold Oro Rosa	15417 5527
Transparent cable Cavo Trasparente			
Black cable Cavo Nero			

LED and driver included
LED e driver inclusi

Net weight/Peso netto: 1.02 kg Pack/Colli: 2 Energy class/Classe energetica: C

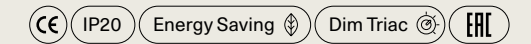

Suspension lamps must be installed on a canopy ▶ pag. 432-441
Le lampade a sospensione devono essere installate su rosone ▶ pag. 432-441

Ecodesign regulation ▶ pag. 444-445
Regolamento di Ecodesign ▶ pag. 444-445

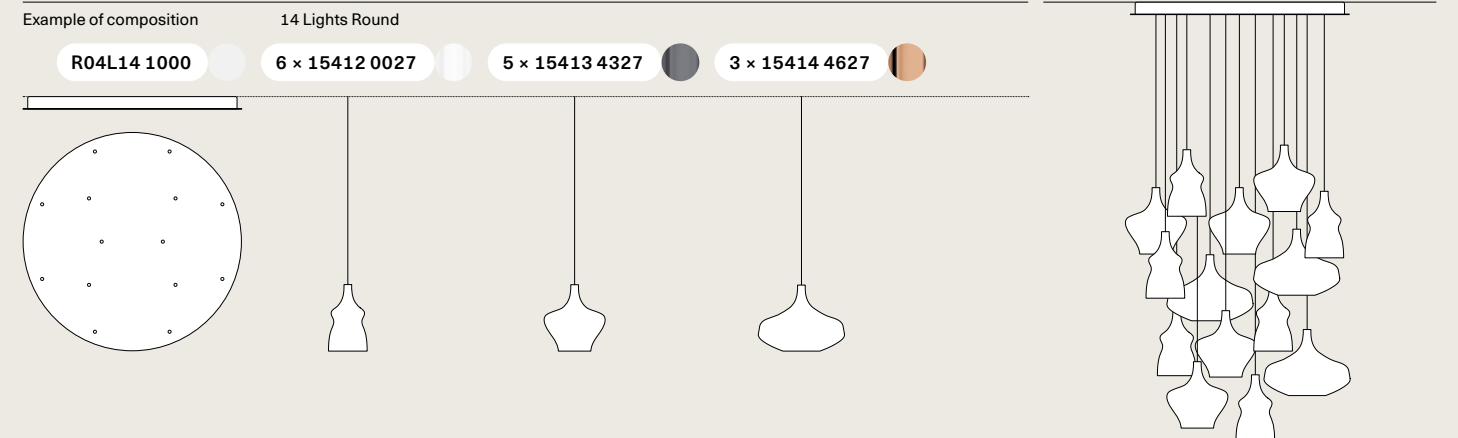

Sky-Fall

In Sky-Fall, the traditional glass processing techniques embrace the most advanced LED technologies. The shape of Sky-Fall captures the imagination in its reminiscence of ancient decanters in precious blown glass. Its function amazes thanks to the innovative double LED source that diffuses direct and indirect light. Available in two sizes and in five finishes, and now also in a 3000 K light colour temperature version, Sky-Fall decorates both when it is on and when it is off.

In Sky-Fall le tradizionali tecniche di lavorazione del vetro abbracciano le tecnologie LED più avanzate. La forma di Sky-Fall emoziona ricordando antichi decanter in prezioso vetro soffiato. La sua funzione stupisce grazie all'innovativa doppia sorgente a LED che diffonde luce diretta e indiretta. Disponibile in due dimensioni e in cinque finiture, e ora anche nella versione con temperatura colore a 3000 K, Sky-Fall arreda sia da accesa che da spenta.

Suspension lamp

Sky-Fall large and medium,
FINISH Glossy Smoke

Sky-Fall, *design by* Studio Italia Design, 2014





Sky-Fall medium,
FINISH Rose Gold



Sky-Fall large and medium, FINISH Clear



Sky-Fall, FINISH Clear

Sky-Fall large and medium,
FINISH Glossy Smoke





Sky-Fall medium on Sky-Fall double canopy, FINISH Clear



Sky-Fall medium and large, FINISH Glossy Bronze

Chez Sky-Fall, les techniques traditionnelles d'ennoblissement du verre intègrent les technologies LED les plus avant-gardistes. La forme de Sky-Fall séduit car elle évoque d'anciens décanteurs en verre soufflé précieux. La double source LED innovante diffuse une lumière tant directe qu'indirecte, ce qui rend son fonctionnement pour le moins surprenant. Disponible en deux tailles et cinq finitions, désormais même dans la version température de couleur 3000 K, allumée ou éteinte, Sky-Fall devient un complément d'ameublement décoratif. ●FR

Bei Sky-Fall treffen traditionelle Glasverarbeitungstechniken auf fortschrittlichste LED-Technologien. Die Form von Sky-Fall begeistert und erinnert an alte Dekanter aus hochwertigem, geblasenem Glas. Die Funktion der Lampe beeindruckt dank der innovativen, doppelten LED-Lichtquelle, die gleichzeitig für direkte und indirekte Beleuchtung sorgt. In zwei Größen und mit fünf Oberflächen verfügbar, jetzt auch in der Ausführung mit Farbtemperatur 3000 K, ist Sky-Fall sowohl ein- wie auch ausgeschaltet ein schöner Einrichtungsgegenstand. ●DE

En Sky-Fall las tradicionales técnicas de elaboración del vidrio abrazan las tecnologías LED más avanzadas. La forma de Sky-Fall emociona recordando antiguos decantadores en precioso vidrio soplado. Su función impacta gracias a la innovadora doble fuente de LED que difunde luz directa e indirecta. Disponible en dos dimensiones y en cinco acabados, y ahora también en la versión con una temperatura de color de 3000 K, Sky-Fall decora tanto encendida como apagada. ●ES

Традиционная техника обработки стекла сочетается в Sky-Fall с наиболее совершенными светодиодными технологиями. Форма Sky-Fall захватывает воображение отсылкой к старинным декантерам из драгоценного дутого стекла. Он отличается поразительной функциональностью, благодаря инновационному двойному светодиодному источнику, который рассеивает прямой и непрямой свет. Светильник выпускается в двух размерах и пяти вариантах отделки, а теперь также в версии с цветовой температурой 3000 K. Sky-Fall украшает помещение как во включенном, так и в выключенном состоянии. ●RU

在Sky-Fall中,传统玻璃加工技术邂逅最为先进的LED技术。Sky-Fall的形状令人浮想联翩,忆起由珍稀吹制玻璃制成的古老醒酒器。它的功能令人叹为观止,这要归功于让直接与间接照明光线均可散射的创新型LED光源。提供两种尺寸和五个完成,现在还提供3000 K光色温版本, Sky-Fall在开启和关闭时都具有装饰性。●ZH

Visit website:



Sky-Fall medium ↘ Suspension lamp

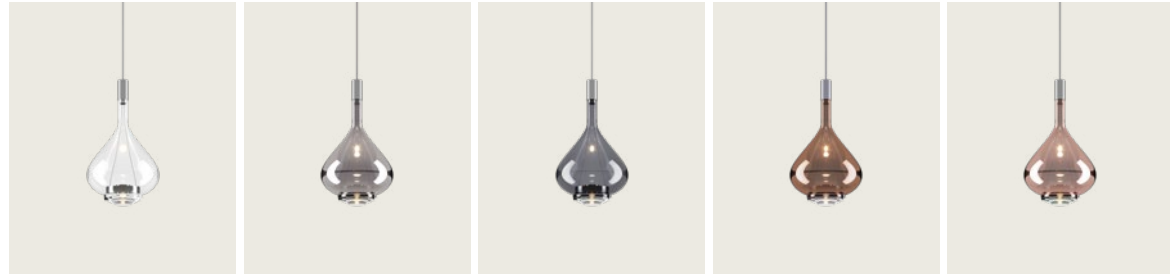

Sky-Fall large ↘ Suspension lamp

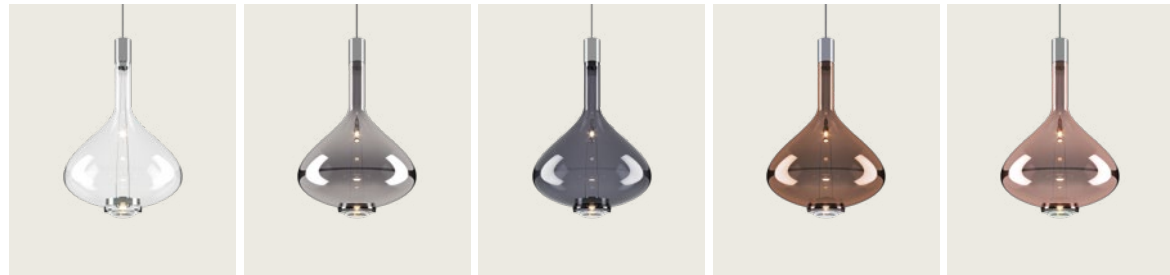

Sky-Fall double canopy Sky-Fall wall



Sky-Fall, design by Studio Italia Design, 2014

Suspension lamp

Sky-Fall medium

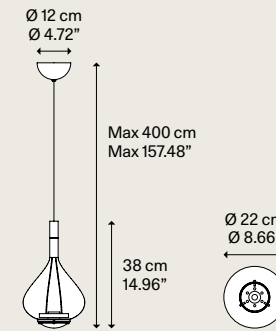

Light source
Sorgente luminosa

LED
↘ 2700 K
↘ 2 × 10 W/1815 lm
↘ 350 mA
↘ CRI 95
↘ MacAdam 3-Step

Metal structure
Montatura in metallo

Chrome
Cromo

Blown glass diffuser
Diffusore in vetro soffiato

Clear
Trasparente

Code
Codice

14822 0027

Chrome
Cromo

14822 4027

Glossy Smoke
Fumo Lucido

14822 4327

Glossy Bronze
Bronzo Lucido

14822 4627

Rose Gold
Oro Rosa

14822 5527

Clear
Trasparente

14822 0030

Chrome
Cromo

14822 4030

Glossy Smoke
Fumo Lucido

14822 4330

Glossy Bronze
Bronzo Lucido

14822 4630

Rose Gold
Oro Rosa

14822 5530

LED and driver included
LED e driver inclusi

Net weight/Peso netto: 1.65 kg

Pack/Coll: 2

Energy class/Classe energetica: E

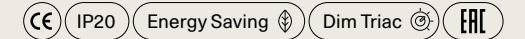

Sky-Fall large

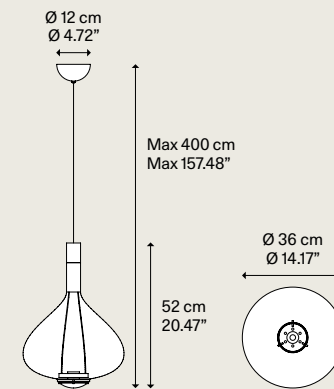

Light source
Sorgente luminosa

LED
↘ 2700 K
↘ 2 × 10 W/1815 lm
↘ 350 mA
↘ CRI 95
↘ MacAdam 3-Step

Chrome
Cromo

Clear
Trasparente

Code
Codice

14821 0027

Chrome
Cromo

14821 4027

Glossy Smoke
Fumo Lucido

14821 4327

Glossy Bronze
Bronzo Lucido

14821 4627

Rose Gold
Oro Rosa

14821 5527

Clear
Trasparente

14821 0030

Chrome
Cromo

14821 4030

Glossy Smoke
Fumo Lucido

14821 4330

Glossy Bronze
Bronzo Lucido

14821 4630

Rose Gold
Oro Rosa

14821 5530

LED and driver included
LED e driver inclusi

Net weight/Peso netto: 3.05 kg

Pack/Coll: 2

Energy class/Classe energetica: E

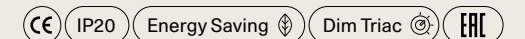

Ecodesign regulation ▶ pag. 444-445
Regolamento di Ecodesign ▶ pag. 444-445

Sky-Fall, design by Studio Italia Design, 2014

Canopy

Sky-Fall double canopy

Description Descrizione	Metal structure Montatura in metallo	System Sistema	Code Codice
Double canopy mod. Sky-Fall	Chrome Cromo	Sky-Fall System	R99L02 4000
Rosone doppio mod. Sky-Fall			

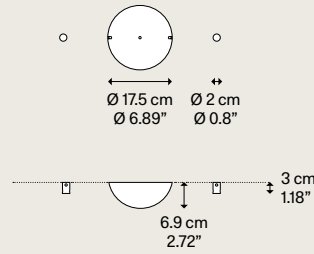

Net weight/Peso netto: 0.90 kg

Pack/Colli: 1



Wall Bracket

Sky-Fall wall

Description Descrizione	Metal structure Montatura in metallo	System Sistema	Code Codice
Wall bracket mod. Sky-Fall	Chrome Cromo	Sky-Fall System	R99L01 4000
Rosone a parete mod. Sky-Fall			

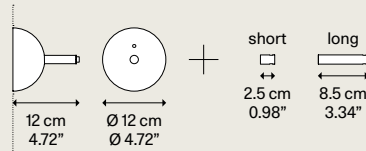

Net weight/Peso netto: 0.4 kg

Pack/Colli: 1



WALL ► Both accessories in the two available lengths are supplied in the box with the wall bracket.

WALL ► Entrambi gli accessori nelle due diverse lunghezze sono inclusi nella confezione con il supporto a parete.

Sky-Fall, design by Studio Italia Design, 2014

Track

Short Lights Track

Description Descrizione	Structure finish Finitura struttura	System Sistema	Code Codice
Multiple linear track mod. Sky-Fall max 3 suspensions	Matte White - 9010 Bianco Opaco - 9010	Track	R08L07 1000
Binario lineare multiplo mod. Sky-Fall max 3 sospensioni	Matte Black - 9005 Nero Opaco - 9005		R08L07 2000

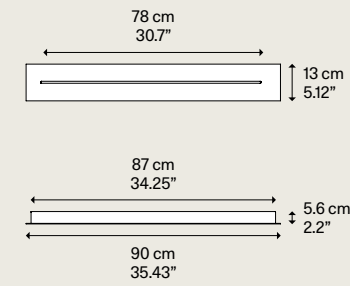

Net weight/Peso netto: 5.5 kg

Pack/Colli: 1



Long Lights Track

Description Descrizione	Structure finish Finitura struttura	System Sistema	Code Codice
Multiple linear track mod. Sky-Fall max 5 suspensions	Matte White - 9010 Bianco Opaco - 9010	Track	R08L11 1000
Binario lineare multiplo mod. Sky-Fall max 5 sospensioni	Matte Black - 9005 Nero Opaco - 9005		R08L11 2000

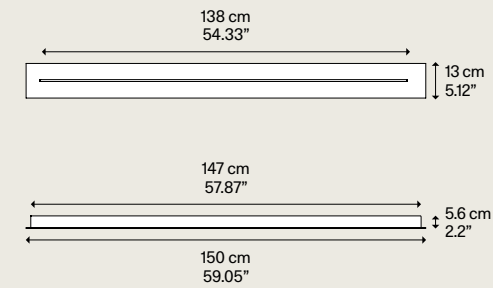

Net weight/Peso netto: 8.8 kg

Pack/Colli: 1



TRACK ► Tracks are only for Sky-Fall suspensions. Each suspension should be separated from the canopy and installed on the track. Each suspension should be installed on the track using the driver removed from the original canopy.

TRACK ► I binari sono utilizzabili solo con le sospensioni Sky-Fall che dovranno essere separate dai rosone ed installate sui binari. Per ogni sospensione dovrà essere installato nel binario il rispettivo driver rimosso dal rosone originale.

Flar

The name *Flar* evokes images of a flare or ‘flamboiemment’ in French – an intense blaze or burst of light. Inspired by traditional storm lanterns which use glass pipes to protect the flame, *Flar* comprises a 3D laser cut steel base which opens like a flower, leading to a charmingly imperfect blown glass diffuser available in two sizes, 45 and 60 cm. *Flar* features a dimmer controlled with the cable mounted power switch, allowing users to modulate the intensity of the light to create their ideal lighting scheme. The two sizes offer an opportunity to play with scale to create a unique composition for a hotel lounge or retail space.

Il nome *Flar* evoca l’immagine di uno sfavillio o “flamboiemment”, che in francese indica un intenso bagliore o squarcio di luce. Ispirata alle tradizionali lanterne antivento dotate di tubi in vetro per proteggere la fiamma, *Flar* si poggia su una base in acciaio, realizzata con la tecnologia del taglio laser 3D, che si schiude come un fiore e accoglie un diffusore in vetro soffiato dall’effetto piacevolmente imperfetto. Disponibile nelle due versioni da 45 e 60 cm, *Flar* è provvista di un varialuce regolabile dall’interruttore montato sul cavo, che consente all’utente di modulare l’intensità della luce in base alle proprie preferenze. Le due dimensioni offrono la possibilità di giocare con le proporzioni, creando così composizioni uniche nelle aree lounge degli hotel o nei punti vendita.

Table lamp, Floor lamp

Flar large and medium,
FINISHES Terra + Honey and
Champagne + Turquoise

Flar, design by Patrick Norguet, 2022





Flar large, FINISH Champagne + Honey



Flar medium and large, FINISHES Champagne + Honey and Champagne + Turquoise



Flar, blown glass diffuser, FINISHES Honey and Turquoise



Flar, 3D laser cut base, FINISH Champagne

Flar medium and large,
FINISHES Champagne + Honey
and Terra + Turquoise





Flar medium and large, FINISHES Terra + Turquoise and Terra + Honey



Flar, 3D laser cut base, FINISH Terra

Le nom *Flar* évoque un flamboiem (Flare en anglais) – une flamme intense ou un éclat de lumière. S'inspirant des lanternes tempête traditionnelles qui utilisent des cylindres de verre pour protéger la flamme, *Flar* se compose d'une base en acier découpée au laser 3D qui s'épanouit comme une fleur, portant à un diffuseur en verre soufflé d'une séduisante imperfection disponible en deux tailles, 45 et 60 cm. *Flar* dispose d'un variateur contrôlé par l'interrupteur d'alimentation monté sur câble, permettant à l'utilisateur de moduler l'intensité de la lumière pour créer l'éclairage idéal. Les deux tailles offrent la possibilité de jouer avec les variations pour une composition unique dans un hall d'hôtel ou un magasin. ●FR

Der Name *Flar* erinnert an eine Fackel oder 'flamboiem' im Französischen – ein intensives Aufflammen oder Ausbrechen von Licht. Inspiriert von traditionellen Sturmlaternen, die Glasrohre zum Schutz der Flamme verwenden, besteht *Flar* aus einer 3D-gelasierten Basis aus Stahl, die sich wie eine Blume öffnet und sich zu einem bezaubernden nicht perfekten Diffusor aus mundgeblasenem Glas entwickelt, der in zwei Größen erhältlich ist: 45 und 60 cm. *Flar* ist mit einem Dimmer ausgestattet, der über den am Kabel angebrachten Netzschalter gesteuert wird und es dem Benutzenden ermöglicht, die Intensität des Lichts zu modulieren, um das ideale Beleuchtungsschema zu schaffen. Die beiden Größen bieten die Möglichkeit, mit dem Maßstab zu spielen und eine einzigartige Komposition für eine Hotellounge oder einen Verkaufsraum zu schaffen. ●DE

El nombre *Flar* recoge ecos del término francés «flamboiem», una llamarada o un intenso estallido de luz. Inspirada por las tradicionales linternas de tormenta que empleaban tubos de vidrio para proteger la llama, *Flar* incluye una base de acero cortada con láser 3D y que se abre como una flor para dar paso a un difusor de vidrio soplado atractivamente imperfecto disponible en dos tamaños, 45 y 60 cm. *Flar* incorpora un regulador que se controla con el interruptor montado en el cable y permite a los usuarios modular la intensidad de la luz para crear su esquema de iluminación ideal. Los dos tamaños ofrecen la oportunidad de jugar con la escala para crear una composición única para el recibidor de un hotel o para una tienda. ●ES

Название *Flar* вызывает в воображении образы вспышки или французское слово «flamboiem», означающее интенсивное пламя или вспышку света. Вдохновленная традиционными штормовыми фонарями, в которых применяются стеклянные трубки для защиты пламени, лампа *Flar* имеет стальное основание 3D, вырезанное лазером, раскрывающееся подобно цветку, ведущее к очаровательно несовершенному диффузору из дутого стекла двух размеров: 45 и 60 см. *Flar* оборудована диммером, управляемым при помощи переключателя питания, монтированного на кабель, для модуляции интенсивности света, позволяя пользователям создавать идеальную схему освещения. Два размера предоставляют возможность играть с масштабом, чтобы создавать уникальные композиции для гостиничного холла или торгового помещения. ●RU

*Flar*这个名字让人联想到耀斑之像或法语的'flamboiem'一词—意为一股烈焰或一阵光耀。受到使用玻璃管保护火焰的传统防风灯的启发,*Flar*包含一个3D激光切割钢底座,它像花朵一样张开,形成一个优美迷人的不完美式吹制玻璃灯罩,提供45厘米和60厘米两种尺寸。*Flar*具有一个使用安装在线缆上的电源开关进行控制的调光器,使用户能够调节光线强度,以创建理想的照明方案。两种尺寸提供延展发挥的机会,可为酒店休息室或零售空间创建独特特别的组合。●ZH

Visit website:



Flar medium » Table lamp, Floor lamp



Flar large » Table lamp, Floor lamp



Flar, design by Patrick Norguet, 2022

Table lamp

Floor lamp

Flar medium

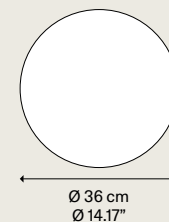
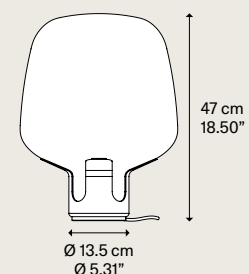

Net weight/Peso netto: 6.1 kg

Pack/Colli: 2

Light source
Sorgente luminosa

E27 T30
Tubular LED

L/W 225 mm

L/W 8.85"

» 1 x 25 W



Bulb not included
Dimmer on the
cord included

Lampadina non inclusa
Dimmer nel filo incluso

Metal structure
Montatura in metallo

Champagne
Champagne

Champagne
Champagne

Terra
Terra

Terra
Terra

Blown glass diffuser
Diffusore in vetro soffiato

Honey
Miele

Turquoise
Turchese

Honey
Miele

Turquoise
Turchese

Code
Codice

19182 6800

19182 8600

19183 6800

19183 8600



Flar large

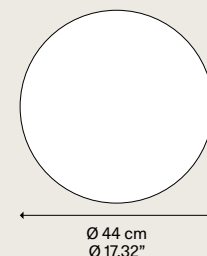
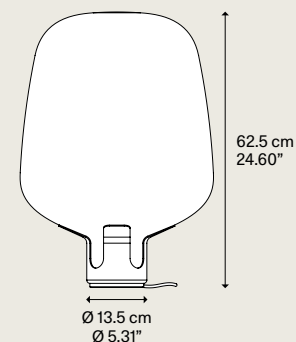

Net weight/Peso netto: 8 kg

Pack/Colli: 2

Light source
Sorgente luminosa

E27 T30
Tubular LED

L/W 300 mm

L/W 11.8"

» 1 x 25 W



Bulb not included
Dimmer on the
cord included

Lampadina non inclusa
Dimmer nel filo incluso

Metal structure
Montatura in metallo

Champagne
Champagne

Champagne
Champagne

Terra
Terra

Terra
Terra

Blown glass diffuser
Diffusore in vetro soffiato

Honey
Miele

Turquoise
Turchese

Honey
Miele

Turquoise
Turchese

Code
Codice

19184 6800

19184 8600

19185 6800

19185 8600



Hover

The Hover table and floor lamps feature a lamp shade that looks as if it is detached from the base, connected seamlessly by a single cable that runs through the stem and comes out of the other end. The end result creates an illusion that the light source is almost weightless and floating in the air, like a balloon. Hover features a dimmer controlled by a power switch on the upper end of the stem; users can simply touch the top of the stem to modulate the intensity of the light. All typically external technical functions have been carefully incorporated within the lamp's internal structure. Additionally, the power supply comes in the form of a USB cable.

Available as a table or floor lamp, Hover suits different uses such as on a desk, side table or next to a sofa. The floor lamp could also be used for public spaces including an airport lounge, a hotel room or lobby.

Le lampade da tavolo e da terra Hover presentano un paralume che sembra separato dalla base, collegato perfettamente da un unico cavo che attraversa lo stelo per poi uscirne. Il risultato finale crea l'illusione che la sorgente luminosa sia quasi priva di peso e fluttui nell'aria, come un palloncino.

Hover è dotata di un dimmer controllato da un interruttore di alimentazione posto all'estremità superiore dello stelo; gli utenti possono semplicemente toccare la parte superiore dello stelo per modulare l'intensità della luce. Tutte le funzioni tecniche tipicamente esterne sono state accuratamente incorporate nella struttura interna della lampada. Inoltre, l'alimentazione è fornita grazie ad un cavo USB.

Disponibile come lampada da tavolo o da terra, Hover si adatta a diversi usi, come ad esempio su una scrivania, un tavolino o accanto ad un divano. La versione da terra può essere utilizzata anche in spazi pubblici come in una lounge di un aeroporto, in una camera di un hotel o una hall.

Floor lamp, Table lamp

Hover table and floor,
FINISH Matte White

Hover, *design by YOY, 2022*





Hover table and floor, FINISH Matte White



Hover, USB socket

Hover table, FINISH Matte White



1



2

1–Hover, the lamp shade is connected seamlessly by a single cable that runs through the stem and comes out of the other end

2–Hover, switch on and off and dim the light intensity

Hover floor, FINISH Matte White





Hover table,
FINISH Matte White



1

1-Hover, the shade comprises a sheet made from a special compound of paper and polymer film



Hover table, FINISH Matte White



Hover floor and table,
FINISH Matte White

L'abat-jour des lampes de table et des lampadaires Hover semble séparé de la base et parfaitement relié par un câble unique qui traverse entièrement la tige. Le résultat final crée l'illusion d'une source lumineuse qui flotte dans l'air quasiment en apesanteur, comme un ballon. Hover est équipé d'un gradateur commandé par un interrupteur d'alimentation situé à l'extrémité supérieure de la tige ; les utilisateurs n'ont qu'à toucher le haut de la tige pour moduler l'intensité de la lumière. Toutes les fonctions techniques habituellement externes ont été soigneusement intégrées dans la structure interne de la lampe. En outre, l'alimentation est fournie via un câble USB. Disponible en lampe de table ou en lampadaire, Hover convient à différents usages, comme lampe de bureau, de table basse ou à côté d'un canapé. La version au sol peut également être installée dans des espaces publics tels qu'un lounge d'aéroport, une chambre d'hôtel ou un hall. ● FR

Die Tisch- und Stehleuchten Hover verfügen über einen Leuchtschirm, der vom Sockel getrennt zu sein scheint, verbunden auf perfekte Weise durch ein einziges Kabel, das durch den Schaft hindurch und aus ihm herausführt. Das Endergebnis erzeugt die Illusion, dass die Lichtquelle fast schwerelos ist und wie ein Ballon in der Luft schwebt. Hover ist mit einem Dimmer ausgestattet, der über einen Schalter am oberen Ende des Schaftes reguliert wird; die Benutzer können die Lichtintensität durch einfaches Berühren des oberen Endes des Schaftes einstellen. Alle typischen externen technischen Funktionen wurden sorgfältig in die innere Struktur der Leuchte integriert. Außerdem erfolgt die Stromversorgung über ein USB-Kabel. Erhältlich als Tisch- oder Stehleuchte, eignet sich Hover für verschiedene Verwendungszwecke, z. B. auf einem Schreibtisch, einem Beistelltisch oder neben einem Sofa. Die Bodenversion kann auch in öffentlichen Räumen wie einer Flughafenlounge, einem Hotelzimmer oder einer Empfangshalle eingesetzt werden. ● DE

Las lámparas de sobremesa y de pie Hover poseen una pantalla que parece separada de la base, conectada perfectamente por un solo cable que atraviesa la barra y luego sale. El resultado final da la sensación de que la fuente luminosa prácticamente no pesa y flota en el aire, como un globo. Hover está equipada con un regulador que controla un interruptor de alimentación situado en el extremo superior de la barra; los usuarios, simplemente tocando la parte superior de la barra, pueden regular la intensidad de la luz. Todas las funciones técnicas que normalmente están fuera se han incorporado minuciosamente en la estructura interna de la lámpara. Además, la alimentación se suministra gracias a un cable USB. Hover, disponible como lámpara de sobremesa o de pie, se adapta a distintos usos, como por ejemplo en un escritorio, una mesita o junto a un sofá. La versión de pie también se puede utilizar en espacios públicos como en la sala de un aeropuerto, una habitación de hotel o un vestíbulo. ● ES

Настольные лампы и торшеры Hover имеют абажур, который кажется отделенным от основания и соединенным одним кабелем, пересекающим стержень, а затем выходящим наружу. В результате возникает иллюзия невесомости источника света, парящего в воздухе, как воздушный шар. Hover оснащен диммером, управляемым выключателем, расположенным на верхнем конце стержня; пользователи могут отрегулировать интенсивность света, просто прикоснувшись к верхней части стержня. Все технические функции, обычно находящиеся снаружи, были встроены во внутреннюю структуру светильника. Питание также подается по кабелю USB. Hover выпускается в виде настольной лампы или торшера, и подходит для различного применения, на письменном столе, журнальном столике или рядом с диваном. Напольный вариант может также устанавливаться в общественных зданиях, например в зале аэропорта, в гостиничном номере или в холле. ● RU

Hover的台灯款和落地灯款均带有一个看似与底座分开的灯罩，但灯罩与底座之间却由一根从灯罩部位穿插而过的单根线缆完美连接。最终结果营造一种幻觉，光源仿佛几乎没有重量且会像气球一般漂浮于空中。Hover配有一部由位于灯罩上端的电源开关控制的调光器；用户只需轻触灯罩顶部便可调节光的强度。所有典型的外部技术功能均已巧妙整合至灯件的内部结构之中。此外，电源供给是通过一根USB线缆完成的。Hover提供台灯或落地灯两个版本，适用于不同用途，例如放在书桌、咖啡桌上或沙发近旁。落地灯版本也可用于机场休息室、酒店房间或大堂等公共场所。● ZH

Visit website:



Hover, design by YOY, 2022

Floor lamp

Hover NEW

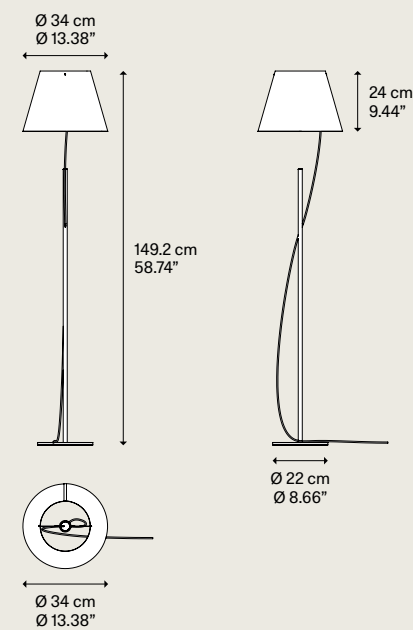

Net weight/Peso netto: 6 kg

Pack/Colli: 1

Energy class/Classe energetica: C

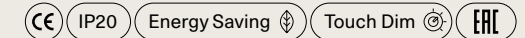
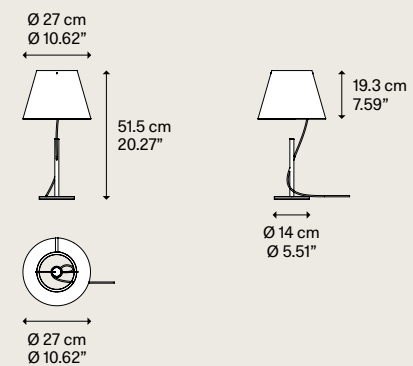

Table lamp

Hover NEW



Net weight/Peso netto: 2.2 kg

Pack/Colli: 1

Energy class/Classe energetica: C

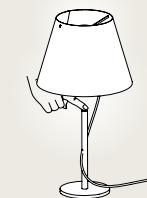
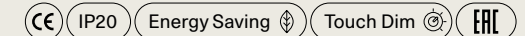

Ecodesign regulation ► pag. 444-445
Regolamento di Ecodesign ► pag. 444-445

Easy Peasy

With a strong personality and a sculptural form reminiscing the shape of bells, *Easy Peasy* is a set of portable and rechargeable table lamps, consisting of two rounded elements, a body and a knob. Made of blown glass, *Easy Peasy* allows for personal customisation of the living spaces. Its portability, different shapes and colours, and the *dim-to-warm* functionality of its light source allow users to connect, play and interact with the variable configuration options. It is not just a table lamp: it is a real character to interact with!

Con una spiccata personalità e una linea sculturale che ricorda la forma delle campane, *Easy Peasy* è un set di lampade da tavolo portatili e ricaricabili, composte da due elementi stoncati, un corpo e un pomolo. Realizzata in vetro soffiato, *Easy Peasy* permette la personalizzazione individuale degli spazi abitativi. La sua portabilità, le diverse forme e colori e la funzione *dim-to-warm* della sorgente luminosa a LED permettono agli utenti di interagire, giocare e dialogare con le differenti possibilità di configurazione della luce. Non è solo una lampada da tavolo: è un vero e proprio personaggio con cui interagire!

Cordless table lamp

Easy Peasy family,
Lagoon, Flamingo, Kelp and Chestnut

Easy Peasy, design by Luca Nichetto, 2020





Easy Peasy, knob, glass bell, diffuser

Easy Peasy,
Chestnut and Kelp



Easy Peasy,
Flamingo and Lagoon



Easy Peasy, Chestnut and Flamingo

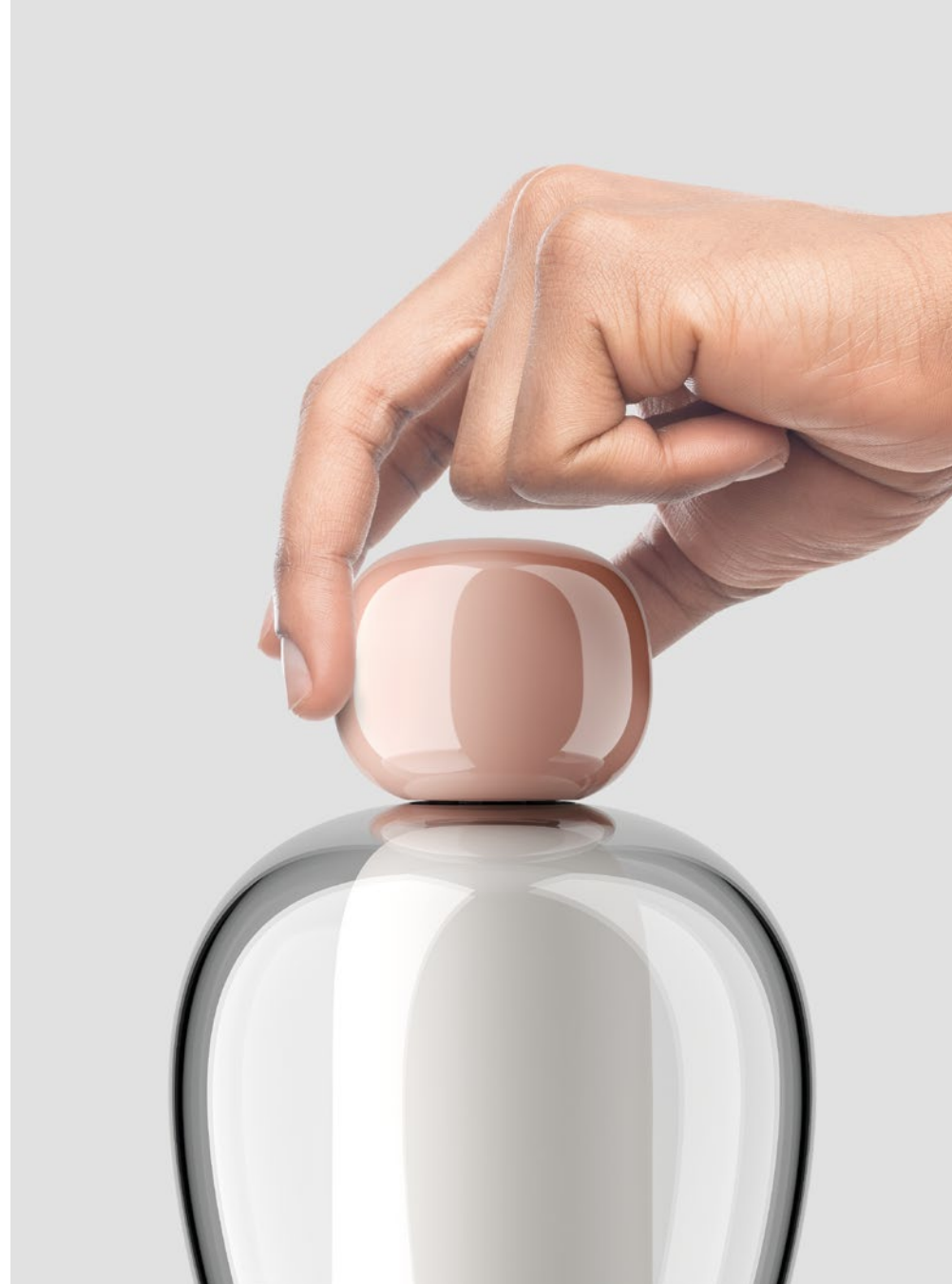

Easy Peasy, turn on and off, dim light intensity and warmth



Easy Peasy, portable and rechargeable table lamp



Easy Peasy, micro USB socket

Avec sa forte personnalité et une ligne sculpturale qui rappelle la forme des cloches, *Easy Peasy* est un ensemble de lampes sur table portables et rechargeables, composé de deux éléments arrondis, un corps et un pommeau. Réalisée en verre soufflé, *Easy Peasy* permet la personnalisation individuelle des espaces de vie. Sa portabilité, ses différentes formes et couleurs et la fonction « *dim-to-warm* » de la source lumineuse à LED permettent aux utilisateurs d'interagir, de jouer et de dialoguer avec les différentes possibilités de configuration de la lumière. Ce n'est pas seulement une lampe de table : c'est un véritable personnage avec lequel on peut interagir ! ● FR

Mit einer besonderen Persönlichkeit und einer skulpturalen Linie, die an die Form einer Glocke erinnert, ist *Easy Peasy* ein Set aus mitnehmbaren und aufladbaren Tischleuchten, bestehend aus zwei abgerundeten Elementen, einem Korpus und einem Knauf. Aus geblasenem Glas hergestellt, ermöglicht *Easy Peasy* eine individuelle Personalisierung der Wohnräume. Die Mitnehmbarkeit, die verschiedenen Formen und Farben sowie die Funktion *Dim-to-warm* der LED-Lichtquelle ermöglichen den Nutzern mit den verschiedenen Konfigurationsmöglichkeiten für das Licht zu interagieren, zu spielen und in Dialog zu treten. Es ist nicht nur eine Tischlampe: Es ist eine echte Figur, mit der man interagieren kann. ● DE



Easy Peasy, packaging

Con una marcada personalidad y una línea escultural que recuerda la forma de las campanas, *Easy Peasy* es un set de lámparas de sobremesa portátiles y recargables, compuestas por dos elementos redondeados, un cuerpo y un pomo. Realizada en vidrio soplado, *Easy Peasy* permite la personalización individual de los espacios habitacionales. Su portabilidad, las diversas formas y colores y la función *dim-to-warm* de la fuente luminosa a LED permiten a los usuarios interactuar, jugar y dialogar con las diferentes posibilidades de configuración de la luz. No es sólo una lámpara de mesa: es un personaje real con el que interactuar. ● ES

Обладающие ярко выраженной индивидуальностью и скульптурным силуэтом, напоминающим форму колокола, светильники *Easy Peasy* – это серия портативных перезаряжаемых настольных ламп, состоящих из двух закругленных элементов, корпуса и ручки. Лампы *Easy Peasy*, изготовленные из выдувного стекла, придают оформлению жилого пространства самобытность и оригинальность. Портативность, разнообразие форм и цветов, а также функция *dim-to-warm* источника света LED позволяют пользователям взаимодействовать, фантазировать и применять возможности различных конфигураций освещения. Это не только настольный светильник – это настоящий персонаж с которым можно контактировать. ● RU

*Easy Peasy*具有强烈的个性和雕塑感，酷似铃铛的形状，它是一组便携式可充电台灯，由两个圆形元素组成，一个主体和一个圆头。台灯由吹制玻璃制成，*Easy Peasy* 可实现生活空间的个性化定制。它的便携性、不同的形状和颜色及其LED光源 *dim-to-warm* 的调光功能，允许用户与不同的灯光配置选项进行交互、游戏和对话。*Easy Peasy*不仅是盏台灯：它是一个具有个性能与空间互动的活泼伙伴 ● ZH

Visit website:



Flamingo
↘ Cordless table lamp

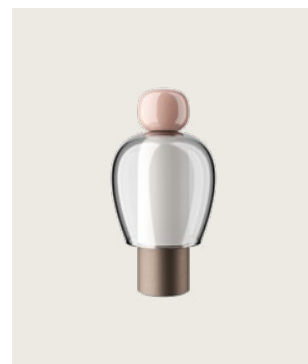

Lagoon
↘ Cordless table lamp

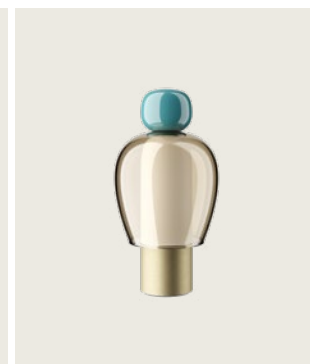

Kelp
↘ Cordless table lamp

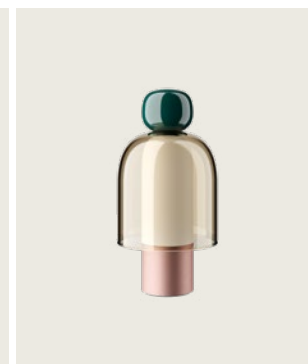

Chestnut
↘ Cordless table lamp



Easy Peasy, design by Luca Nichetto, 2020

Cordless table lamp

Easy Peasy

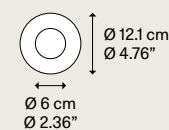
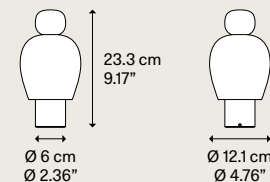

Light source
Sorgente luminosa

Technopolymer knob
Pomolo in tecnopolimero

Blown glass shade
Cappello in vetro soffiato

Metal base
Base in metallo

Code
Codice

Flamingo

LED
↘ Dim-to-warm
from 2700 K
to 3300 K
↘ 3 W/380 lm
↘ 2000 mA Battery
↘ CRI 90
↘ MacAdam 3-Step

Pink
Rosa

Grey
Grigio

Brushed
Bronze
Bronzo
Spazzolato

17081 6226

LED and battery included
LED e batteria inclusi

Lagoon

LED
↘ Dim-to-warm
from 2700 K
to 3300 K
↘ 3 W/380 lm
↘ 2000 mA Battery
↘ CRI 90
↘ MacAdam 3-Step

Turquoise
Turchese

Honey
Miele

Brushed
Gold
Oro
Spazzolato

17081 8126

LED and battery included
LED e batteria inclusi

Net weight/Peso netto: 0.85 kg

Pack/Colli: 1

Energy class/Classe energetica: D



IP20

Energy Saving

Dim-to-Warm



Easy Peasy

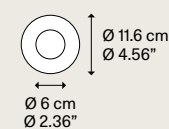
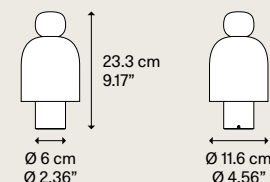

Light source
Sorgente luminosa

Technopolymer knob
Pomolo in tecnopolimero

Blown glass shade
Cappello in vetro soffiato

Metal base
Base in metallo

Code
Codice

Kelp

LED
↘ Dim-to-warm
from 2700 K
to 3300 K
↘ 3 W/380 lm
↘ 2000 mA Battery
↘ CRI 90
↘ MacAdam 3-Step

Green
Verde

Honey
Miele

Brushed
Rose Gold
Oro Rosa
Spazzolato

17081 7226

LED and battery included
LED e batteria inclusi

Chestnut

LED
↘ Dim-to-warm
from 2700 K
to 3300 K
↘ 3 W/380 lm
↘ 2000 mA Battery
↘ CRI 90
↘ MacAdam 3-Step

Taupe
Grigio Caldo

Grey
Grigio

Brushed
Palladium
Palladio
Spazzolato

17081 3826

LED and battery included
LED e batteria inclusi

Net weight/Peso netto: 0.85 kg

Pack/Colli: 1

Energy class/Classe energetica: D



IP20

Energy Saving

Dim-to-Warm



Ecodesign regulation ► pag. 444-445
Regolamento di Ecodesign ► pag. 444-445

Battery charging time
Tempo di ricarica

Power supply 1A ► 180 min

Battery life
Durata batteria

Full power 100% ► 6h
Half power 50% ► 10h
Minimum power 10% ► 19h

Blow

As light as a breath, Blow is an ethereal and original table lamp. Made from blown glass, it contains a bright light that can be directed inside the diffuser to create ever-different beams. Perfect for reading or furnishing personal and intimate spaces.

Leggera come un respiro, Blow è una lampada da tavolo eterea e ingegnosa. Realizzata in vetro soffiato, contiene una luce vivace che si può orientare all'interno del diffusore per creare fasci luminosi ogni volta diversi. Ideale per leggere e per arredare spazi personali e intimi.

Table lamp

Blow,
FINISH Clear

Blow, *design by* Pio & Tito Toso, 2005





Blow, FINISH Clear

Blow,
FINISH Clear

Légère comme un souffle, Blow est une lampe sur table éthérée et ingénieuse. Réalisée en verre soufflé, elle renferme une lumière vivace qui peut être orienté à l'intérieur du diffuseur pour créer des faisceaux de lumière tous différents. Idéale pour la lecture et pour décorer les espaces personnels et intimes. ● FR

So leicht wie der Atem ist Blow eine himmlische und erfinderische Tischlampe. Hergestellt aus mundgeblasenem Glas, enthält die Leuchte ein lebhaftes Licht, das innen im Diffusor ausgerichtet werden kann, um stets neue Lichtstreifen entstehen zu lassen. Ideal zum Lesen und zum Einrichten persönlicher und intimer Räume. ● DE

Ligera como un suspiro, Blow es una etérea e ingeniosa lámpara de sobremesa. Fabricada en vidrio soplado, contiene una luz brillante que puede orientarse dentro del difusor para crear diferentes haces de luz cada vez. Ideal para leer y para decorar espacios personales e íntimos. ● ES

Легкий как дыхание, Blow – это изящный и очень оригинальный настольный светильник. Этот светильник, изготовленный из выдувного стекла, заключает в себе живой и динамичный свет, который можно ориентировать внутри диффузора для создания всякий раз других световых пучков. Идеально подходит для чтения и для оформления личных и интимных пространств. ● RU

轻如呼吸，Blow是一款灵动而巧妙的台灯。由吹制玻璃制成，含有充满活力的光线，可以将其定向到灯罩的内部，每次发出不同的光束。阅读和布置个人和私密空间的理想之选。● ZH

Visit website:



Blow, design by Pio & Tito Toso, 2005

Table lamp

Blow

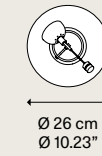
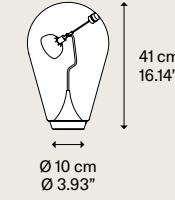

Light source Sorgente luminosa	Metal structure Montatura in metallo	Blown glass diffuser Diffusore in vetro soffiato	Code Codice
LED ↘ 2700 K ↘ 4.5 W / 500 lm ↘ 500 mA ↘ CRI 90 ↘ MacAdam 3-Step	Chrome Cromo	Clear Trasparente	00880 27

LED and driver included
LED e driver inclusi

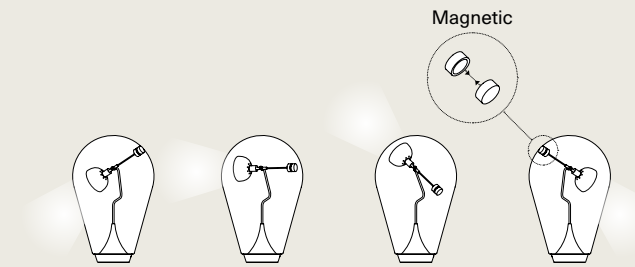

Adjustable light
Luce orientabile

Net weight / Peso netto: 4.00 kg

Pack / Colli: 1

Energy class / Classe energetica: C

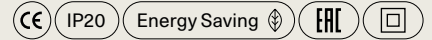

Ecodesign regulation ► pag. 444-445
Regolamento di Ecodesign ► pag. 444-445

Blow ▾ Table lamp



Croma

Taking its name from the Italian word for a 'quaver' or 'eighth', *Croma* reflects the dynamism of the musical note in its slender frame. It features a conical base that provides stability and a sleek body which casts a powerful ray of light from its LED source. A ring conveniently positioned halfway up the stem allows the user to control the LED module, and to utilise its *dim-to-warm* function. Its two unique metallic ombré colourways and the two texturised white and black finishes make *Croma* suitable for a variety of environments, including residential, hotel and hospitality.

La nuova lampada da terra richiama nel nome la "croma" o "ottavo": la sua struttura slanciata che proietta fasci di luce lungo la parete verso il soffitto evoca il dinamismo della nota musicale. Croma ha una base conica che le conferisce stabilità e una silhouette longilinea che proietta un potente raggio di luce dalla sorgente LED. Un anello posizionato a metà altezza dello stelo consente all'utente di regolare il modulo a LED e gestire la funzione *dim-to-warm*. Le due finiture metallizzate ombré, e le due tonalità testurizzate bianco e nero rendono *Croma* adatta a una varietà di ambienti, dal residenziale all'hotel e ospitalità.

Floor lamp

Croma, FINISHES Matte White and Matte Black

Croma, design by Luca Nichetto, 2021





Croma, turn on and off, dim light intensity and warmth

Croma, FINISHES Matte Black
and Matte White





Croma,
FINISH Green



Croma, Light source



Croma,
FINISH Matte Black



1

1-Croma, turn on and off,
dim light intensity and warmth

Croma,
FINISH Bronze



Croma, Dim-to-warm *from 2200 to 3200 K*

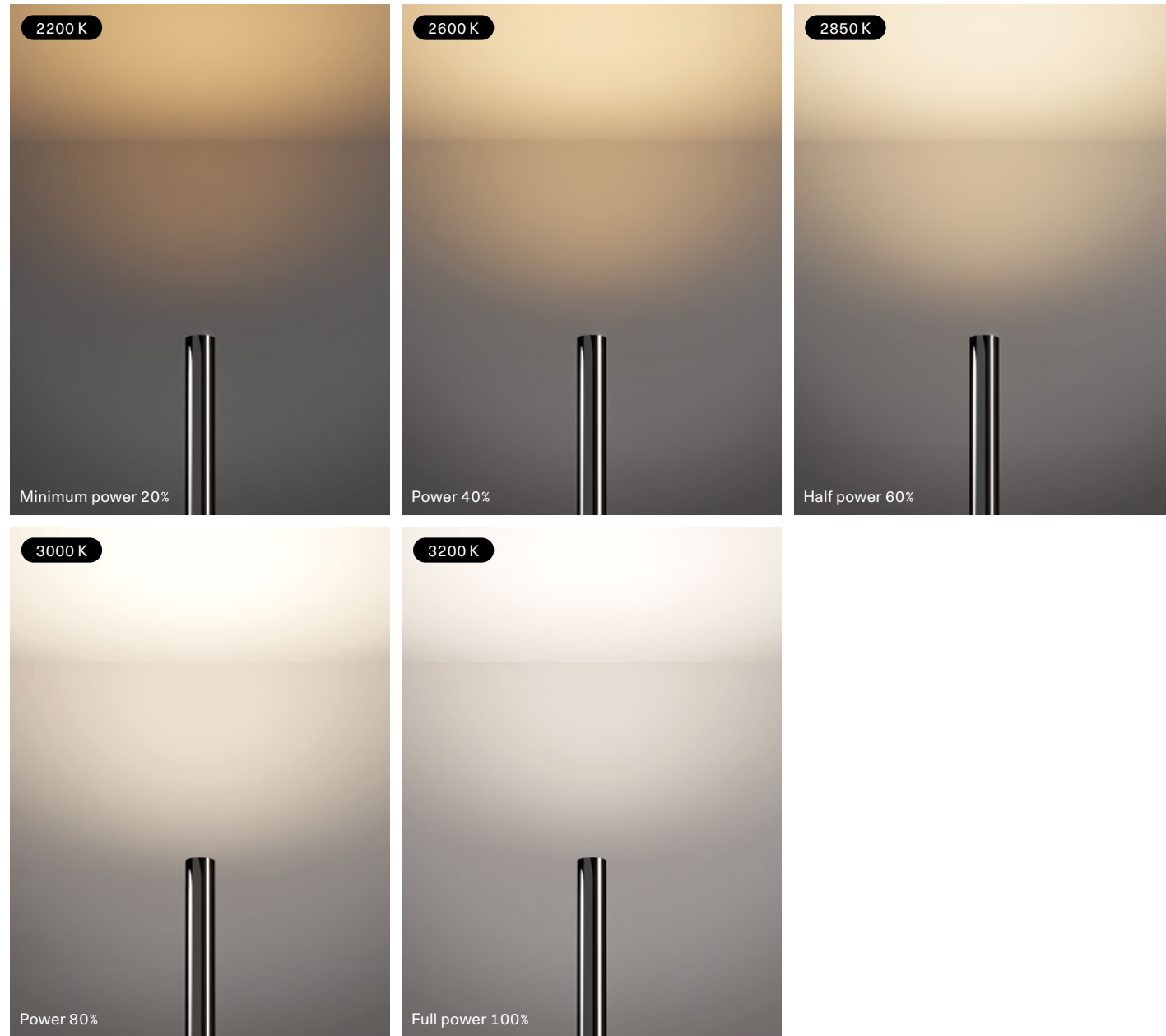

Croma Green, dim-to-warm function

Le nouveau lampadaire prend son nom du mot italien désignant une *croche* ou une *hampe* : sa structure élancée dissipe les faisceaux de lumière vers le haut du mur et le plafond pour évoquer le dynamisme de la note de musique. *Croma* s'appuie sur une base conique qui assure sa stabilité et lui donne une allure longiligne qui projette un puissant rayon de lumière de la source LED. Un anneau placé à mi-hauteur de la hampe permet à l'utilisateur de contrôler le module LED et de gérer la fonction *dim-to-warm*. Grâce aux deux nouvelles finitions métallisées ombré et aux deux tonalités texturées blanche et noire, *Croma* épouse toute une variété d'ambiances, du résidentiel à l'hôtellerie et à l'accueil. ●FR

Der Name der neuen Stehleuchte leitet sich vom italienischen Wort für "Achtelnote" oder "Achtel" ab: Ihre schlanke Struktur, die die Lichtstrahlen entlang der Wand in Richtung Decke projiziert, spiegelt die Dynamik der Musiknote wider. *Croma* hat einen konischen Sockel, der ihr Stabilität verleiht und eine langgestreckte Silhouette, die einen kraftvollen Lichtstrahl aus dem LED-Leuchtmittel abgibt. Ein auf halber Höhe des Ständers angebrachter Ring ermöglicht dem Benutzer, das LED-Modul zu steuern und die *Dim-to-Warm-Funktion* zu nutzen. Metallische Ombré Ausführungen und zwei strukturierte Schwarz- und Weißtöne ermöglichen den Einsatz von *Croma* in einer Vielzahl von Umgebungen, vom Wohnbereich bis hin zu Hotels und Hospitality. ●DE

La nueva lámpara de pie evoca en el nombre la *corchea* o *octava*: su estructura estilizada que proyecta haces de luz en la pared hacia el techo evoca el dinamismo de la nota musical. *Croma* descansa sobre una base cónica queda estabilidad a su silueta alargada que proyecta un potente rayo de luz de la fuente LED. Un anillo situado a media altura del pie le permite al usuario regular el módulo LED y controlar la función *dim-to-warm*. Los dos nuevos acabados metalizados ombré y los dos colores texturizados blanco y negro hacen que *Croma* sea apropiada para distintos ambientes, del residencial pasando por el hotelero a la hostelería. ●ES

Новый торшер напоминает своим названием итальянское слово «сромта» или «восьмой»: его утонченная структура, проецирующая лучи света вдоль стены к потолку, ассоциируется с динамизмом музыкальной ноты. *Croma* имеет коническое основание, которое придает лампе устойчивость и утонченность силуэта. Лампа проецирует мощный луч света от светодиодного источника. Кольцо, расположенное на середине ноги торшера, позволяет пользователю регулировать светодиодный модуль и управлять функцией *dim-to-warm*. Две новые металлизированные отделки деграде и две новые текстурированные тональности черного и белого делают лампу *Croma* подходящей для самых разных применений, от жилых помещений до отелей и структур по приему гостей. ●RU

新款落地灯呼应“颤音”或“八分音符”之名:纤细修长的结构沿着墙壁向天花板散射光束,唤起音符之活力。 *Croma*有一个锥形底座上,该底座为其赋予稳定性以及一个可从LED光源投射出强烈光线的纤长轮廓。一只位于灯茎一半处的圆环使用户能够调整 LED 模块并管理从暗到暖的调光功能。两种金属渐变效果饰面以及纯白色和黑色两种纹理色调,使*Croma*适用于包括住宅、酒店及招待场所在内的各类环境。●ZH

Visit website:



Croma, design by Luca Nichetto, 2021

Floor lamp

Croma

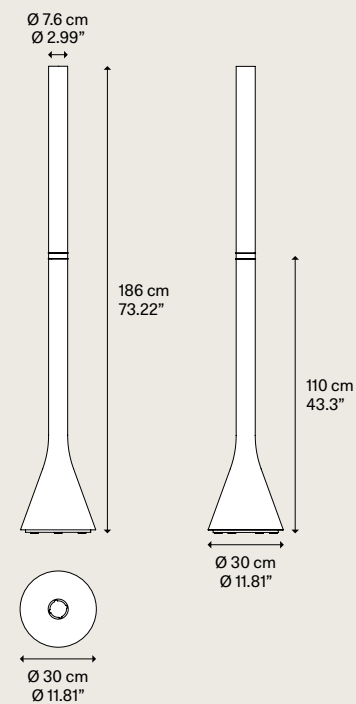

Light source Sorgente luminosa

LED
 ▾ Dim-to-warm from 2200 K to 3200 K
 ▾ 42 W/5600 lm
 ▾ 220-240 V
 ▾ CRI 90
 ▾ MacAdam 3-Step

Metal structure Montatura in metallo

- Matte White – 9010
Bianco Opaco – 9010
- Matte Black – 9005
Nero Opaco – 9005
- Bronze
Bronzo
- Green
Verde

Code Codice

- 17270 1000
- 17270 2000
- 17270 3400
- 17270 7000

Dim-to-warm

▶ 20%	2200 K	1400 lm
▶ 40%	2600 K	2400 lm
▶ 60%	2850 K	3550 lm
▶ 80%	3000 K	4600 lm
▶ 100%	3200 K	5600 lm

LED, driver and Dim-to-warm dimmer included
 LED, driver e Dim-to-warm dimmer inclusi

Net weight/Peso netto: 15 kg

Pack/Colli: 1

Energy class/Classe energetica: E



Ecodesign regulation ▶ pag. 444-445
 Regolamento di Ecodesign ▶ pag. 444-445

Croma ▾ Floor lamp



Cima

Inspired by the function of the jam cleats found in sailing boats, Cima – a nautical rope in Italian – is a “suspended” lamp characterised by a ceiling-to-floor rope, a sleek and highly functional design element. A joint that holds the lamp body slides vertically along the rope, while the counterweight allows to manage any excess rope. The simple cylindrical shapes and the black colour of these elements highlight the three brilliant finishes of the rope, vibrant accents to suit any interiors and décor mood.

Ispirata dalla funzione degli strozzascotte delle barche a vela, Cima è una lampada “sospesa” caratterizzata da una fune a tutt’altezza, elemento di design elegante e altamente funzionale. Lungo la fune scorre verticalmente un giunto che regge il corpo lampada, mentre il contrappeso permette di gestire l’eventuale fune in eccesso. Le semplici forme cilindriche e il colore nero di questi elementi risaltano le tre finiture brillanti della fune, accenti vibranti per qualsiasi ambiente e mood d’arredo.

Suspension lamp, Floor lamp

Cima,
FINISHES Yellow, Silver and Gold

Cima, *design by* Marco Dessì, 2021



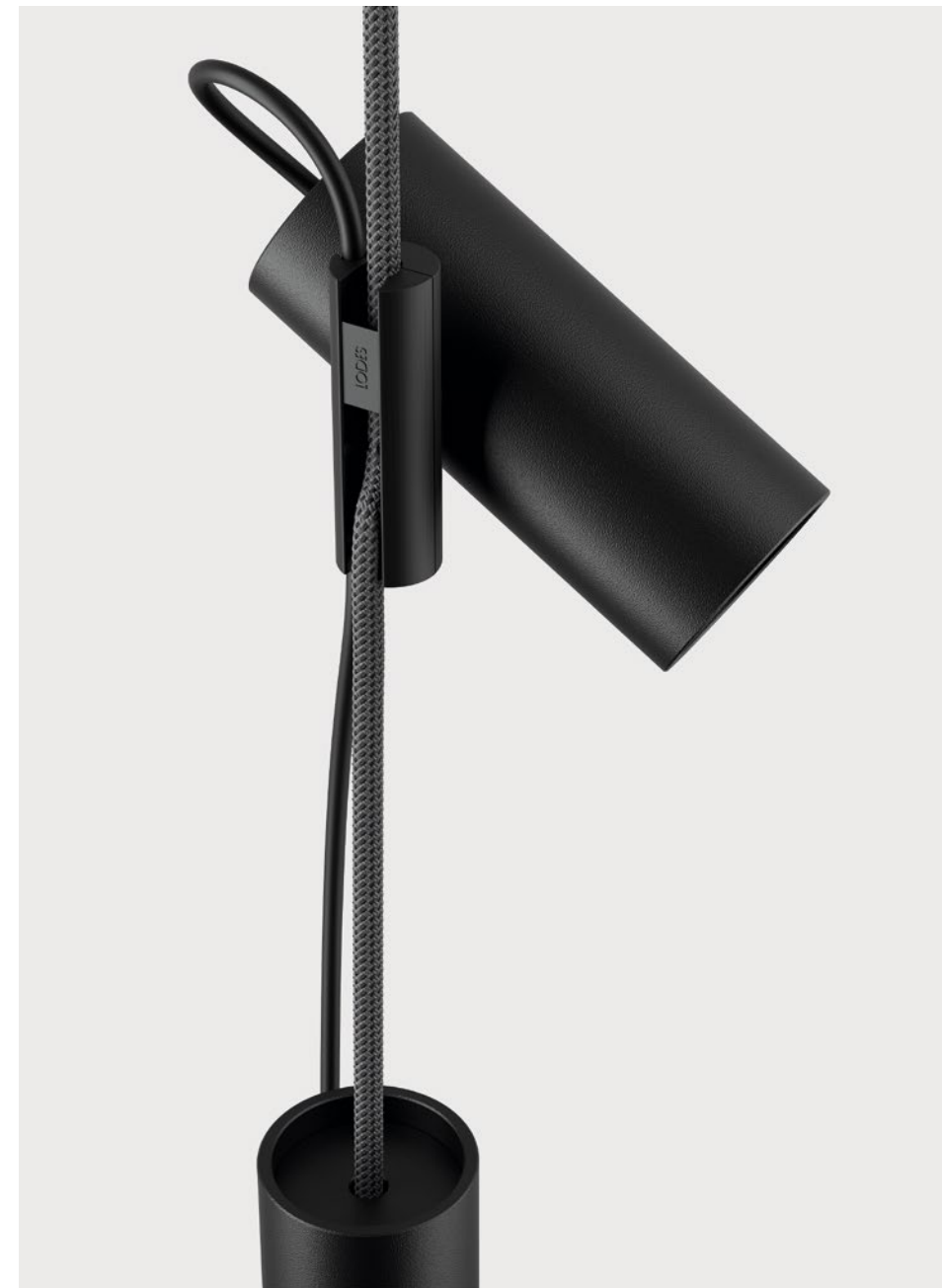

Cima, FINISH Silver

Cima, FINISH Gold



1



2

1–Cima, FINISH Silver, set the rope at the desired length

2–Cima, FINISH Silver, counterweight / switch button on the power cord



Cima, FINISH Yellow



Cima, FINISH Silver

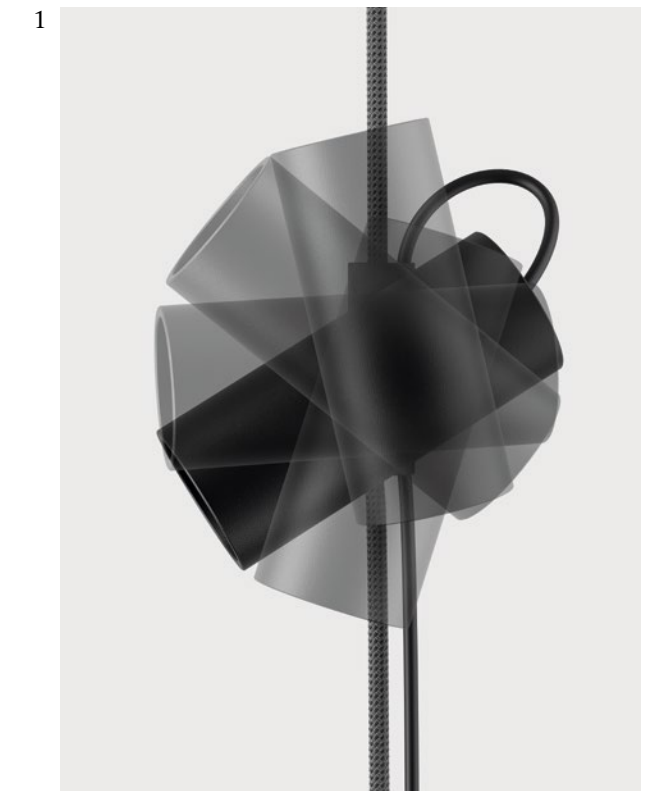

Cima, easy personalisation of light:
1-Change the angle of the lamp body

2-Adjust the height of the joint

S'inspirant de la fonction des taquets de blocage des voiliers, Cima – une corde nautique en italien – est une lampe « suspendue » caractérisée par une corde plafond-sol, élément de design élégant et fonctionnel. Le raccord qui supporte le corps de la lampe se déplace le long de la corde, tandis que le contrepoids permet d'ajuster l'excès de corde. Les formes cylindriques simples et la couleur noire de ces éléments mettent en valeur les trois finitions brillantes de la corde pour s'adapter à tous les intérieurs et à tous les styles de décoration. ● FR

Inspiriert von der Funktion der Klampen, die in Segelbooten zu finden sind, ist Cima – das bedeutet Schiffsseil auf Italienisch – eine „hängende Leuchte“, die sich durch ein Decken-Boden-Seil auszeichnet, ein elegantes und hoch funktionales Designelement. Entlang des Seils bewegt sich ein Gelenk, das den Lampenkörper stützt, während das Gegengewicht es ermöglicht, einen eventuellen Seilüberschuss zu justieren. Die schlichten Formen und die schwarze Farbe dieser Elemente unterstreichen die drei brillanten Ausführungen des Seils, vibrierende Akzente, die für jedes Interieur und jede Dekor Stimmung geeignet sind. ● DE

Inspirada en la función de las cornamusas que se encuentran en los veleros, Cima – una cuerda náutica en italiano – es una lámpara “suspendida” caracterizada por una cuerda que va del techo al suelo, un elemento de diseño elegante y sumamente funcional. A lo largo de la cuerda se mueve verticalmente una articulación que sujeta el cuerpo de la lámpara, mientras que el contrapeso permite reajustar cualquier exceso de cuerda. Las sencillas formas cilíndricas y el color negro de estos elementos resaltan los tres acabados brillantes de la cuerda, las notas vibrantes de cualquier interior y decoración de ambiente. ● ES

Вдохновленный функцией палубных стопоров, используемых на парусных лодках, светильник Cima – «корабельный канат» на итальянском – представляет собой подвешенную лампу, с тросом в полную высоту, задуманным как изысканный и высоко функциональный элемент дизайна. Вдоль троса вертикально перемещается шарнир, поддерживающий корпус лампы, а противовес позволяет отрегулировать избыток троса. Простые цилиндрические формы и черный цвет этих элементов подчеркивают три яркие отделки троса, вибрирующие тональности, подходящие для любых интерьеров и стилей. ● RU

受帆船中防滑钉的功能之启发,Cima—意大利语意为航海绳—是一款特征显著的“悬浮灯”,一条全高式绳索便是其优雅且功能强大的设计元素。一块用来举持灯体的接头沿绳索垂直延伸,而配重件则可让您调节管理绳索的任何多余之处。这些元素的简约圆柱形状与黑色突出了绳索的三种光鲜饰面,令任何室内环境与装饰风尚活力四射。● ZH

Visit website:



Cima » Suspension lamp, Floor lamp

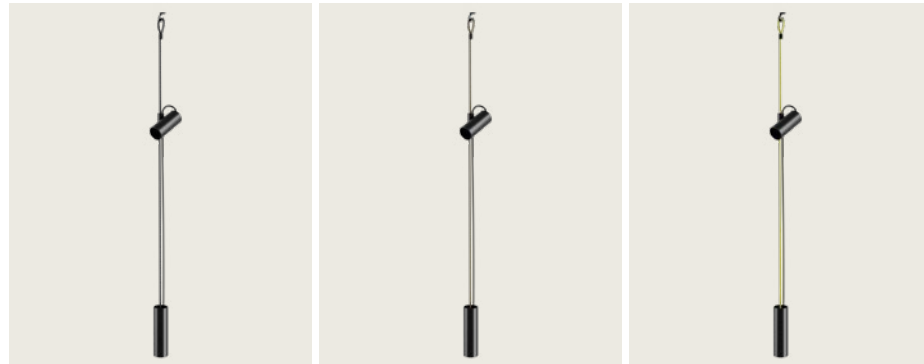

Finishes » Rope

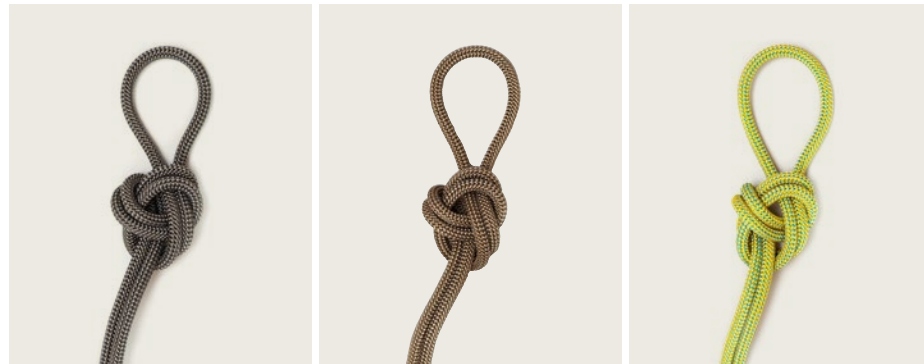

Cima, design by Marco Dessí, 2021

Suspension lamp

Floor lamp

Cima

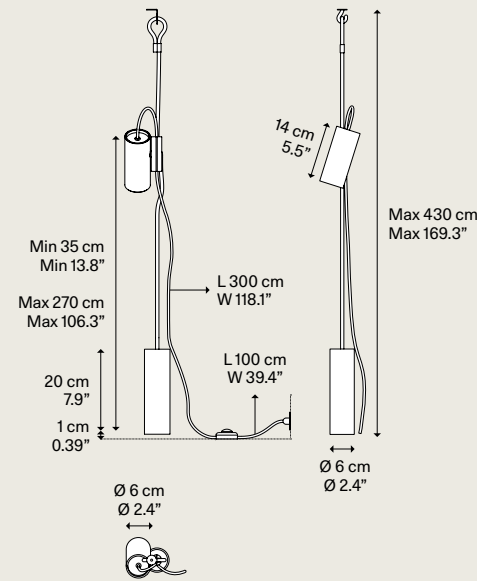

Light source Sorgente luminosa

GU10 Par 16 LED
» 1 x 10 W II
W/L max 9 cm
W/L max 3.54"

Bulb and dimmer
not included
Lampadina e dimmer
non inclusi

Light source Sorgente luminosa

GU10 Par 16 LED
» 1 x 10 W II
W/L max 9 cm
W/L max 3.54"

Bulb and dimmer
not included
Lampadina e dimmer
non inclusi

Metal structure Montatura in metallo

● Matte Black
Nero Opaco

Description Descrizione

Additional kit
max 2 spotlights
Kit aggiuntivo
max 2 spotlights

Rope Corda

● Silver
Argento

● Gold
Oro

● Yellow
Giallo

Code Codice

17371 4100

17371 5000

17371 5100

Metal structure Montatura in metallo

● Matte Black
Nero Opaco

Code Codice

17371K 2000

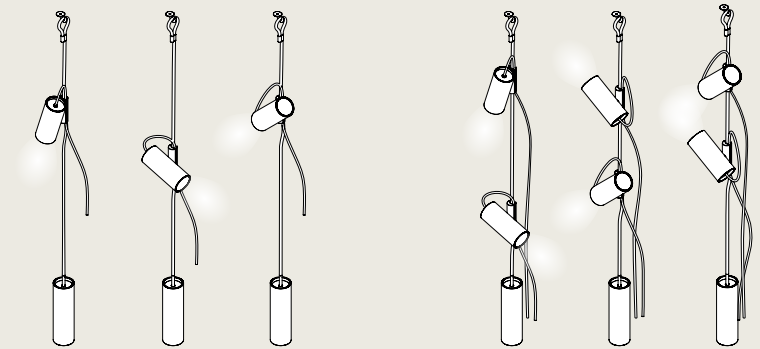

Adjustable light Luce orientabile

Net weight/ Peso netto: 1.750 kg

Pack/Colli: 1

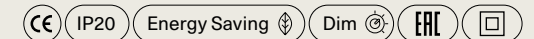

Tidal

Tidal is a ring-shaped ceiling lamp that evokes the motion of the tide and celestial bodies. Its fluid and oval design mimics wave movements and tidal changes, with one side wider than the other, appearing differently to the viewer depending on their position under the lamp. The die-cast aluminium body projects light up and down at the same time. The ring discreetly hides all the technical elements inside the design, enhancing the object's aesthetic value. Measuring 60 cm, *Tidal* is available in three matte finishes: white, suited to minimalist interiors, and terra and champagne, which offer a more decorative touch for embellishing spaces with their warm and elegant tones.

Tidal è una lampada da soffitto a forma di anello che rimanda all'effetto del moto della marea e ai corpi celesti. Il suo design fluido e ovale imita il movimento delle onde e il cambiamento dettato dalla marea, con un lato più largo dell'altro, che appare diverso all'utente a seconda della sua posizione nel guardare la lampada da sotto. La scocca del corpo lampada è realizzata in pressofusione di alluminio, proietta contemporaneamente la luce sia verso il basso che verso l'alto. L'anello nasconde discretamente tutti gli elementi tecnici all'interno, enfatizzando così il valore estetico dell'oggetto. Con una dimensione di 60 cm, *Tidal* è disponibile in tre finiture opache, bianco, terra o in champagne. Mentre il bianco si adatta a interni minimalisti, le tonalità terra e champagne offrono un tocco più decorativo, arricchendo gli spazi con i loro toni caldi ed eleganti.

Ceiling lamp

Tidal, FINISHES Matte Champagne,
Matte White and Terra

Tidal, *design by* Needs Studio, 2023





Tidal, FINISH Terra

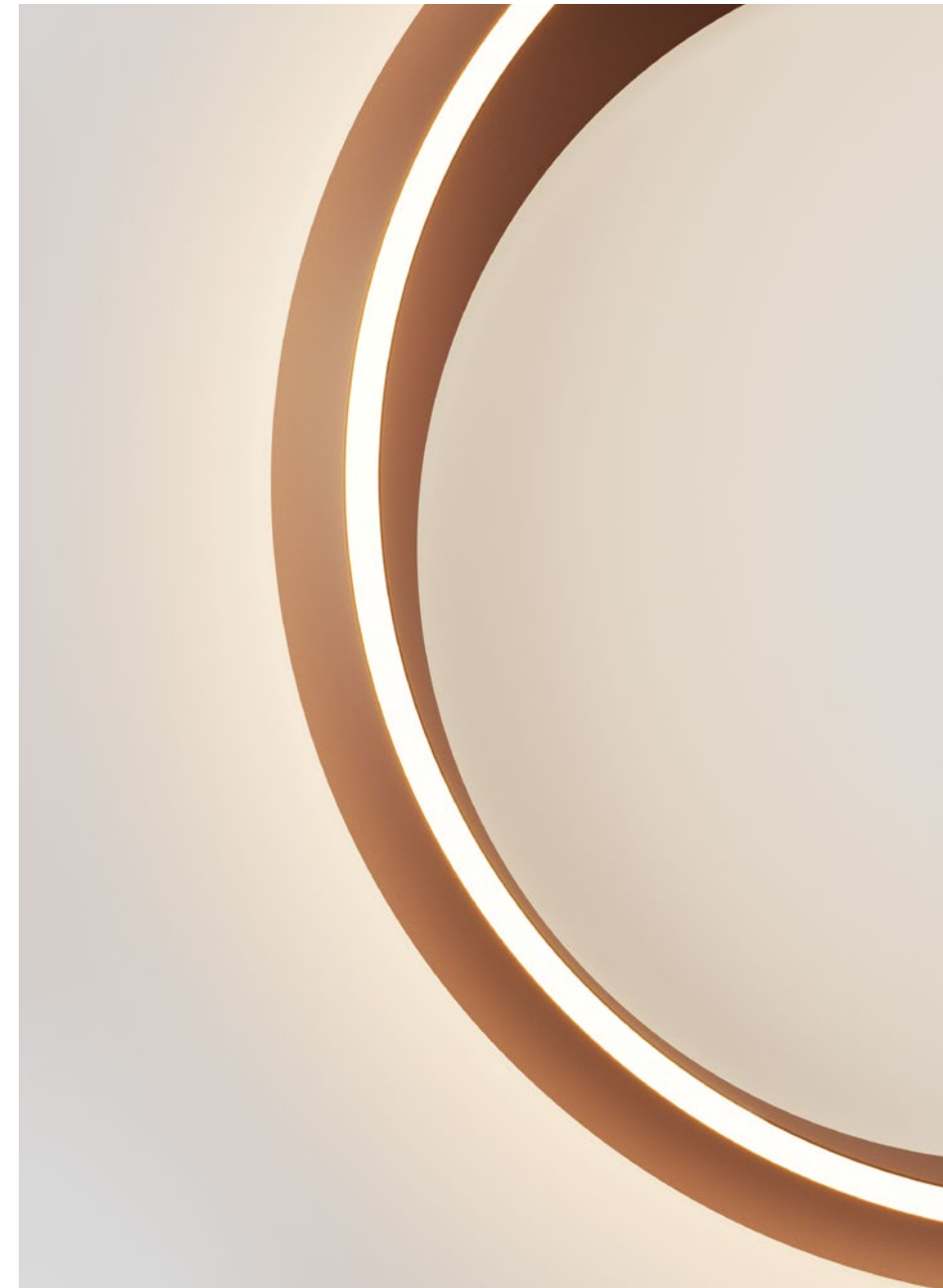

Tidal, main downward light framed by the geometry of the shells



Tidal, FINISH Matte White

Tidal,
FINISH Matte White





Tidal,
FINISH Matte Champagne



1



2

1, 2–Tidal relates to the ceiling thanks to a continuous glow in and outwards

Tidal est un plafonnier en forme d'anneau qui évoque le mouvement de la marée et des corps célestes. Son design fluide et ovale évoque le mouvement des vagues et le changement rythmé par la marée, avec un côté plus large que l'autre, qui apparaît différent selon le point où se trouve l'utilisateur lorsqu'il regarde la lampe par dessous. La coque du corps de la lampe, en aluminium moulé sous pression, projette simultanément la lumière vers le bas et vers le haut. L'anneau dissimule discrètement tous les éléments techniques et souligne ainsi la valeur esthétique de l'objet. Dans sa dimension de 60 cm, *Tidal* est disponible en trois finitions mates : blanc, terre ou champagne. Le blanc épouse parfaitement les intérieurs minimalistes, alors que les tonalités terre et champagne se proposent dans une touche plus décorative, enrichissant les espaces de leurs nuances chaudes et élégantes. ● FR

Tidal ist eine Deckenleuchte in Form eines Ringes, die auf den Effekt der Bewegung der Gezeiten und der Himmelskörper verweist. Ihr harmonisches und ovales Design ahmt die Bewegung der Wellen und den von den Gezeiten diktierten Wechsel nach, wobei eine Seite breiter als die andere ist und dem Benutzenden je nach seiner Position, beim Betrachten der Leuchte von unten, unterschiedlich erscheint. Der Körper der Leuchte, gefertigt aus Aluminiumdruckguss, projiziert das Licht gleichzeitig nach unten und nach oben. Der Ring verbirgt diskret alle technischen Elemente im Inneren und unterstreicht so den ästhetischen Wert des Objekts. Mit einer Abmessung von 60 cm ist *Tidal* in drei satinierten Ausführungen erhältlich: Weiß, Terra oder Champagner. Während Weiß zu minimalistischen Inneneinrichtungen passt, bieten die Farbtöne Terra und Champagner einen dekorativeren Touch und bereichern die Räume mit ihren warmen und eleganten Tönen. ● DE

Tidal es una lámpara de techo con forma de anillo que evoca el efecto del movimiento de la marea y los cuerpos celestes. Su diseño fluido y ovalado imita el movimiento de las olas y el cambio que dicta la marea, con un lado más ancho que otro que el usuario ve diferente dependiendo de su posición a la hora de mirar la lámpara desde abajo. El armazón del cuerpo de la lámpara de aluminio moldeado a presión proyecta simultáneamente la luz tanto hacia abajo como hacia arriba. El anillo oculta discretamente todos los elementos técnicos en su interior y de esta forma enfatiza el valor estético del objeto. Con un tamaño de 60 cm, *Tidal* está disponible en tres acabados mate, blanco, tierra o champán. Mientras que el blanco se adapta a interiores minimalistas, los tonos tierra y champán aportan un toque más decorativo y enriquecen los espacios con sus tonos cálidos y elegantes. ● ES

Tidal - это потолочный светильник в форме кольца, воссоздающий эффект движения прилива и небесных тел. Его струящаяся и овальная форма имитирует движения волн и изменения, создаваемые приливом, с одной более широкой стороной, которая меняется в зависимости от положения смотрящего на лампу снизу. Корпус светильника выполнен из литого под давлением алюминия, он одновременно проецирует свет в направлении вниз и вверх. Кольцо скрывает все технические компоненты внутри, подчеркивая эстетическую красоту предмета. Размером 60 см, *Tidal* выпускается в трех вариантах матовой отделки, белого цвета, цвета «terra» или «champagne». Белый прекрасно сочетается с минималистским интерьером, а тональности «terra» и «champagne» предлагают более декоративный стиль, обогащая пространство теплыми и элегантными тонами. ● RU

Tidal 是一款指射潮汐与天体运动效果的环形吸顶灯。它的椭圆形流体设计模仿海浪的运动与潮汐引起的变化，一侧较另一侧更宽，从下方看灯体时会根据用户所在位置而显示有所不同。灯体外壳由压铸铝制成，可同时间向下和向上投射光线。圆环将所有技术元件谨慎隐藏在内部，从而彰显了这款灯品的美学价值。以其60厘米的尺寸，*Tidal*提供白色、大地色或香槟色这三种哑光饰面。虽然白色适宜极简主义的内饰，但大地色和香槟色的色调更具装饰性，以其温暖优雅的色调使空间得以丰富。● ZH

Visit website:



Tidal, design by Needs Studio, 2023

Ceiling lamp

Tidal NEW

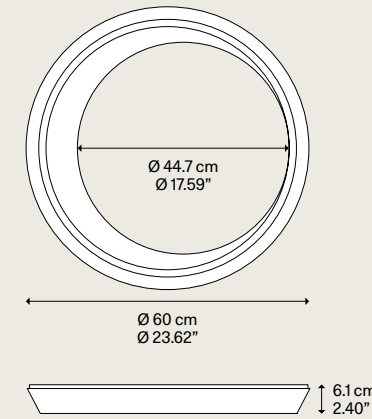

Light source Sorgente luminosa

LED
 ↘ 2700 K
 ↘ 23.4 W / 4680 lm
 ↘ 350 mA
 ↘ CRI 90
 ↘ MacAdam 3-Step

or

LED
 ↘ 3000 K
 ↘ 23.4 W / 4700 lm
 ↘ 350 mA
 ↘ CRI 90
 ↘ MacAdam 3-Step

LED and driver included
 LED e driver inclusi

Metal structure Montatura in metallo

Matte White – 9010
 Bianco Opaco – 9010

Code
Codice

19930 1027

Matte Champagne
 Champagne Opaco

19930 4527

Terra
 Terra

19930 6727

Matte White – 9010
 Bianco Opaco – 9010

19930 1030

Matte Champagne
 Champagne Opaco

19930 4530

Terra
 Terra

19930 6730

Net weight/Peso netto: 3.5 kg

Pack/Colli: 1

Energy class/Classe energetica: B

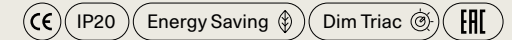

Ecodesign regulation ► pag. 444-445
 Regolamento di Ecodesign ► pag. 444-445

Tidal » Ceiling lamp NEW LAMP



Nautilus, Nautilus Mini

Strong design and leading-edge technology come together in this family of lamps characterised by a convex lens that projects the LED light wherever its needed or most preferred, for a truly efficient and personalised result. Versatile and dynamic, either on the wall or ceiling in a variety of versions and finishes, Nautilus lamps satisfy a full range of lighting needs, whether functional or purely decorative, in both residential and professional contexts.

Design deciso e tecnologia di punta si fondono in questa famiglia di lampade caratterizzate da una lente convessa che proietta la luce a LED dove serve o dove piace di più, per un risultato di efficienza e personalizzazione. Versatili e dinamiche, a parete o a soffitto, in diverse versioni e finiture, le lampade Nautilus soddisfano innumerevoli esigenze di illuminazione, dalle più funzionali a quelle particolarmente decorative, sia in ambito residenziale che professionale.

Wall lamp, Ceiling lamp

Nautilus and Nautilus Spot,
FINISH Chrome

Nautilus, *design by* Andrea Tosetto, 2017/2020



Nautilus,
FINISH Matte White

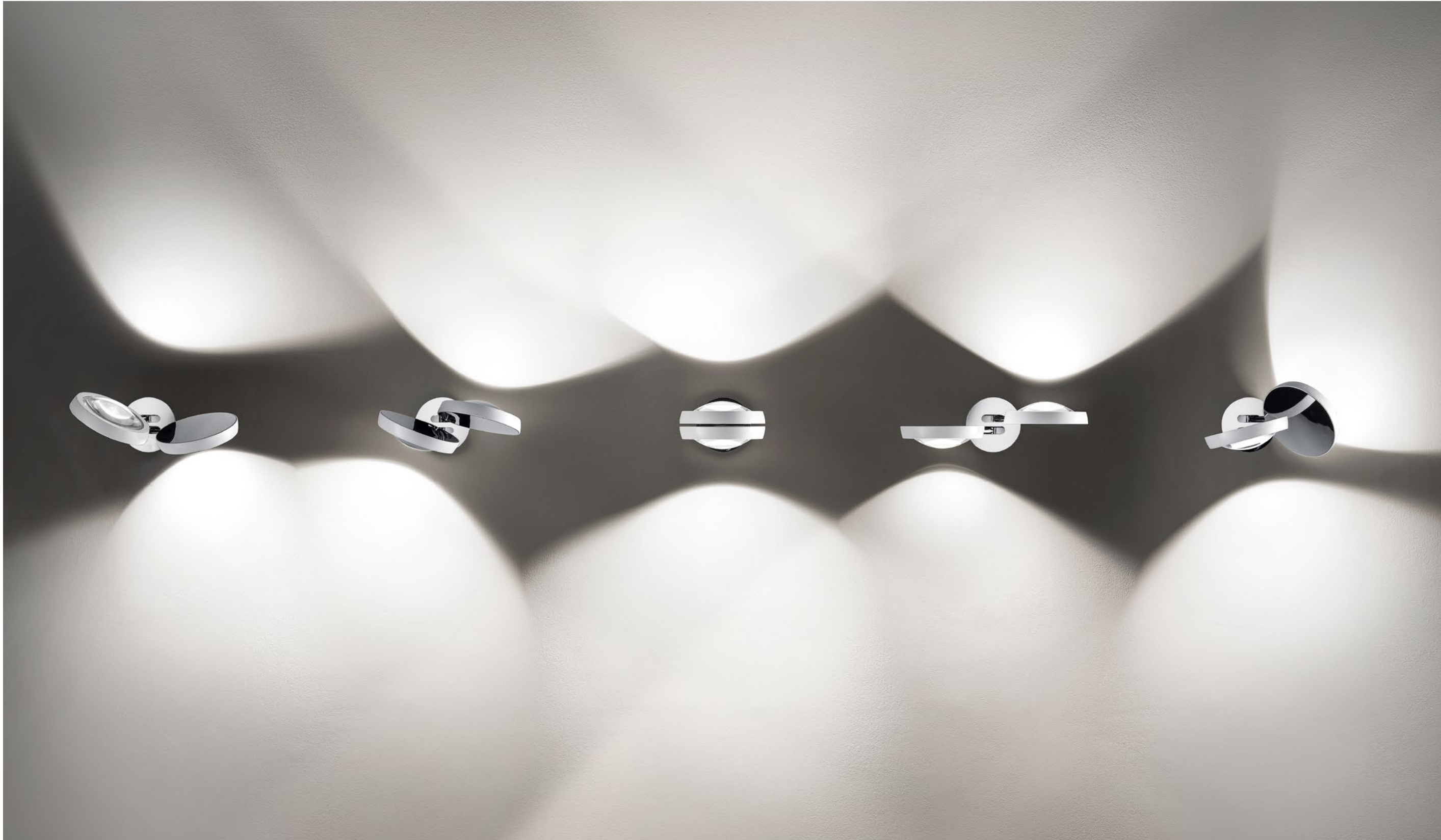



1, 2

3, 4

1/4–Nautilus,
FINISHES Chrome, Matte Champagne,
Matte Black and Matte White



Nautilus, FINISH Matte White



Nautilus, FINISH Matte White



1–Nautilus,
FINISH Matte White

2–Nautilus,
FINISH Matte Black



Nautilus Spot, FINISHES Matte Champagne, Chrome and Matte Black

Nautilus and Nautilus Spot,
FINISH Matte Black





Nautilus Mini, FINISH Matte Champagne

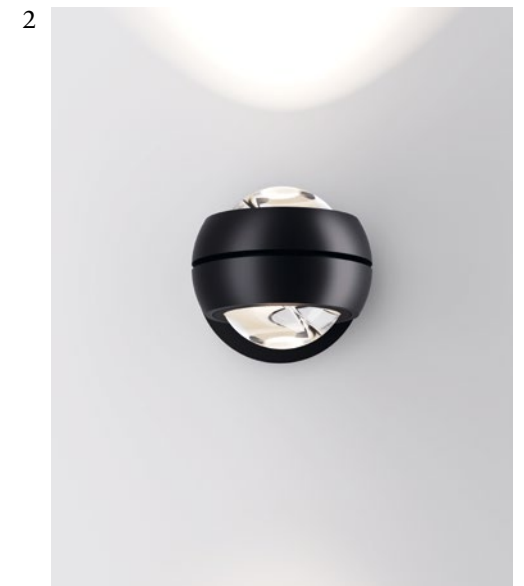

1/3–Nautilus Mini, FINISH Matte White,
Matte Black and Matte Champagne

Un design impeccable et une technologie de pointe fusionnent pour cette famille de lampes caractérisées par un verre convexe qui dirige la lumière à LED où il le faut et où vous le souhaitez le plus, pour un résultat efficace et personnalisé. Polyvalentes et dynamiques, appliques ou plafonniers, en différentes versions et finitions, les lampes Nautilus répondent à d'innombrables besoins d'éclairage, des plus fonctionnels à ceux particulièrement décoratifs, aussi bien dans le domaine résidentiel que professionnel. ● FR

Entschlossenes Design und Spitzentechnologie verschmelzen in dieser Leuchtenfamilie miteinander. Dabei ist letztere durch eine konvexe Linse gekennzeichnet, die LED-Licht dorthin strahlt, wo es notwendig ist oder am besten gefällt. So entsteht ein effizientes, personalisiertes Ergebnis. Vielseitig und dynamisch entsprechen die Wand- oder Deckenleuchten Nautilus in verschiedenen Versionen und Ausführungen zahlreichen Bedürfnissen betreffend die Beleuchtung nach - von besonders funktionell bis hin zu besonders dekorativ, sowohl im Wohnbereich wie auch im beruflichen Umfeld. ● DE

El diseño decisivo y la tecnología de vanguardia se unen en esta familia de lámparas caracterizada por una lente convexa que proyecta la luz LED donde se necesita o donde más gusta, para un resultado de eficiencia y personalización. Versátiles y dinámicas, de pared o de techo, en diferentes versiones y acabados, las lámparas Nautilus satisfacen innumerables necesidades de iluminación, desde las más funcionales hasta las más decorativas, tanto en entornos residenciales como profesionales. ● ES

Чистый дизайн и передовые технологии сочетаются в этом семействе светильников, характеризующихся выпуклой линзой, которая проецирует свет лампы LED туда, где это необходимо или где вам больше нравится, обеспечивая эффективность и персонализацию. Светильники Nautilus, универсальные и динамичные, настенные или потолочные, в разных вариантах исполнения и отделки, удовлетворяют бесчисленные потребности светового оформления, от самого функционального до особо декоративного, как в жилых, так и в офисных помещениях. ● RU

决定性的设计与最先进的技术相结合，凸透镜是该家族系列灯具的特征，该凸透镜可将LED光投射到需要的地方或是您最喜欢的地方，以提高效率和定制化。Nautilus灯具有多功能性和动态性，可以壁式安装或吸顶安装，具有不同的版本和颜色，可以满足无数的照明需求，从最实用的功能到特别装饰性的功能，无论是在住宅还是在专业环境中。● ZH

Visit website:



Nautilus ▾ Wall lamp



Nautilus Mini ▾ Wall lamp

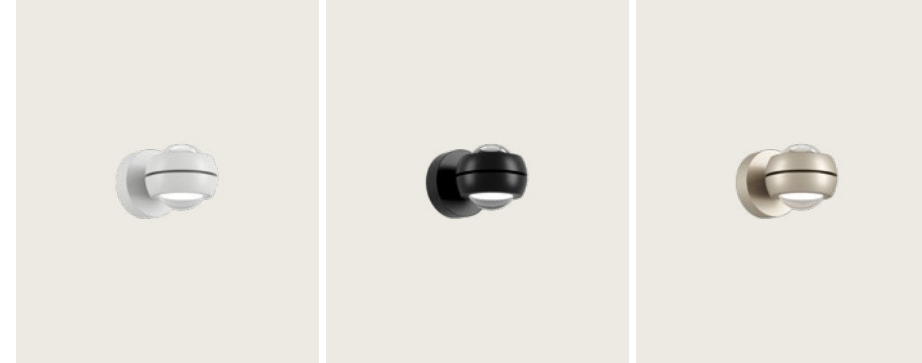

Nautilus ▾ Ceiling lamp

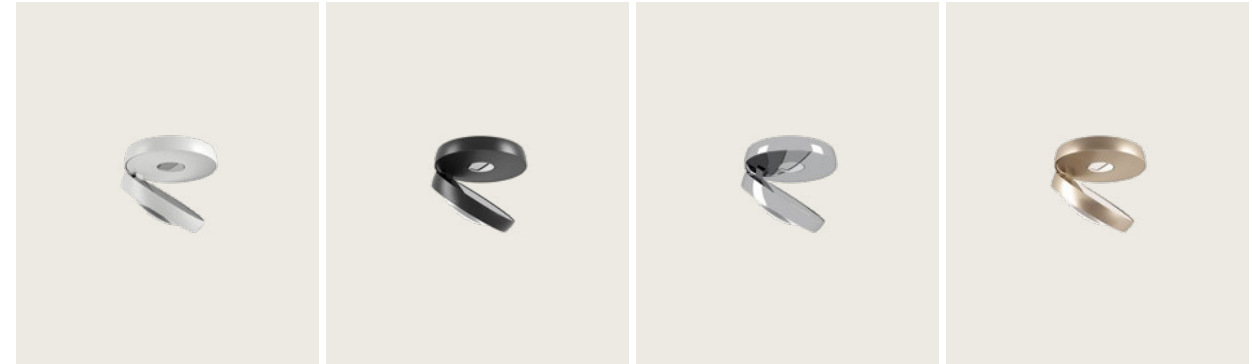

Nautilus Spot ▾ Ceiling lamp

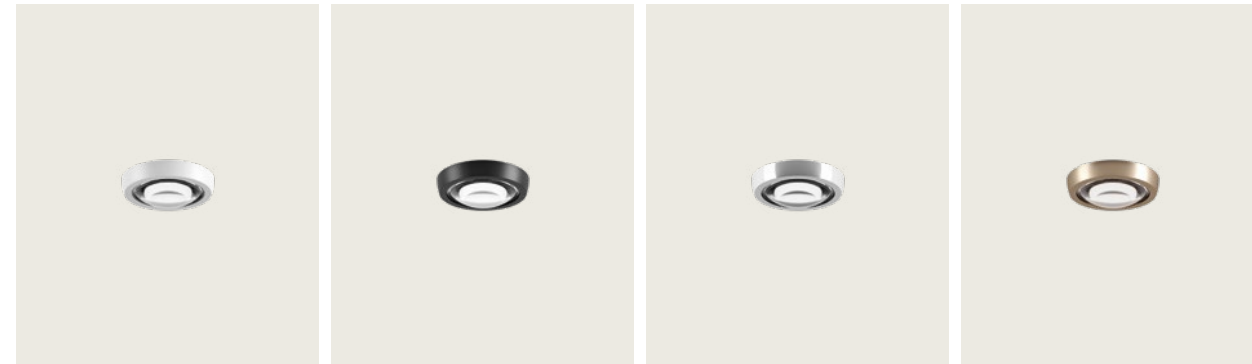

Nautilus, design by Andrea Tosetto, 2017

Wall lamp

Nautilus

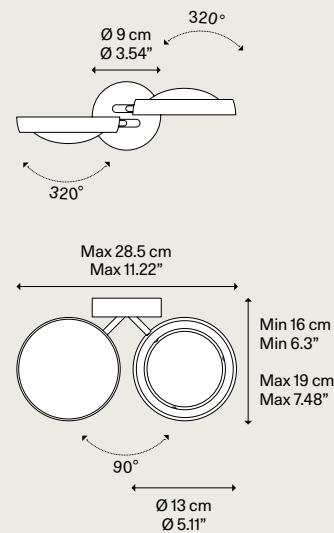

Light source Sorgente luminosa	Metal structure Montatura in metallo	Metal diffuser Diffusore in metallo	Code Codice
LED ↘ 2700 K ↘ 2 × 12 W/1990 lm ↘ 220-240 V ↘ CRI 90 ↘ MacAdam 3-Step	Matte White - 9010 Bianco Opaco - 9010	Matte White - 9010 Bianco Opaco - 9010	16550 1927
	Matte Black - 9005 Nero Opaco - 9005	Matte Black - 9005 Nero Opaco - 9005	16550 2927
	Chrome Cromo	Chrome Cromo	16550 4027
or	Matte Champagne Champagne Opaco	Matte Champagne Champagne Opaco	16550 4927
	Matte White - 9010 Bianco Opaco - 9010	Matte White - 9010 Bianco Opaco - 9010	16550 1930
	Matte Black - 9005 Nero Opaco - 9005	Matte Black - 9005 Nero Opaco - 9005	16550 2930
LED ↘ 3000 K ↘ 2 × 12 W/2170 lm ↘ 220-240 V ↘ CRI 90 ↘ MacAdam 3-Step	Chrome Cromo	Chrome Cromo	16550 4030
	Matte Champagne Champagne Opaco	Matte Champagne Champagne Opaco	16550 4930
	LED included LED incluso		

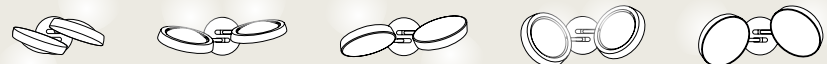

Adjustable light
Luce orientabile

Net weight/Peso netto: 1.15 kg

Pack/Colli: 1

Energy class/Classe energetica: F

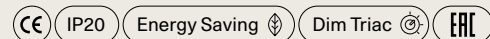

Wall lamp

Nautilus Mini

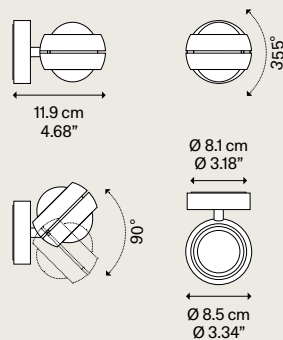

Light source Sorgente luminosa	Metal structure Montatura in metallo	Code Codice
LED ↘ 2700 K ↘ 2 × 6 W/950 lm ↘ 220-240 V ↘ CRI 90 ↘ MacAdam 3-Step	Matte White - 9010 Bianco Opaco - 9010	16552 1027
	Matte Black - 9005 Nero Opaco - 9005	16552 2027
	Matte Champagne Champagne Opaco	16552 4527
or	Matte White - 9010 Bianco Opaco - 9010	16552 1030
	Matte Black - 9005 Nero Opaco - 9005	16552 2030
	Matte Champagne Champagne Opaco	16552 4530
LED included LED incluso		



Adjustable light
Luce orientabile

Net weight/Peso netto: 0.75 kg

Pack/Colli: 1

Energy class/Classe energetica: G

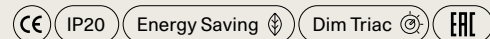

Ecodesign regulation ► pag. 444-445
Regolamento di Ecodesign ► pag. 444-445

LED sources with direct power supply to the AC line voltage - driver not required. Dimmable with phase cut dimmer.

LED con alimentazione diretta a tensione di rete - non necessita di driver. Dimmerabile con varialuce a taglio di fase.

Nautilus, design by Andrea Tosetto, 2017

Ceiling lamp

Nautilus

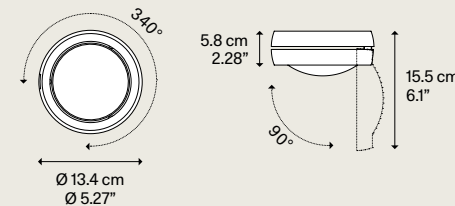

Light source Sorgente luminosa	Metal structure Montatura in metallo	Code Codice
LED ↘ 2700 K ↘ 12 W/995 lm ↘ 220-240 V ↘ CRI 90 ↘ MacAdam 3-Step	Matte White - 9010 Bianco Opaco - 9010	16530 1027
	Matte Black - 9005 Nero Opaco - 9005	16530 2027
	Chrome Cromo	16530 4027
or	Matte Champagne Champagne Opaco	16530 4527
	Matte White - 9010 Bianco Opaco - 9010	16530 1030
	Matte Black - 9005 Nero Opaco - 9005	16530 2030
LED ↘ 3000 K ↘ 12 W/1085 lm ↘ 220-240 V ↘ CRI 90 ↘ MacAdam 3-Step	Chrome Cromo	16530 4030
	Matte Champagne Champagne Opaco	16530 4530
	LED included LED incluso	



Adjustable light
Luce orientabile

Net weight/Peso netto: 1.10 kg

Pack/Colli: 1

Energy class/Classe energetica: F

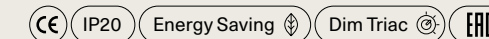

Nautilus Spot, design by Andrea Tosetto, 2020

Ceiling lamp

Nautilus Spot

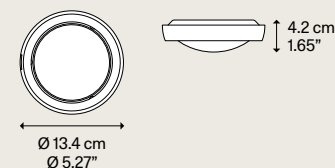

Light source Sorgente luminosa	Metal structure Montatura in metallo	Code Codice
LED ↘ 2700 K ↘ 10 W/945 lm ↘ 220-240 V ↘ CRI 90 ↘ MacAdam 3-Step	Matte White - 9010 Bianco Opaco - 9010	16560 1027
	Matte Black - 9005 Nero Opaco - 9005	16560 2027
	Chrome Cromo	16560 4027
or	Matte Champagne Champagne Opaco	16560 4527
	Matte White - 9010 Bianco Opaco - 9010	16560 1030
	Matte Black - 9005 Nero Opaco - 9005	16560 2030
LED ↘ 3000 K ↘ 10 W/950 lm ↘ 220-240 V ↘ CRI 90 ↘ MacAdam 3-Step	Chrome Cromo	16560 4030
	Matte Champagne Champagne Opaco	16560 4530
	LED included LED incluso	

Adjustable light
Luce orientabile

Net weight/Peso netto: 0.56 kg

Pack/Colli: 1

Energy class/Classe energetica: F

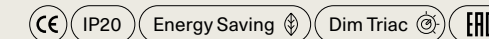

Ecodesign regulation ► pag. 444-445
Regolamento di Ecodesign ► pag. 444-445

LED sources with direct power supply to the AC line voltage - driver not required. Dimmable with phase cut dimmer.

LED con alimentazione diretta a tensione di rete - non necessita di driver. Dimmerabile con varialuce a taglio di fase.

Aile

The new Aile aluminium wall lamp features a simple and dynamic design reminiscing the *aileron* of sport cars, after which it has been named. Aile's compact size, sleek design, powerful light output with respect to its dimensions and four rich finishes offer a complete lighting solution even for more intimate settings.

Aile, nuova lampada da parete in alluminio, presenta un design semplice e dinamico, proprio come l'alettone delle auto sportive, *aileron* in inglese, da cui prende il nome. La compattezza, il design elegante, la forte capacità di emissione di luce rispetto alle dimensioni e le quattro ricche finiture rendono Aile una soluzione perfetta anche per illuminare ambienti raccolti.

Wall lamp

Aile, FINISH Lacquer Red

Aile, *design by* Luca Nichetto, 2021





1–Aile, FINISH Lacquer Red
2–Aile, FINISH Matte Black

Aile, FINISH Lacquer Red



Aile, FINISH Matte White

Aile, FINISH Champagne

Légère applique en aluminium, la nouvelle Aile présente un design simple et dynamique rappelant l'aileron d'une voiture de sport dont le nom s'inspire. La taille compacte d'Aile, son design élégant, son rayonnement lumineux puissant par rapport aux dimensions et ses quatre riches finitions offrent une solution d'éclairage complète, même pour des espaces plus intimes. ●FR

Die neue Aile Aluminium-Wandleuchte zeichnet sich durch ein schlichtes Design mit einer dynamischen Form aus, die an das Querruder eines Sportwagens erinnert –aileron auf Englisch, nach dem sie benannt wurde. Ailes kompakte Größe, das schlanke Design und die starke Lichtleistung im Vergleich zur Fläche bieten eine komplette Beleuchtungslösung sogar für intimere Umgebungen. ●DE

Ligera lámpara de pared en aluminio, la nueva Aile presenta un diseño sencillo y dinámico que recuerda el alerón de un automóvil deportivo, aileron en inglés, que a su vez le da nombre. El tamaño compacto, el diseño elegante, la potente salida de luz con respecto a sus dimensiones y los cuatro ricos acabados hacen que Aile sea una solución de iluminación completa incluso para entornos más íntimos. ●ES

Новая настенная алюминиевая лампа Aile отличается простым дизайном и динамичной формой, напоминающей элероны спортивных автомобилей, «aileron» на английском, в честь которых она и получила свое название. Компактный размер, элегантный дизайн, мощная светоотдача, по сравнению с ее размерами, а также четыре варианта богатой отделки делают из Aile идеальное решение также для освещения более интимных уголков. ●RU

全新Aile铝制壁灯拥有简约大方且与动感十足的设计,令人联想至跑车的副翼,从而以此得名。Aile紧凑的尺寸、时尚的设计、相对其尺寸的强大光线输出以及四款丰富的饰面,为更多甚至私密的环境设置提供了一项完整的照明解决方案。●ZH

Visit website:



Aile, design by Luca Nichetto, 2021

Wall lamp

Aile

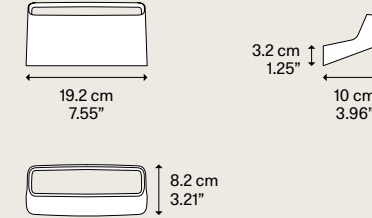

Light source Sorgente luminosa

LED
 ▸ 2700 K
 ▸ 2 x 8 W/1840 lm
 ▸ 220-240 V
 ▸ CRI 92
 ▸ MacAdam 3-Step

or

LED
 ▸ 3000 K
 ▸ 2 x 8 W/1960 lm
 ▸ 220-240 V
 ▸ CRI 92
 ▸ MacAdam 3-Step

LED included
 LED incluso

Metal structure Montatura in metallo

● Matte White – 9010
 Bianco Opaco – 9010

● Matte Black – 9005
 Nero Opaco – 9005

● Champagne
 Champagne

● Lacquer Red
 Rosso Lacca

● Matte White – 9010
 Bianco Opaco – 9010

● Matte Black – 9005
 Nero Opaco – 9005

● Champagne
 Champagne

● Lacquer Red
 Rosso Lacca

Code Codice

17550 1027

17550 2027

17550 4527

17550 6027

17550 1030

17550 2030

17550 4530

17550 6030

Net weight/Peso netto: 0.55 kg

Pack/Coll: 1

Energy class/Classe energetica: E



IP20

Energy Saving

Dim Triac



Ecodesign regulation ► pag. 444-445
 Regolamento di Ecodesign ► pag. 444-445

Aile ▾ Wall lamp

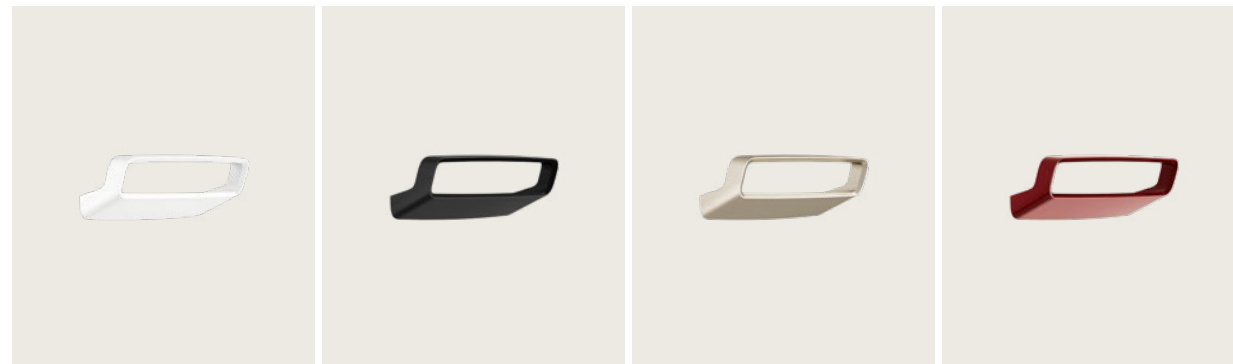

Puzzle Mega

Large geometric figures characterised by essential forms, which almost merge with the interior architecture when off, only to be surprisingly revealed as harmonies of light and shadow when lit. New matte finishes warm up the geometric panels of Puzzle Mega. Liquid paints that open new decorative possibilities, playing with harmonies and contrasts of colours and shapes.

Grandi figure geometriche dalle forme essenziali che quasi si fondono con l'architettura interna quando sono spente, per rivelare inaspettate armonie di luci e ombre una volta accese. Nuove finiture opache scaldano i pannelli geometrici di Puzzle Mega. Vernici liquide che aprono nuove possibilità decorative giocando con armonie e contrasti di colori e forme.

Wall lamp, Ceiling lamp

Puzzle Mega, FINISHES Matte
Red, Black and Taupe

Puzzle Mega, *design by* Studio Italia Design, 2019

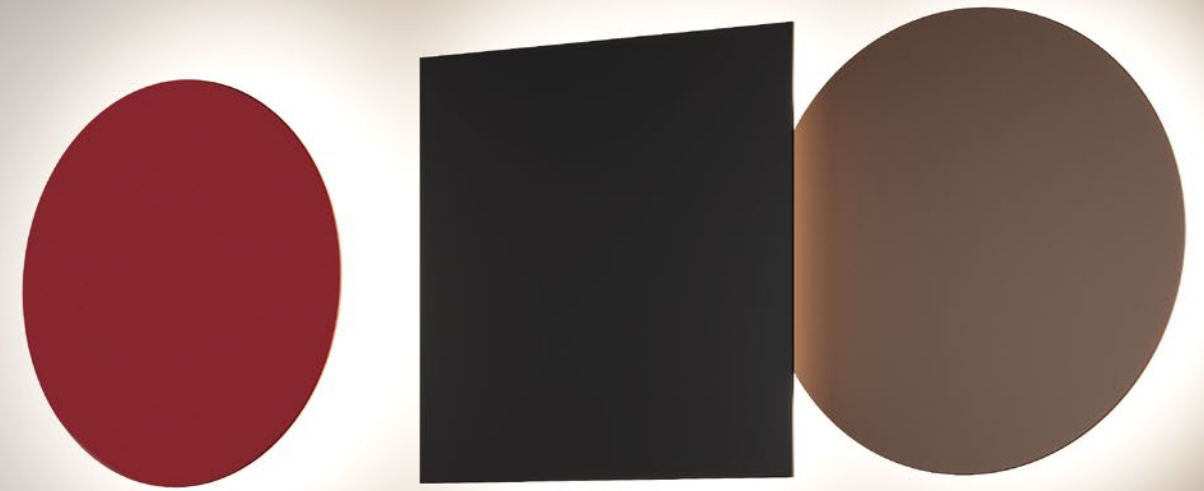

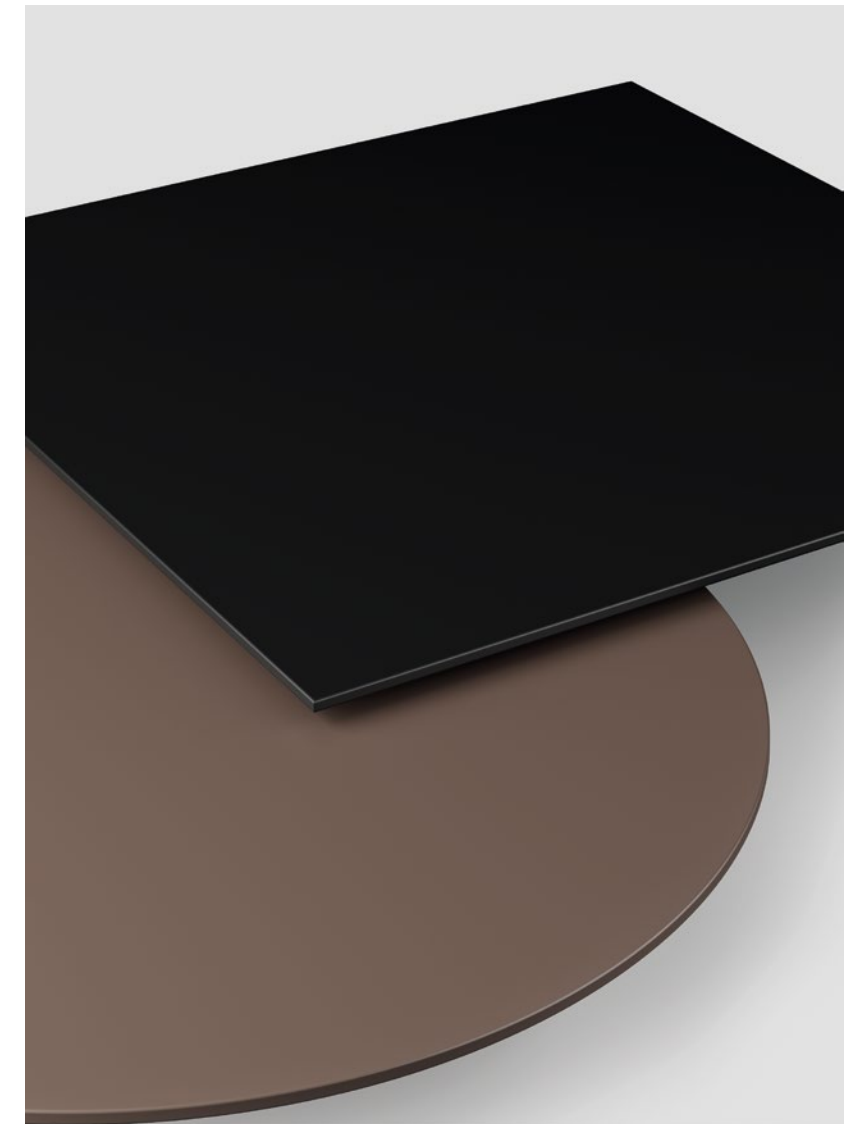

Puzzle Mega, FINISHES Matte Black and Taupe

Puzzle Mega, FINISHES Matte White, Taupe and Black

Puzzle Mega square large and round large,
FINISHES Matte Black and White



Puzzle Mega, FINISHES Matte White and Taupe



Puzzle Mega, FINISH Matte Red



Puzzle Mega round large and square large, FINISHES Matte Red and Taupe



Puzzle Mega compositions, FINISHES Matte White and Taupe

Grandes figures géométriques aux formes essentielles qui se fondent presque dans l'architecture interne lorsqu'elles sont éteintes, pour révéler d'inattendues harmonies de lumière et d'ombres une fois éclairées. Les nouvelles finitions mates rendent les panneaux géométriques de Puzzle Mega plus chaleureux. Vernis liquides qui offrent de nouvelles possibilités décoratives en jouant avec les harmonies et les contrastes de couleurs et de formes. ● FR

Große geometrische Figuren in einfacher Form, die ausgeschaltet mit der Innenarchitektur verschmelzen, um eingeschaltet eine unerwartete Harmonie aus Licht und Schatten entstehen zu lassen. Neue matte Ausführungen erwärmen die geometrischen Paneele von Puzzle Mega. Flüssiglacke, die durch das Spiel mit Harmonien und Kontrasten von Farben und Formen neue dekorative Möglichkeiten eröffnen. ● DE

Grandes figuras geométricas con formas esenciales que casi se mezclan con la arquitectura interior cuando se apagan, para revelar inesperadas armonías de luz y sombras una vez encendidas. Nuevos acabados mate calientan los paneles geométricos de Puzzle Mega. Pinturas líquidas que brindan nuevas posibilidades decorativas jugando con armonías y contrastes de colores y formas. ● ES

Крупные геометрические фигуры с простыми строгими формами, которые почти полностью сливаются с архитектурой интерьера, когда они выключены. Но стоит их включить, как вы увидите неожиданную и гармоничную игру света и тени. Новые матовые отделки согревают геометрические панели Puzzle Mega. Жидкие эмали, открывающие новые декоративные возможности, играя с гармонией и контрастами цветов и форм. ● RU

该灯具具有大型几何图形的基本形状，关闭时，几乎与内部架构融为一体，一旦打开，会发现意想不到的光影和谐。全新哑光饰面为Puzzle Mega的几何面板带来温暖。液体涂料通过色彩和形状的和谐与对比开辟了新的装饰可能性。● ZH

Visit website:



Puzzle Mega round small ▸ Wall lamp

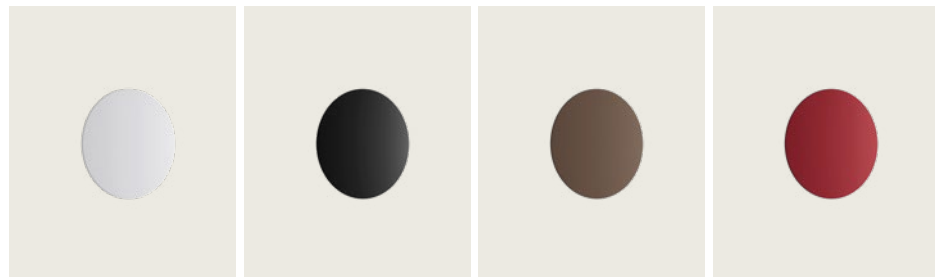

Puzzle Mega round large ▸ Wall lamp

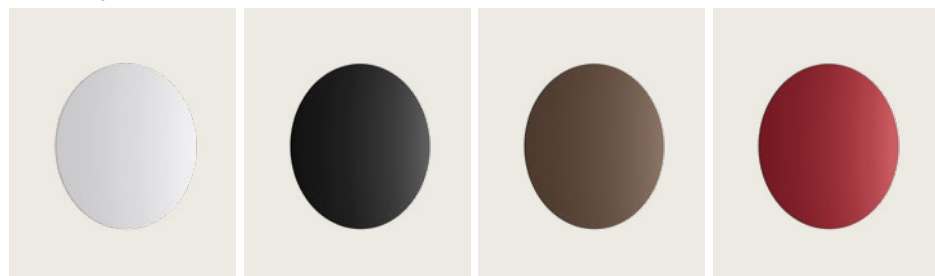

Puzzle Mega square small ▸ Wall lamp

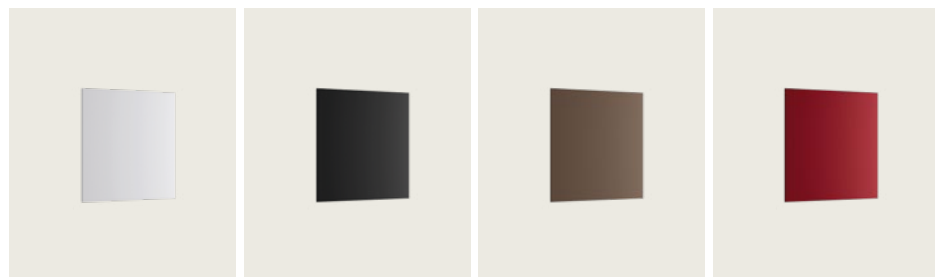

Puzzle Mega square large ▸ Wall lamp

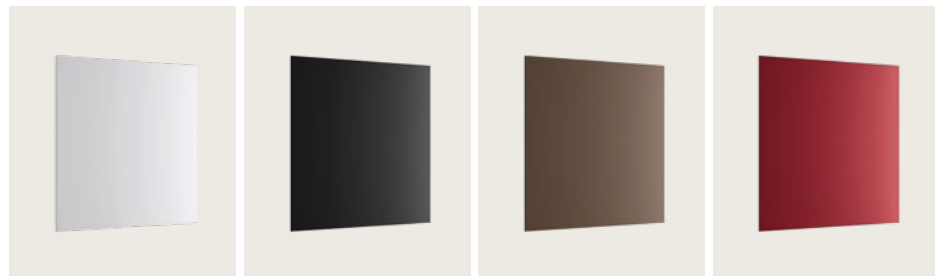

Puzzle Mega round small ▸ Ceiling lamp



Puzzle Mega round large ▸ Ceiling lamp



Puzzle Mega square small ▸ Ceiling lamp

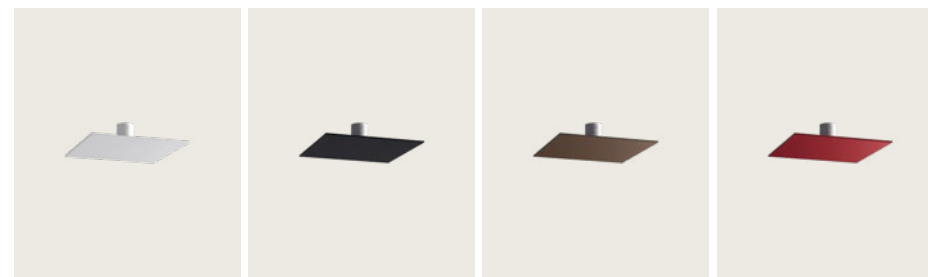

Puzzle Mega square large ▸ Ceiling lamp

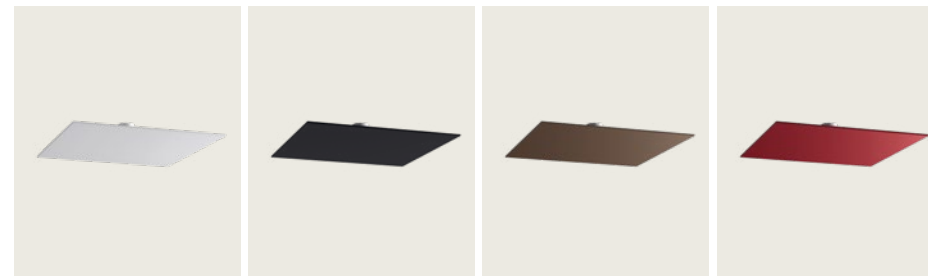

Puzzle Mega, design by Studio Italia Design, 2019

Wall lamp Ceiling lamp

Puzzle Mega round small

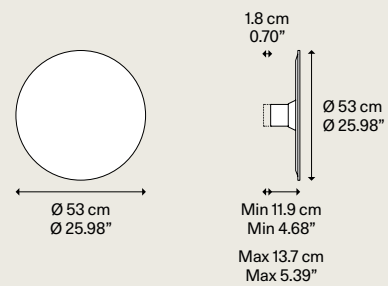

Light source Sorgente luminosa	Metal structure Montatura in metallo	MDF diffuser Diffusore in MDF	Code Codice
LED ↘ 2700 K ↘ 3 × 15 W/5250 lm ↘ 220-240 V ↘ CRI 92 ↘ MacAdam 3-Step	● Matte White - 9016 Bianco Opaco - 9016	● Matte White - 9016 Bianco Opaco - 9016	16741 1027
		● Matte Black - 9005 Nero Opaco - 9005	16741 2027
		● Taupe Grigio Caldo	16741 3927
LED ↘ 3000 K ↘ 3 × 15 W/5550 lm ↘ 220-240 V ↘ CRI 92 ↘ MacAdam 3-Step	● Matte White - 9016 Bianco Opaco - 9016	● Red Rosso	16741 6027
		● Matte White - 9016 Bianco Opaco - 9016	16741 1030
		● Matte Black - 9005 Nero Opaco - 9005	16741 2030
		● Taupe Grigio Caldo	16741 3930
		● Red Rosso	16741 6030
LED included LED incluso			

Net weight/Peso netto: 3.8 kg

Pack/Colli: 2

Energy class/Classe energetica: F

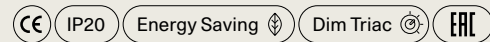

Puzzle Mega round large

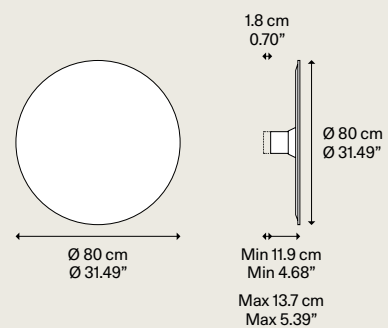

Light source Sorgente luminosa	Metal structure Montatura in metallo	MDF diffuser Diffusore in MDF	Code Codice
LED ↘ 2700 K ↘ 4 × 15 W/7000 lm ↘ 220-240 V ↘ CRI 92 ↘ MacAdam 3-Step	● Matte White - 9016 Bianco Opaco - 9016	● Matte White - 9016 Bianco Opaco - 9016	16744 1027
		● Matte Black - 9005 Nero Opaco - 9005	16744 2027
		● Taupe Grigio Caldo	16744 3927
LED ↘ 3000 K ↘ 4 × 15 W/7400 lm ↘ 220-240 V ↘ CRI 92 ↘ MacAdam 3-Step	● Matte White - 9016 Bianco Opaco - 9016	● Red Rosso	16744 6027
		● Matte White - 9016 Bianco Opaco - 9016	16744 1030
		● Matte Black - 9005 Nero Opaco - 9005	16744 2030
		● Taupe Grigio Caldo	16744 3930
		● Red Rosso	16744 6030
LED included LED incluso			

Net weight/Peso netto: 7.2 kg

Pack/Colli: 2

Energy class/Classe energetica: F

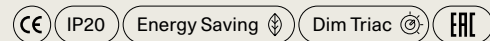

Ecodesign regulation ► pag. 444-445
Regolamento di Ecodesign ► pag. 444-445

► LED sources with direct power supply to the AC line voltage - driver not required. Dimmable with phase cut dimmer.
► You can connect up to 4 Puzzle Mega to each fixture directly connected to the power supply. You can also connect up to 3 additional fixtures to each of those for maximum total of 36 fixtures on a single power outlet.

► LED con alimentazione diretta a tensione di rete - non necessita di driver. Dimmerabile con varialuce a taglio di fase.
► Ad ogni Puzzle Mega connessa al punto di alimentazione elettrica possono esserne collegate altre 4. Ad ognuna di queste possono esserne collegate fino ad altre 3 e così via. Le lampade totali collegabili su un singolo punto di alimentazione sono 36.

Puzzle Mega, design by Studio Italia Design, 2019

Wall lamp Ceiling lamp

Puzzle Mega square small

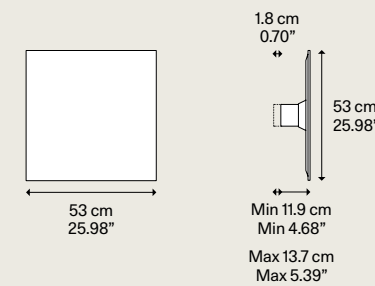

Light source Sorgente luminosa	Metal structure Montatura in metallo	MDF diffuser Diffusore in MDF	Code Codice
LED ↘ 2700 K ↘ 3 × 15 W/5250 lm ↘ 220-240 V ↘ CRI 92 ↘ MacAdam 3-Step	● Matte White - 9016 Bianco Opaco - 9016	● Matte White - 9016 Bianco Opaco - 9016	16742 1027
		● Matte Black - 9005 Nero Opaco - 9005	16742 2027
		● Taupe Grigio Caldo	16742 3927
LED ↘ 3000 K ↘ 3 × 15 W/5550 lm ↘ 220-240 V ↘ CRI 92 ↘ MacAdam 3-Step	● Matte White - 9016 Bianco Opaco - 9016	● Red Rosso	16742 6027
		● Matte White - 9016 Bianco Opaco - 9016	16742 1030
		● Matte Black - 9005 Nero Opaco - 9005	16742 2030
		● Taupe Grigio Caldo	16742 3930
		● Red Rosso	16742 6030
LED included LED incluso			

Net weight/Peso netto: 4.1 kg

Pack/Colli: 2

Energy class/Classe energetica: F

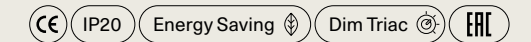

Puzzle Mega square large

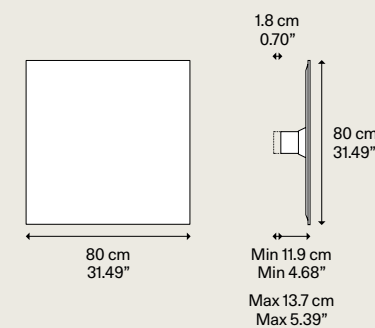

Light source Sorgente luminosa	Metal structure Montatura in metallo	MDF diffuser Diffusore in MDF	Code Codice
LED ↘ 2700 K ↘ 4 × 15 W/7000 lm ↘ 220-240 V ↘ CRI 92 ↘ MacAdam 3-Step	● Matte White - 9016 Bianco Opaco - 9016	● Matte White - 9016 Bianco Opaco - 9016	16745 1027
		● Matte Black - 9005 Nero Opaco - 9005	16745 2027
		● Taupe Grigio Caldo	16745 3927
LED ↘ 3000 K ↘ 4 × 15 W/7400 lm ↘ 220-240 V ↘ CRI 92 ↘ MacAdam 3-Step	● Matte White - 9016 Bianco Opaco - 9016	● Red Rosso	16745 6027
		● Matte White - 9016 Bianco Opaco - 9016	16745 1030
		● Matte Black - 9005 Nero Opaco - 9005	16745 2030
		● Taupe Grigio Caldo	16745 3930
		● Red Rosso	16745 6030
LED included LED incluso			

Net weight/Peso netto: 8.8 kg

Pack/Colli: 2

Energy class/Classe energetica: F

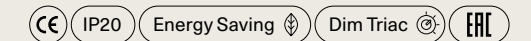

Ecodesign regulation ► pag. 444-445
Regolamento di Ecodesign ► pag. 444-445

► LED sources with direct power supply to the AC line voltage - driver not required. Dimmable with phase cut dimmer.
► You can connect up to 4 Puzzle Mega to each fixture directly connected to the power supply. You can also connect up to 3 additional fixtures to each of those for maximum total of 36 fixtures on a single power outlet.

► LED con alimentazione diretta a tensione di rete - non necessita di driver. Dimmerabile con varialuce a taglio di fase.
► Ad ogni Puzzle Mega connessa al punto di alimentazione elettrica possono esserne collegate altre 4. Ad ognuna di queste possono esserne collegate fino ad altre 3 e così via. Le lampade totali collegabili su un singolo punto di alimentazione sono 36.

Puzzle Mega, design by Studio Italia Design, 2019

Accessory

Puzzle Mega extension

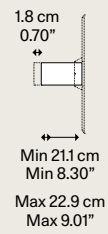

Description Descrizione

Extension optional
Estensione opzionale

To be used to widen
the light beam in case
of ceiling installation

Da utilizzare per ampliare
il fascio luminoso in
caso di installazione a
soffitto

Metal structure Montatura in metallo

Matte White - 9016
Bianco Opaco - 9016

Code Codice

16799 A200

Net weight/Peso netto: 0.86 kg

Pack/Colli: 1



Accessory connector



Description Descrizione

Connection
Collegamento

To be used to connect
the fixtures together in
the compositions

Da utilizzare per
collegare le lampade tra
loro nelle composizioni

Code Codice

16799 A100

Net weight/Peso netto: 0.10 kg

Pack/Colli: 1



► LED sources with direct power supply to the AC line voltage - driver not required. Dimmable with phase cut dimmer.
► You can connect up to 4 Puzzle Mega to each fixture directly connected to the power supply. You can also connect up to 3 additional fixtures to each of those for maximum total of 36 fixtures on a single power outlet.

► LED con alimentazione diretta a tensione di rete - non necessita di driver. Dimmerabile con varialuce a taglio di fase.
► Ad ogni Puzzle Mega connessa al punto di alimentazione elettrica possono esserne collegate altre 4. Ad ognuna di queste possono esserne collegate fino ad altre 3 e così via. Le lampade totali collegabili su un singolo punto di alimentazione sono 36.

Puzzle Mega, design by Studio Italia Design, 2019

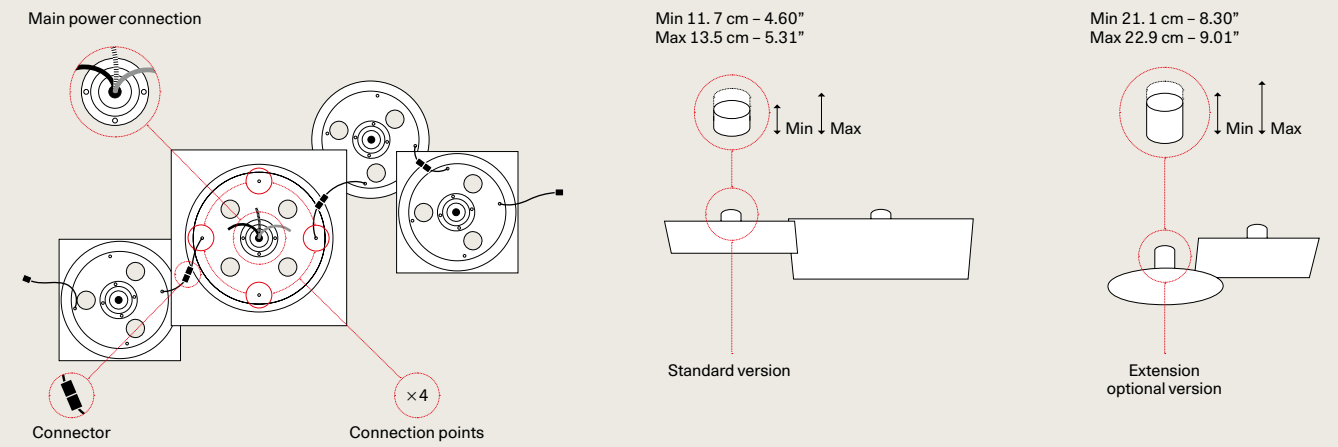

Puzzle Round

With its soft shapes, flexible joints and LED light source, Puzzle Round can be adjusted at will to create striking light effects on walls and ceilings. The unobtrusive aesthetics and the four available finishes, now including Champagne, make it perfect for the most varied living contexts.

Con le sue forme morbide, i giunti flessibili e la sorgente luminosa a LED, Puzzle Round può essere regolata a piacimento per creare suggestivi giochi di luce su pareti e soffitti. L'estetica discreta e le quattro finiture disponibili, ora anche Champagne, la rendono perfetta per i più svariati contesti abitativi.

Wall lamp, Ceiling lamp

Puzzle Round single and double,
FINISH Champagne

Puzzle Round, *design by* Studio Italia Design, 2016

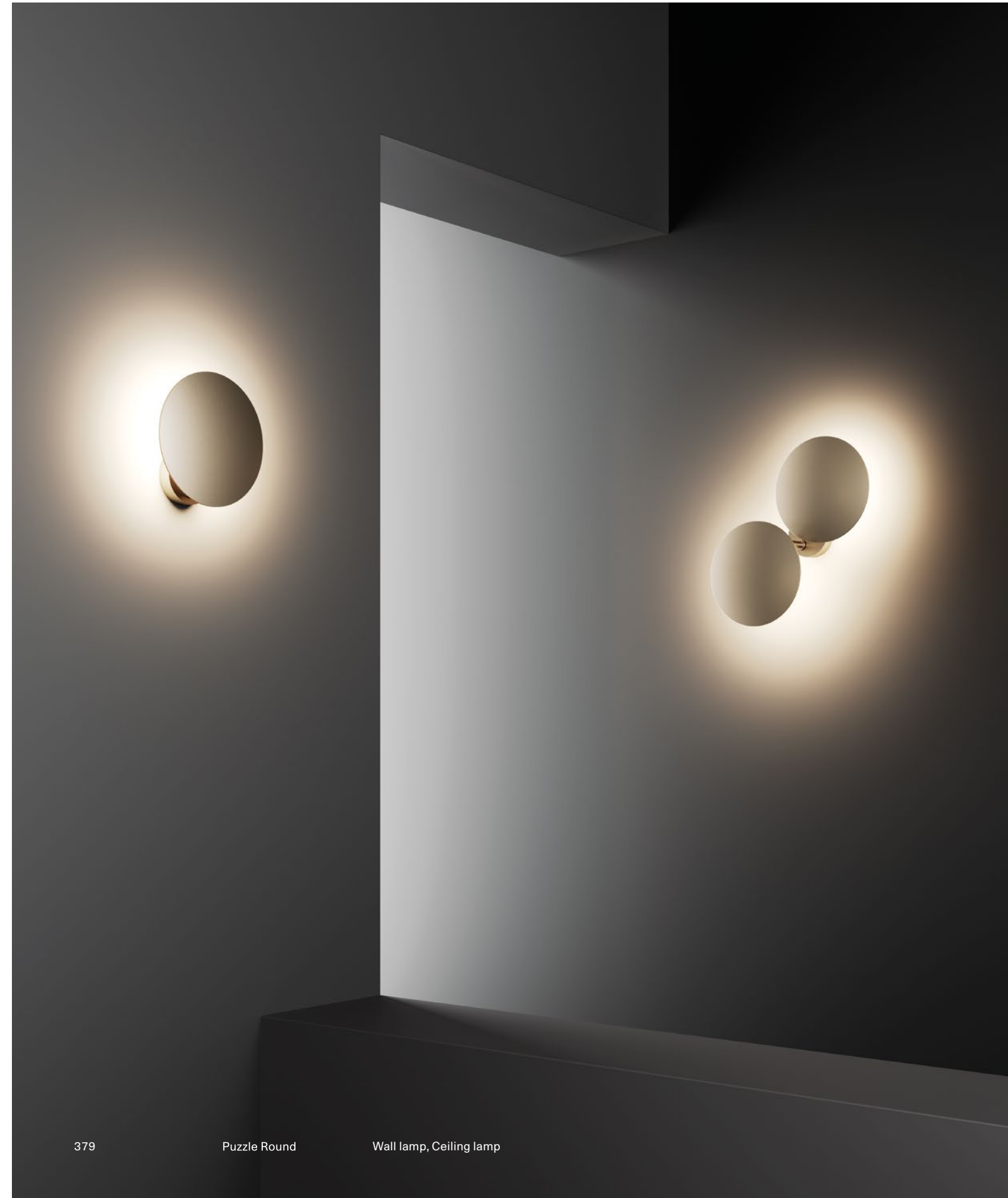



Puzzle Round double, FINISH Champagne



Puzzle Round single and double, FINISH Champagne



Puzzle Round single, FINISH Coppery Bronze



Puzzle Round single, FINISH Coppery Bronze



Puzzle Round double, FINISH Matte Black



1



2

1, 2–Puzzle Round single,
FINISH Matte White

Avec ses formes souples, les joints flexibles et la source lumineuse à LED, Puzzle Round peut être réglée à discrétion pour créer des jeux de lumière suggestifs sur les murs et les plafonds. Son esthétique discrète et les quatre finitions disponibles, y compris le Champagne, la rendent parfaite pour des contextes de vie variés. ●FR

Durch ihre weichen Formen, die flexiblen Gelenke und die LED-Lichtquelle kann Puzzle Round nach Belieben eingestellt werden, um wunderbare Lichtspiele an Wänden und Decken entstehen zu lassen. Die unauffällige Ästhetik und die vier verfügbaren Ausführungen - jetzt auch Champagner - machen die Leuchte perfekt für verschiedene Wohnbereiche. ●DE

Con sus formas suaves, articulaciones flexibles y fuente de luz LED, Puzzle Round puede ajustarse a voluntad para crear sorprendentes efectos de luz en paredes y techos. La estética discreta y los cuatro acabados disponibles, ahora incluyendo Champán, lo hacen perfecto para una amplia variedad de entornos. ●ES

Благодаря своим мягким формам, гибким соединительным элементам и источнику света LED, светильник Puzzle Round можно регулировать по желанию для создания эффектной игры света на стенах и потолках. Неброский дизайн и четыре доступных варианта отделки, теперь включающие шампанне, делают его идеальным для разных жилых контекстов. ●RU

柔软的外形，灵活的接头和LED光源，Puzzle Round可以根据需要进行调整，以在墙壁和天花板上营造出光线的暗示性。谨慎的美学设计以及如今包含香槟色在内的四种可用颜色，使其非常适合各种房屋环境。●ZH

Visit website:



Puzzle Round single » Wall lamp

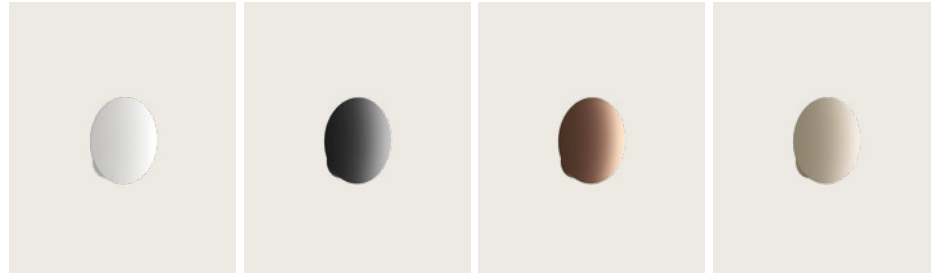

Puzzle Round single » Ceiling lamp



Puzzle Round double » Wall lamp

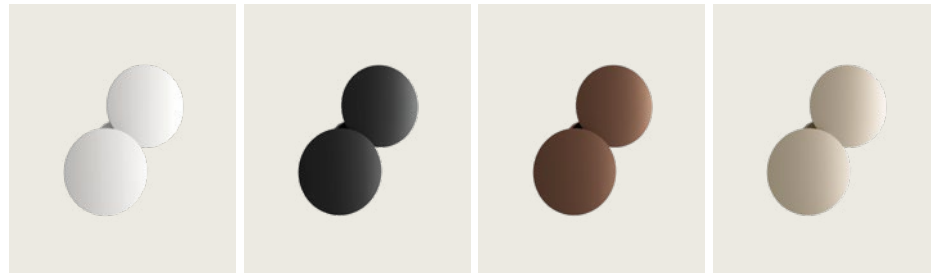

Puzzle Round double » Ceiling lamp



Puzzle Round, design by Studio Italia Design, 2016

Wall lamp

Ceiling lamp

Puzzle Round single

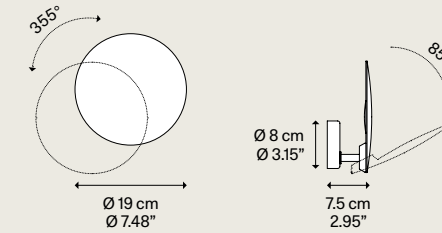

Light source
Sorgente luminosa

LED
» 2700 K
» 15 W/1750 lm
» 220-240 V
» CRI 92
» MacAdam 3-Step

LED
» 3000 K
» 15 W/1850 lm
» 220-240 V
» CRI 92
» MacAdam 3-Step

LED included
LED incluso



Adjustable light
Luce orientabile

Net weight/Peso netto: 0.6 kg

Pack/Colli: 1

Energy class/Classe energetica: F

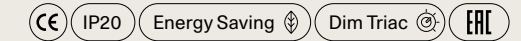

Metal structure
Montatura in metallo

Matte White - 9016
Bianco Opaco - 9016

Matte Black - 9005
Nero Opaco - 9005

Coppery Bronze
Bronzo Ramato

Champagne
Champagne

Matte White - 9016
Bianco Opaco - 9016

Matte Black - 9005
Nero Opaco - 9005

Coppery Bronze
Bronzo Ramato

Champagne
Champagne

Code
Codice

15941 1027

15941 2027

15941 3527

15941 4527

15941 1030

15941 2030

15941 3530

15941 4530

Puzzle Round double

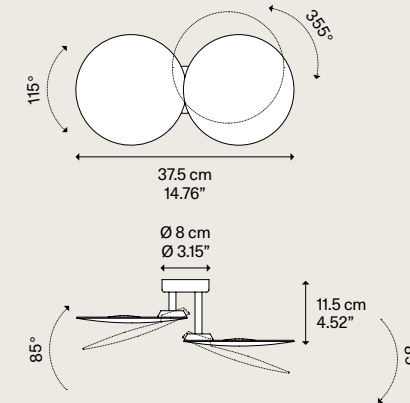

LED
» 2700 K
» 2 x 15 W/3500 lm
» 220-240 V
» CRI 92
» MacAdam 3-Step

LED
» 3000 K
» 2 x 15 W/3700 lm
» 220-240 V
» CRI 92
» MacAdam 3-Step

LED included
LED incluso



Adjustable light
Luce orientabile

Net weight/Peso netto: 1.1 kg

Pack/Colli: 1

Energy class/Classe energetica: F

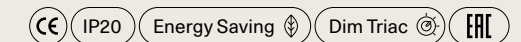

Matte White - 9016
Bianco Opaco - 9016

Matte Black - 9005
Nero Opaco - 9005

Coppery Bronze
Bronzo Ramato

Champagne
Champagne

Matte White - 9016
Bianco Opaco - 9016

Matte Black - 9005
Nero Opaco - 9005

Coppery Bronze
Bronzo Ramato

Champagne
Champagne

15942 1027

15942 2027

15942 3527

15942 4527

15942 1030

15942 2030

15942 3530

15942 4530

Ecodesign regulation ► pag. 444-445
Regolamento di Ecodesign ► pag. 444-445

LED sources with direct power supply to the AC line voltage - driver not required.
Dimmable with phase cut dimmer.

LED con alimentazione diretta a tensione di rete - non necessita di driver.
Dimmerabile con varialuce a taglio di fase.

Puzzle

Essential forms in metal, square and rectangular, which seem to disappear in the ceiling or wall. Clear-cut geometries that create suggestive plays of light on walls and ceilings, making for a truly personalised atmosphere. With Puzzle lamps, light becomes the feature element of living spaces, creating soft, geometric effects.

Forme essenziali in metallo, quadrati e rettangoli che sembrano scomparire nel soffitto o nella parete. Geometria rigorose che possono essere regolate a piacimento per creare suggestivi giochi di luce su pareti e soffitti, rendendo l'atmosfera del tutto personale. Le lampade Puzzle rendono la luce il vero ornamento degli ambienti abitativi creando effetti di morbide geometrie.

Wall lamp, Ceiling lamp

Puzzle single square,
FINISH Matte Black

Puzzle, *design by* Studio Italia Design, 2014





Puzzle double square, FINISH Matte Black

Puzzle single square,
FINISH Matte Black





Puzzle square & rectangle, FINISH Matte White



Puzzle double square, FINISH Matte White

Formes essentielles en métal, carrées et rectangulaires qui semblent disparaître dans le plafond ou le mur. Des géométries rigoureuses qui créent des jeux de lumières suggestifs sur les murs et plafonds pour créer une atmosphère personnelle. Les lampes Puzzle font de la lumière une décoration des espaces de vie et créent des effets géométriques harmonieux. ● FR

Einfache Formen aus Metall, quadratisch und rechteckig, die in der Decke oder in der Wand zu verschwinden scheinen. Klare Geometrien, die an Wänden und Decken wunderbare Lichtspiele erzeugen, um die Atmosphäre vollkommen persönlich zu gestalten. Die Leuchten Puzzle machen das Licht zum wahren Ornament von Wohnräumen und lassen Effekte mit weicher geometrischer Form entstehen. ● DE

Formas esenciales de metal, cuadrados y rectángulos que parecen desaparecer en el techo o la pared. Rigurosas geometrías que crean sugestivos efectos de luz en paredes y techos haciendo que la atmósfera sea completamente personal. Las lámparas Puzzle hacen que la luz sea el verdadero ornamento de los espacios habitables, creando efectos de geometrías suaves. ● ES

Простые формы из металла, квадраты и прямоугольники, которые как бы исчезают в потолке или стене. Строгие геометрические формы, которые можно отрегулировать по своему вкусу, создавая живописную игру света на стенах и потолках и полностью персонализируя атмосферу. Светильники Puzzle превращают свет в истинный декоративный элемент жилых интерьеров, создавая мягкие геометрические эффекты. ● RU

基本的金属形状，是似乎在吸顶灯和壁灯中消失的正方形和矩形。严格的几何形状可以随意调节，在墙壁和天花板上营造出暗示性的光线，使氛围完全个性化。Puzzle灯通过创造柔和的几何效果，使照明成为生活空间的真正装饰品。● ZH

Visit website:



Puzzle single square ↘ Wall lamp

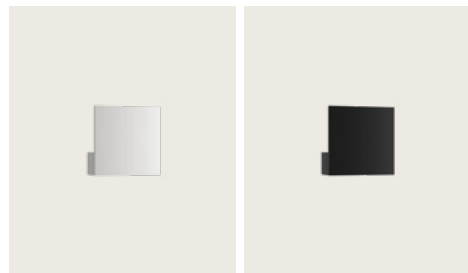

Puzzle single square ↘ Ceiling lamp



Puzzle double square ↘ Wall lamp

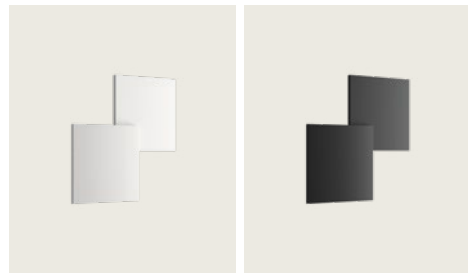

Puzzle double square ↘ Ceiling lamp



Puzzle square & rectangle ↘ Wall lamp



Puzzle square & rectangle ↘ Ceiling lamp

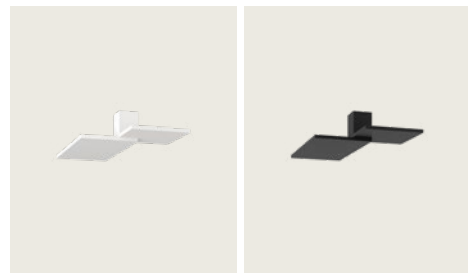

Puzzle, design by Studio Italia Design, 2014

Wall lamp

Ceiling lamp

Puzzle single square

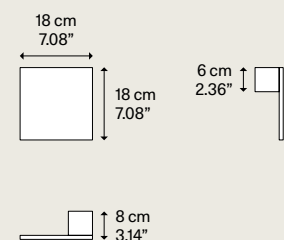

Light source
Sorgente luminosa

LED
↘ 2700 K
↘ 15 W/1750 lm
↘ 220-240 V
↘ CRI 92
↘ MacAdam 3-Step

Metal structure
Montatura in metallo

● Matte White – 9016
Bianco Opaco – 9016

Code
Codice

14641 1027

● Matte Black – 9005
Nero Opaco – 9005

14641 2027

or

● Matte White – 9016
Bianco Opaco – 9016

14641 1030

● Matte Black – 9005
Nero Opaco – 9005

14641 2030

LED included
LED incluso

Net weight/Peso netto: 1.16 kg

Pack/Colli: 1

Energy class/Classe energetica: F

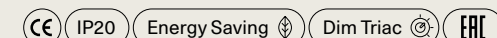

Puzzle double square

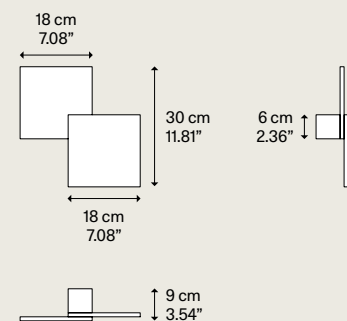

Light source

LED
↘ 2700 K
↘ 2 x 15 W/3500 lm
↘ 220-240 V
↘ CRI 92
↘ MacAdam 3-Step

● Matte White – 9016
Bianco Opaco – 9016

14642 1027

● Matte Black – 9005
Nero Opaco – 9005

14642 2027

or

● Matte White – 9016
Bianco Opaco – 9016

14642 1030

● Matte Black – 9005
Nero Opaco – 9005

14642 2030

LED included
LED incluso

Net weight/Peso netto: 2 kg

Pack/Colli: 1

Energy class/Classe energetica: F

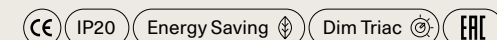

Puzzle square & rectangle

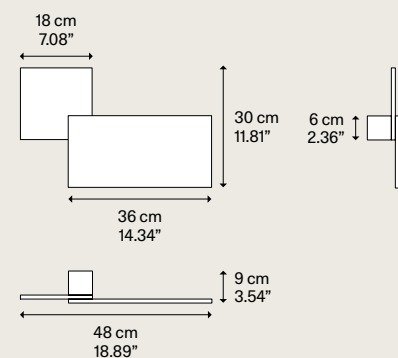

Light source

LED
↘ 2700 K
↘ 2 x 15 W/3500 lm
↘ 220-240 V
↘ CRI 92
↘ MacAdam 3-Step

● Matte White – 9016
Bianco Opaco – 9016

14643 1027

● Matte Black – 9005
Nero Opaco – 9005

14643 2027

or

● Matte White – 9016
Bianco Opaco – 9016

14643 1030

● Matte Black – 9005
Nero Opaco – 9005

14643 2030

LED included
LED incluso

Net weight/Peso netto: 2.91 kg

Pack/Colli: 1

Energy class/Classe energetica: F

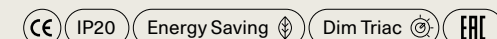

Ecodesign regulation ▶ pag. 444-445
Regolamento di Ecodesign ▶ pag. 444-445

▶ LED sources with direct power supply to the AC line voltage – driver not required. Dimmable with phase cut dimmer.
▶ Optional backplate available.

▶ LED con alimentazione diretta a tensione di rete – non necessita di driver. Dimmerabile con varialuce a taglio di fase.
▶ Disponibile piastra a muro opzionale.

Puzzle Outdoor

Puzzle Outdoor is a collection designed to enhance the outdoor spaces of homes and buildings, from the façade to the terrace, making them pleasant and comfortable at any time of day. Discrete by day, adaptable to any type of architecture, these lamps featured in essential shapes light up suggestive atmospheres after sundown.

Puzzle Outdoor è una collezione progettata per valorizzare gli spazi esterni di abitazioni ed edifici, dalla facciata alla terrazza, e renderli piacevoli e confortevoli in ogni momento della giornata. Discrete di giorno, adatte ad ogni tipo di architettura, queste lampade dalle geometrie essenziali accendono atmosfere suggestive dopo il tramonto.

Wall lamp

Puzzle Outdoor round double,
FINISH Matte White

Puzzle Outdoor, *design by* Studio Italia Design, 2019

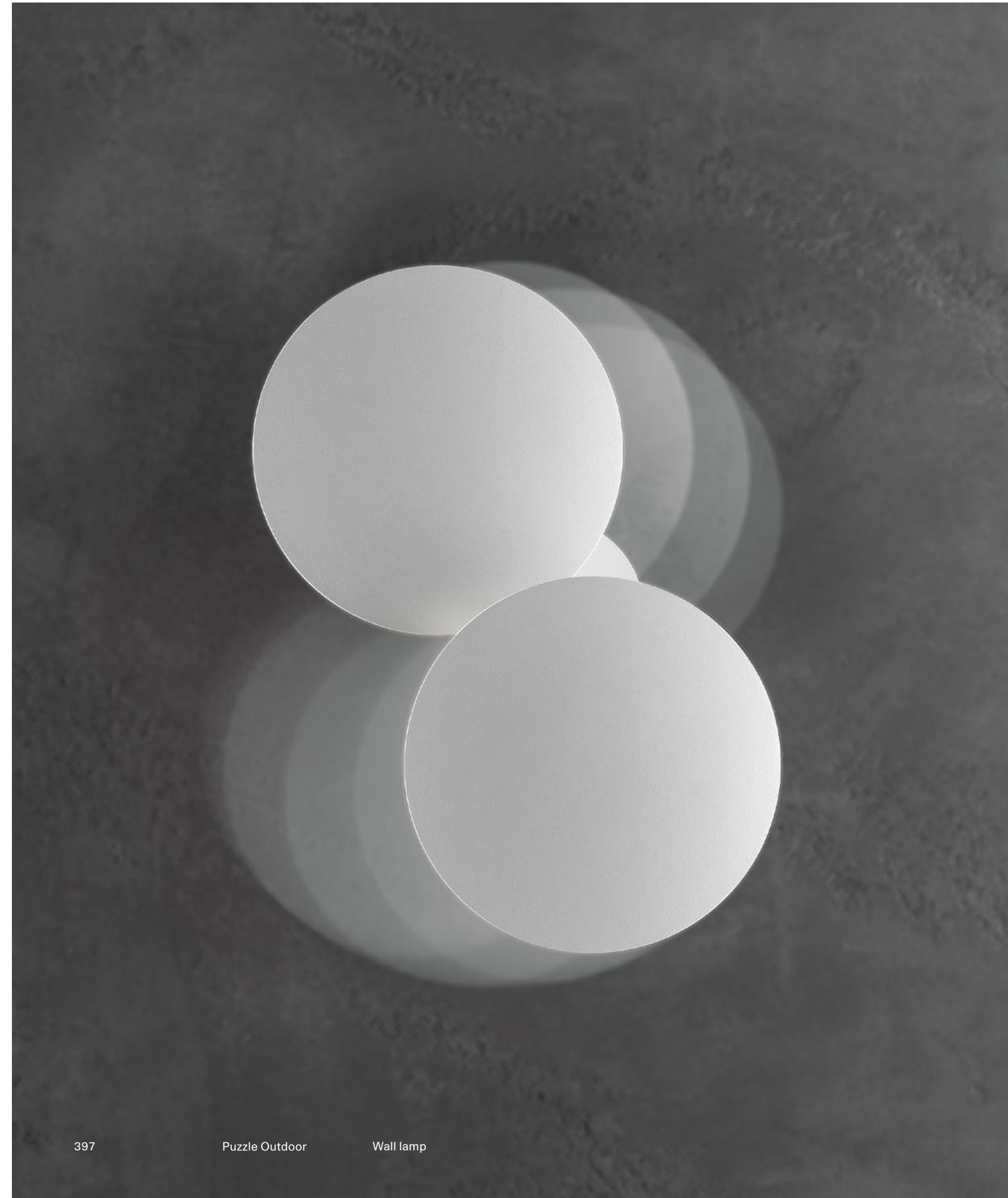



Puzzle Outdoor single square
and square & rectangle,
FINISH Anthracite Black

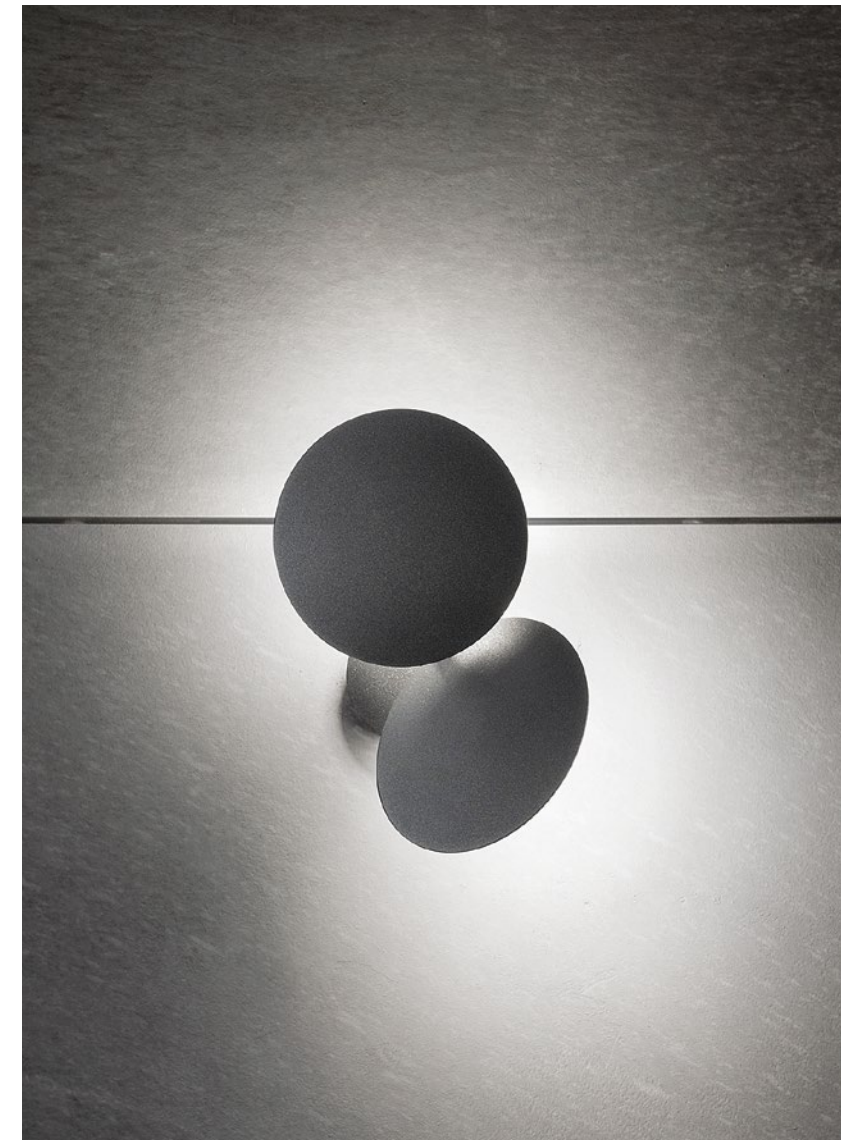

Puzzle Outdoor round double,
FINISH Anthracite Black



Puzzle Outdoor round single,
FINISH Matte White

Puzzle Outdoor est une collection conçue pour valoriser les espaces extérieurs des habitations et des bâtiments, de la façade à la terrasse, et les rendre plaisants et confortables à tout moment de la journée. Discret le jour, adapté à tout type d'architecture, ces luminaires aux géométries essentielles offrent une atmosphère suggestive après le coucher du soleil. ● FR

Puzzle Outdoor ist eine Kollektion, die entworfen wurde, um Außenräumen von Wohn- und öffentlichen Gebäuden von der Fassade bis hin zur Terrasse in Szene zu setzen und zu jeder Tageszeit angenehm und wohlig zu machen. Tagsüber diskret und für jeden Architekturstil geeignet, lassen diese Leuchten mit einfacher Form nach dem Sonnenuntergang wunderbare Atmosphären entstehen. ● DE

Puzzle Outdoor es una colección diseñada para realizar los espacios exteriores de las casas y edificios, desde la fachada hasta la terraza, y hacerlos agradables y cómodos a cualquier hora del día. Discretas durante el día, adecuadas para todo tipo de arquitectura, estas lámparas de geometría esencial iluminan sugestivas atmósferas después del atardecer. ● ES

Puzzle Outdoor – это коллекция, разработанная для оформления и освещения наружных пространств домов и зданий, от фасада до террасы, чтобы сделать их привлекательными и комфортными в любое время суток. Неброские в дневное время, подходящие для любого типа архитектуры, после захода солнца эти светильники с простым геометрическим дизайном освещают и создают восхитительную атмосферу. ● RU

Puzzle Outdoor系列旨在改善房屋和建筑物的户外空间，从外墙到露台，使其在一天中的任何时候都舒适宜人。白天不太显眼，适合任何类型的建筑，该款灯具具有基本的几何形状，在日落之后会散发出令人愉悦的气氛。● ZH

Visit website:



Puzzle Outdoor single square › Wall lamp

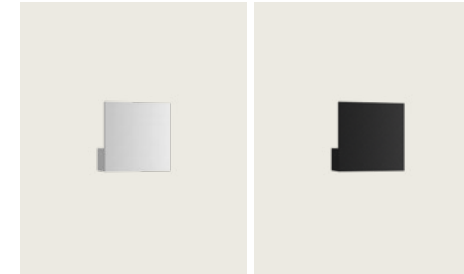

Puzzle Outdoor round single › Wall lamp

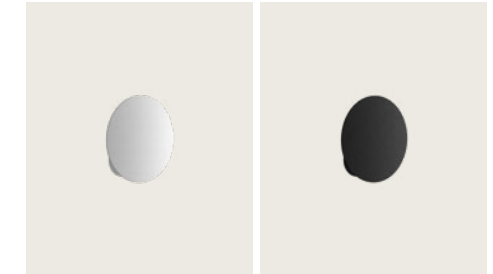

Puzzle Outdoor double square › Wall lamp

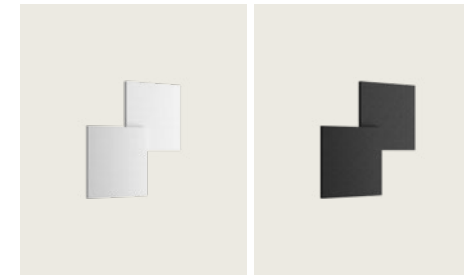

Puzzle Outdoor round double › Wall lamp

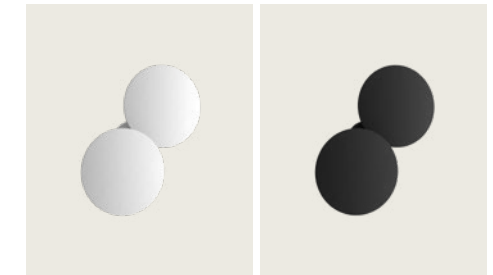

Puzzle Outdoor square & rectangle › Wall lamp



Puzzle Outdoor, design by Studio Italia Design, 2019

Wall lamp

Puzzle Outdoor single square

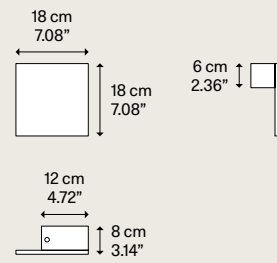

Light source
Sorgente luminosa

LED
 ↘ 3000 K
 ↘ 16 W/1700 lm
 ↘ 220-240 V
 ↘ CRI 92
 ↘ MacAdam 3-Step

Metal structure
Montatura in metallo

● Matte White - 9016
Bianco Opaco - 9016

● Anthracite Black
Nero Antracite

Code
Codice

14693 1030

14693 4430

LED included
LED incluso

Net weight/Peso netto: 1.34 kg

Pack/Coll: 1

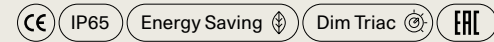

Puzzle Outdoor double square

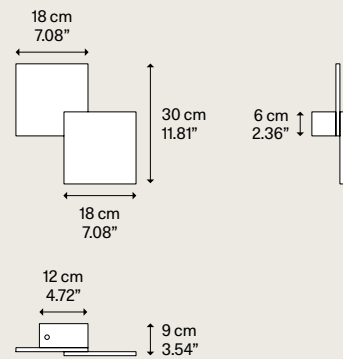

LED
 ↘ 3000 K
 ↘ 2 x 16 W/3400 lm
 ↘ 220-240 V
 ↘ CRI 92
 ↘ MacAdam 3-Step

● Matte White - 9016
Bianco Opaco - 9016

● Anthracite Black
Nero Antracite

14692 1030

14692 4430

LED included
LED incluso

Net weight/Peso netto: 2.27 kg

Pack/Coll: 1

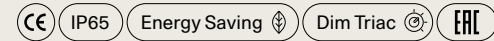

Puzzle Outdoor square & rectangle

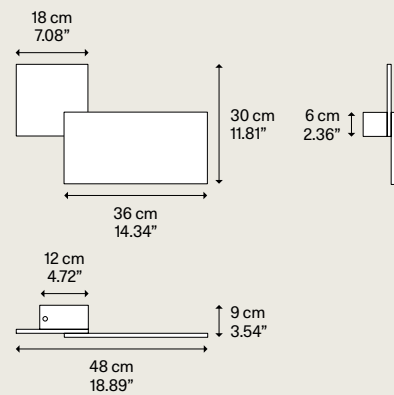

LED
 ↘ 3000 K
 ↘ 2 x 16 W/3400 lm
 ↘ 220-240 V
 ↘ CRI 92
 ↘ MacAdam 3-Step

● Matte White - 9016
Bianco Opaco - 9016

● Anthracite Black
Nero Antracite

14694 1030

14694 4430

LED included
LED incluso

Net weight/Peso netto: 3.24 kg

Pack/Coll: 1

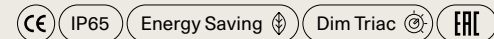

LED sources with direct power supply to the AC line voltage - driver not required. Dimmable with phase cut dimmer.

LED con alimentazione diretta a tensione di rete - non necessita di driver. Dimmerabile con varialuce a taglio di fase.

Puzzle Outdoor, design by Studio Italia Design, 2019

Wall lamp

Puzzle Outdoor round single

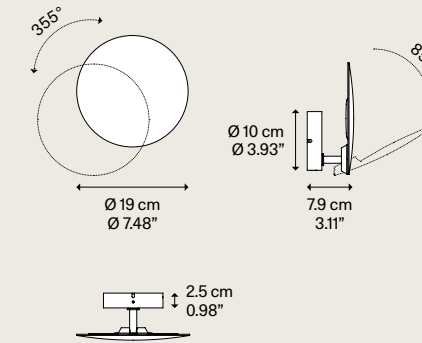

Light source
Sorgente luminosa

LED
 ↘ 3000 K
 ↘ 16 W/1700 lm
 ↘ 220-240 V
 ↘ CRI 92
 ↘ MacAdam 3-Step

Metal structure
Montatura in metallo

● Matte White - 9016
Bianco Opaco - 9016

● Anthracite Black
Nero Antracite

Code
Codice

15991 1030

15991 4430

LED included
LED incluso

Adjustable light
Luce orientabile



Net weight/Peso netto: 0.72 kg

Pack/Coll: 1

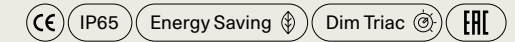

Puzzle Outdoor round double

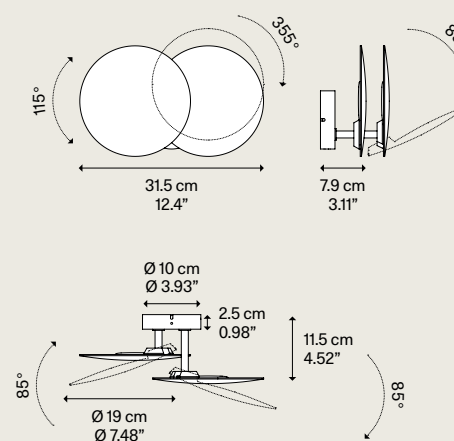

LED
 ↘ 3000 K
 ↘ 2 x 16 W/3400 lm
 ↘ 220-240 V
 ↘ CRI 92
 ↘ MacAdam 3-Step

● Matte White - 9016
Bianco Opaco - 9016

● Anthracite Black
Nero Antracite

15992 1030

15992 4430

LED included
LED incluso

Adjustable light
Luce orientabile

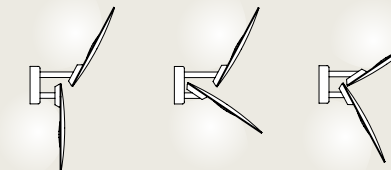

Net weight/Peso netto: 1.30 kg

Pack/Coll: 1

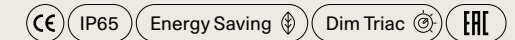

LED sources with direct power supply to the AC line voltage - driver not required. Dimmable with phase cut dimmer.

LED con alimentazione diretta a tensione di rete - non necessita di driver. Dimmerabile con varialuce a taglio di fase.

Bugia

Round, compact forms featuring elegant finishes with a centre that shines like a precious stone. Once lit up, Bugia amazes with the unexpected effect of its light. A surprising and harmonious balance between direct and indirect light, diffused both downward and up toward the ceiling. A rich family of ceiling lights, in Single, Double, Triple and Mega versions.

Forme rotonde compatte dalle finiture raffinate con un centro che splende come una pietra preziosa. Appena viene accesa, Bugia sorprende per l'effetto inaspettato della sua luce. Un inaspettato equilibrio armonico tra luce diretta e indiretta, diffusa sia verso il basso che verso il soffitto. Una ricca famiglia di plafoniere, in versione Single, Double, Triple e Mega.

Ceiling lamp

Bugia Triple, Single, Mega and Double,
FINISHES Glossy White and Glossy Black

Bugia, *design by* Andrea Toso, 2016/2020





Bugia Double, FINISH Chrome

Bugia Triple and Single,
FINISH Glossy White





Bugia Mega, FINISH Glossy Bronze

Forme ronde compacte aux finitions raffinées avec un point central qui brille comme une pierre précieuse. Une fois allumée, Bugia surprend par l'effet inattendu de sa lumière. Un harmonieux équilibre inattendu entre lumière directe et indirecte, diffusée vers le bas ou vers le plafond. Une riche famille de plafonniers, en version Single, Double, Triple et Mega. ●FR

Kompakte, runde Formen mit raffinierten Ausführungen und einem Mittelpunkt, der wie ein Edelstein funkelt. Beim Einschalten überrascht Bugia durch den unerwarteten Effekt ihres Lichts. Ein unerwartet harmonisches Gleichgewicht zwischen direktem und indirektem Licht, das sowohl nach unten wie auch zur Decke gestrahlt wird. Eine ganze Familie von Deckenleuchten, in Single-, Double-, Triple- und Mega-Versionen. ●DE

Formas redondas compactas con acabados refinados con un centro que brilla como una piedra preciosa. Tan pronto como se enciende, Bugia sorprende con el inesperado efecto de su luz. Un inesperado equilibrio armónico entre la luz directa e indirecta, difusa tanto hacia abajo como hacia el techo. Una rica familia de lámparas de techo, en versiones Single, Double, Triple y Mega. ●ES

Компактные круглые формы с изысканной отделкой, в центре которых как бы сияет драгоценный камень. Сразу же при включении светильник Bugia поражает своим потрясающим световым эффектом. Неожиданно уравновешенная гармония между прямым и непрямым светом, распространяющимся как вниз, так и к потолку. Богатая семья плафонов в вариации Single, Double, Triple и Mega. ●RU

Bugia圆形灯,紧凑的形状有着优雅的饰面,其中心部分犹如宝石一般闪耀。一经点亮,Bugia就会以其意想不到的灯光效果而惊艳众生。直射照明与间接照明之间有着令人惊叹的和谐平衡,向下扩散的同时亦可向上漫射至天花板。它是一款丰富多样的吸顶灯系列,有单灯、双灯、三灯和Mega巨型版本。●ZH

Visit website:



Bugia Single » Ceiling lamp



Bugia Double » Ceiling lamp



Bugia Triple » Ceiling lamp



Bugia Mega » Ceiling lamp

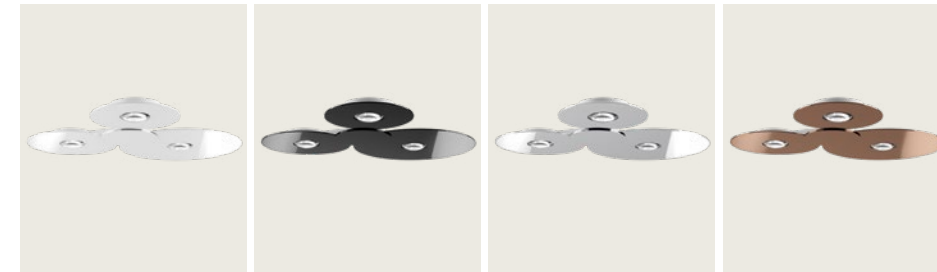

Bugia, design by Andrea Tosetto, 2016

Ceiling lamp

Bugia Single

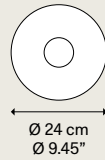
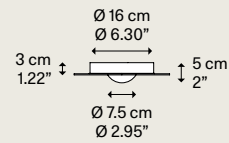

Light source
Sorgente luminosa

LED
↘ 2700 K
↘ 15 W/1245 lm
↘ 220-240 V
↘ CRI 90
↘ MacAdam 3-Step

Matte White - 9010
Bianco Opaco - 9010

or

LED
↘ 3000 K
↘ 15 W/1355 lm
↘ 220-240 V
↘ CRI 90
↘ MacAdam 3-Step

Matte White - 9010
Bianco Opaco - 9010

LED included
LED incluso

Metal structure
Montatura in metallo

Methacrylate diffuser
Diffusore in metacrilato

Code
Codice

Glossy White Bianco Lucido	16131 1227
Glossy Black Nero Lucido	16131 2227
Chrome Cromo	16131 4027
Glossy Bronze Bronzo Lucido	16131 4627
Glossy White Bianco Lucido	16131 1230
Glossy Black Nero Lucido	16131 2230
Chrome Cromo	16131 4030
Glossy Bronze Bronzo Lucido	16131 4630

Net weight/Peso netto: 0.8 kg Pack/Colli: 2 Energy class/Classe energetica: F

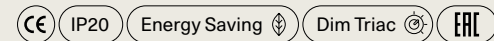

Bugia Double

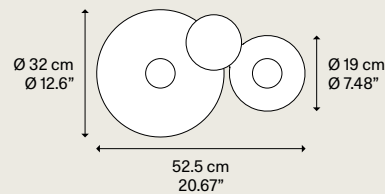
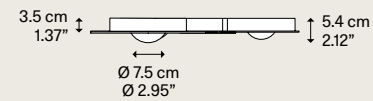

LED
↘ 2700 K
↘ 2 x 15 W/2490 lm
↘ 220-240 V
↘ CRI 90
↘ MacAdam 3-Step

Matte White - 9010
Bianco Opaco - 9010

or

LED
↘ 3000 K
↘ 2 x 15 W/2710 lm
↘ 220-240 V
↘ CRI 90
↘ MacAdam 3-Step

Matte White - 9010
Bianco Opaco - 9010

LED included
LED incluso

Metal structure
Montatura in metallo

Methacrylate diffuser
Diffusore in metacrilato

Code
Codice

Glossy White Bianco Lucido	16132 1227
Glossy Black Nero Lucido	16132 2227
Chrome Cromo	16132 4027
Glossy Bronze Bronzo Lucido	16132 4627
Glossy White Bianco Lucido	16132 1230
Glossy Black Nero Lucido	16132 2230
Chrome Cromo	16132 4030
Glossy Bronze Bronzo Lucido	16132 4630

Net weight/Peso netto: 2.05 kg Pack/Colli: 2 Energy class/Classe energetica: F

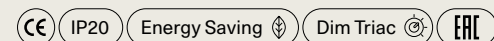

Ecodesign regulation ► pag. 444-445
Regolamento di Ecodesign ► pag. 444-445

LED sources with direct power supply to the AC line voltage - driver not required. Dimmable with phase cut dimmer.

LED con alimentazione diretta a tensione di rete - non necessita di driver. Dimmerabile con varialuce a taglio di fase.

Bugia, design by Andrea Tosetto, 2016

Ceiling lamp

Bugia Triple

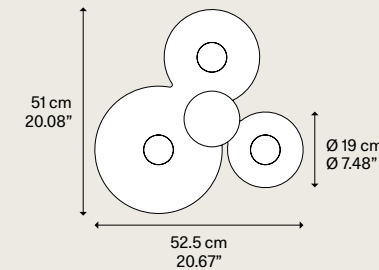
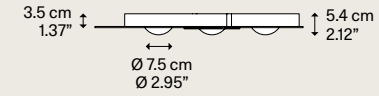

Light source
Sorgente luminosa

LED
↘ 2700 K
↘ 3 x 15 W/3735 lm
↘ 220-240 V
↘ CRI 90
↘ MacAdam 3-Step

Matte White - 9010
Bianco Opaco - 9010

or

LED
↘ 3000 K
↘ 3 x 15 W/4065 lm
↘ 220-240 V
↘ CRI 90
↘ MacAdam 3-Step

Matte White - 9010
Bianco Opaco - 9010

LED included
LED incluso

Metal structure
Montatura in metallo

Methacrylate diffuser
Diffusore in metacrilato

Code
Codice

Glossy White Bianco Lucido	16133 1227
Glossy Black Nero Lucido	16133 2227
Chrome Cromo	16133 4027
Glossy Bronze Bronzo Lucido	16133 4627
Glossy White Bianco Lucido	16133 1230
Glossy Black Nero Lucido	16133 2230
Chrome Cromo	16133 4030
Glossy Bronze Bronzo Lucido	16133 4630

Net weight/Peso netto: 2.8 kg Pack/Colli: 2 Energy class/Classe energetica: F

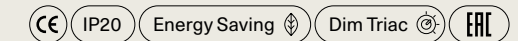

Bugia Mega, design by Andrea Tosetto, 2020

Ceiling lamp

Bugia Mega

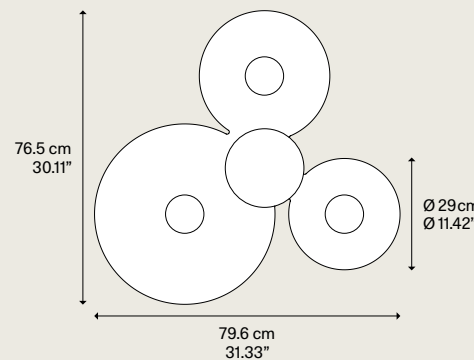
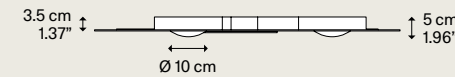

Light source
Sorgente luminosa

LED
↘ 2700 K
↘ 3 x 15 W/3735 lm
↘ 220-240 V
↘ CRI 90
↘ MacAdam 3-Step

Matte White - 9010
Bianco Opaco - 9010

or

LED
↘ 3000 K
↘ 3 x 15 W/4065 lm
↘ 220-240 V
↘ CRI 90
↘ MacAdam 3-Step

Matte White - 9010
Bianco Opaco - 9010

LED included
LED incluso

Metal structure
Montatura in metallo

Methacrylate diffuser
Diffusore in metacrilato

Code
Codice

Glossy White Bianco Lucido	16134 1227
Glossy Black Nero Lucido	16134 2227
Chrome Cromo	16134 4027
Glossy Bronze Bronzo Lucido	16134 4627
Glossy White Bianco Lucido	16134 1230
Glossy Black Nero Lucido	16134 2230
Chrome Cromo	16134 4030
Glossy Bronze Bronzo Lucido	16134 4630

Net weight/Peso netto: 4.4 kg Pack/Colli: 2 Energy class/Classe energetica: F

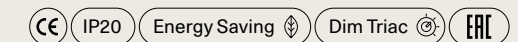

Ecodesign regulation ► pag. 444-445
Regolamento di Ecodesign ► pag. 444-445

LED sources with direct power supply to the AC line voltage - driver not required. Dimmable with phase cut dimmer.

LED con alimentazione diretta a tensione di rete - non necessita di driver. Dimmerabile con varialuce a taglio di fase.

Pin-Up

A striking, compact light with a simple, organic design, Pin-Up opens like a shell to provide a bright light and the quality of LED lighting. A light that can be modelled at will thanks to the flexibility of the light fixture and the availability of two LED sources.

Una lampada compatta e sorprendente, dal design essenziale ed organico, Pin-Up si schiude come una conchiglia per illuminare gli spazi con la decisione e la qualità della luce a LED. Una luce che può essere modellata a piacere grazie alla flessibilità della lampada e alla disponibilità di due sorgenti LED.

Wall lamp, Ceiling lamp

Pin-Up,
FINISH Matte Black

Pin-Up, *design by* Andrea Tosetto, 2015





Pin-Up, FINISH Matte White

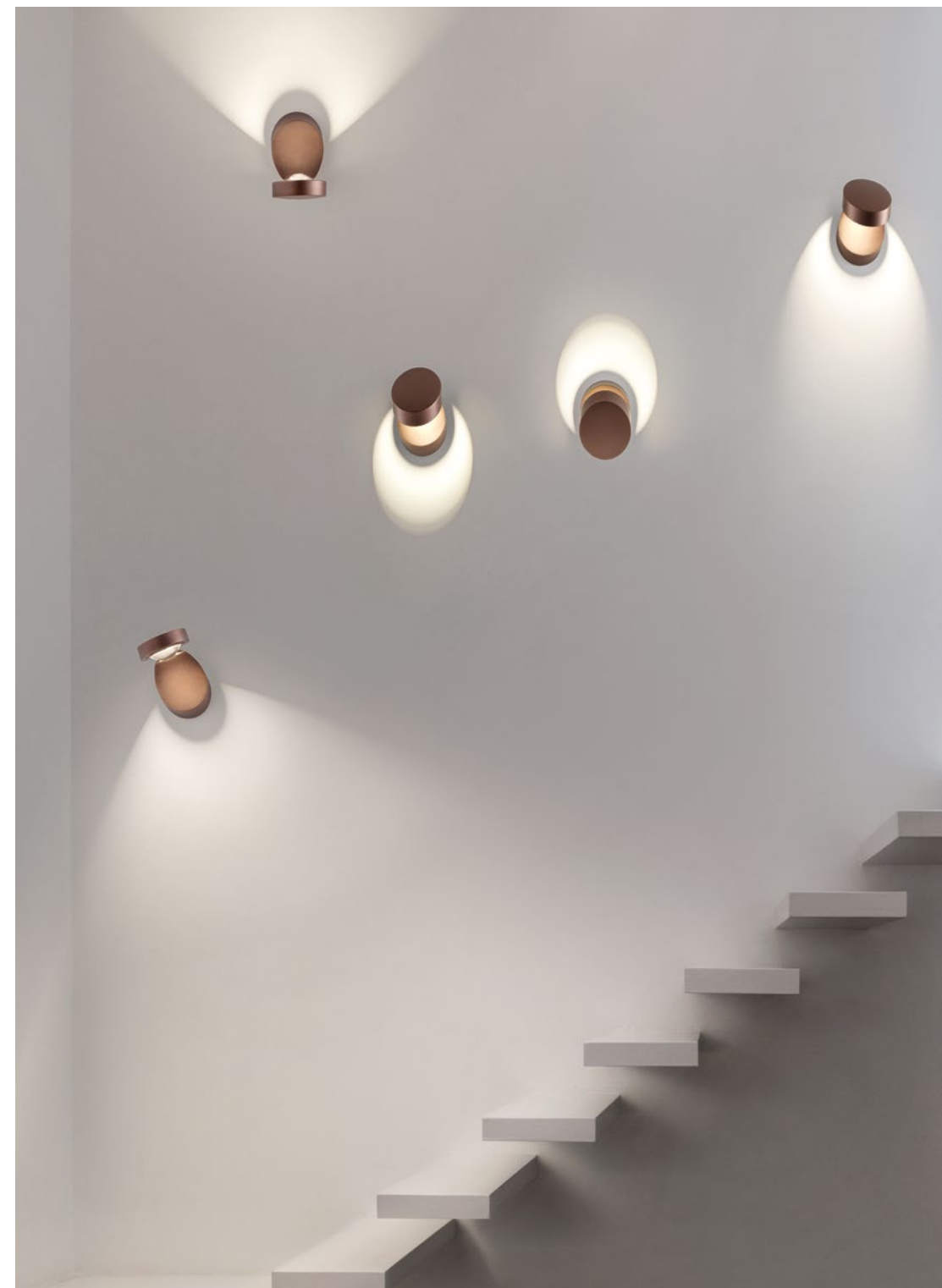

Pin-Up, FINISH Coppery Bronze

Lampe compacte et surprenante, au design essentiel et organique, Pin-Up s'ouvre comme une coquille pour éclairer les espaces avec la précision et la qualité de la lumière LED. Une lumière qui peut être modelée à souhait grâce à la flexibilité de la lampe et à la disponibilité de deux sources LED. ●FR

Als eine kompakte und überraschende Lampe mit klarem, organischem Design schließt sich Pin-Up wie eine Muschel, um Räume mit der Entschlossenheit und Qualität von LED-Licht zu erhellen. Ein Licht, das dank der Flexibilität der Lampe und des Vorhandenseins von zwei LED-Quellen verändert werden kann. ●DE

Una lámpara compacta y sorprendente, de diseño esencial y orgánico, Pin-Up se abre como una concha para iluminar los espacios con la decisión y la calidad de la luz de LED. Una luz que puede ser modelada a gusto gracias a la flexibilidad de la lámpara y a la disponibilidad de dos fuentes de LED. ●ES

Pin-Up – изумительный компактный светильник со сдержанным, органичным дизайном. Открывается как ракушка и смело освещает пространство качественным светодиодным светом. Превосходная гибкость и наличие двух светодиодных источников позволяют моделировать освещение по желанию. ●RU

Pin-Up是一款紧凑而令人惊喜的灯具，设计简洁有序，如一个贝壳打开，以坚定而优质的LED灯光照亮空间。灯身灵活，配有两盏LED光源，灯光可随喜好调节。●ZH

Visit website:



Pin-Up, design by Andrea Tosetto, 2015

Wall lamp

Ceiling lamp

Pin-Up

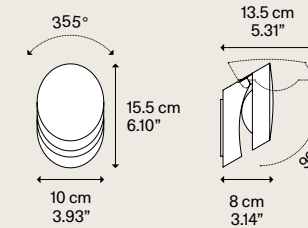

Light source
Sorgente luminosa

LED
 ↘ 2700 K
 ↘ 8 W/920 lm
 ↘ 220-240 V
 ↘ CRI 92
 ↘ MacAdam 3-Step

or

LED
 ↘ 3000 K
 ↘ 8 W/980 lm
 ↘ 220-240 V
 ↘ CRI 92
 ↘ MacAdam 3-Step

LED included
LED incluso

Metal structure
Montatura in metallo

● Matte White – 9010
Bianco Opaco – 9010

Code
Codice

15540 1027

● Matte Black – 9005
Nero Opaco – 9005

15540 2027

● Coppery Bronze
Bronzo Ramato

15540 3527

● Matte White – 9010
Bianco Opaco – 9010

15540 1030

● Matte Black – 9005
Nero Opaco – 9005

15540 2030

● Coppery Bronze
Bronzo Ramato

15540 3530

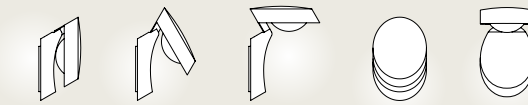

Adjustable light
Luce orientabile

Net weight/Peso netto: 1.15 kg

Pack/Colli: 1

Energy class/Classe energetica: E

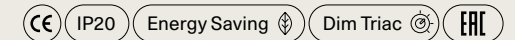

Ecodesign regulation ► pag. 444-445
Regolamento di Ecodesign ► pag. 444-445

Pin-Up ↘ Wall lamp, Ceiling lamp

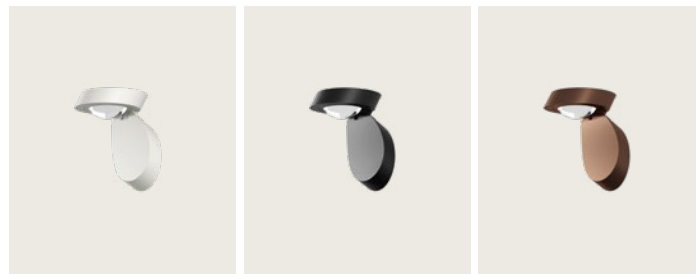

Laser

Laser is a compact, versatile light fixture in the shape of a box with an attractive architectural look. From its painted steel structure, available in one size and three different finishes, now including Champagne, the LED light source diffuses a functional and evocative two-way light that creates plays of light and shadow on the wall.

Laser è una lampada compatta a forma di parallelepipedo dal carattere versatile e architettonico. Dalla sua struttura in acciaio verniciato, disponibile in una dimensione e in tre diverse finiture, ora anche Champagne, la sorgente a LED diffonde una luce bidirezionale funzionale e d'effetto che crea giochi di luce ed ombra sulla parete.

Wall lamp

Laser 10 × 10,
FINISH Champagne

Laser, *design by* Studio Italia Design, 2015





Laser 10 × 10, FINISH Matte White

Laser 10 × 10,
FINISH Matte Black

Laser est une lampe compacte en forme de parallélépipède au caractère polyvalent et architectural. De sa structure en acier peint, disponible en taille unique et en trois finitions différentes, y compris le Champagne, la source LED diffuse une lumière bidirectionnelle fonctionnelle et efficace qui crée des jeux d'ombre et de lumière sur le mur. ●FR

Laser ist eine kompakte Lampe in Form eines Parallelepipedes mit vielseitigem und architektonischem Charakter. Durch seine Armatur aus lackiertem Stahl, die in einer Größen und drei unterschiedlichen Ausführungen - jetzt auch Champagner - verfügbar ist, verbreitet die LED-Lichtquelle bidirektionales, funktionelles sowie effektvolles Licht, wodurch ein Spiel aus Licht und Schatten an der Wand entsteht. ●DE

Laser es una lámpara compacta con forma de paralelepípedo con carácter versátil y arquitectónico. De su estructura de acero pintado, disponible en una dimensión y en tres diferentes acabados, ahora incluyendo Champán, la fuente de LED difunde una luz bidireccional funcional y con efecto que crea juegos de luz y sombra en la pared. ●ES

Laser – компактный светильник в форме параллелепипеда с многогранным архитектурным характером. Конструкция светильника выполнена из окрашенной стали, доступной в двух размерах и трех различных вариантах отделки. Светодиодный источник эффективно рассеивает двунаправленный свет, создающий на стене игру света и тени. ●RU

Laser是一款四边形的紧凑灯具，具有建筑美感，广泛适用。喷漆钢材的结构，有一种尺寸和三种不同的颜色，如今还有香槟色，LED光源散发着双向的功能灯光，在墙壁上形成光影效果。●ZH

Visit website:



Laser, design by Studio Italia Design, 2015

Wall lamp

Laser 10 × 10 LED

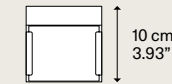
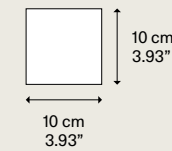

Light source
Sorgente luminosa

LED
↘ 2700 K
↘ 15 W / 1750 lm
↘ 220-240 V
↘ CRI 92
↘ MacAdam 3-Step

or

LED
↘ 3000 K
↘ 15 W / 1850 lm
↘ 220-240 V
↘ CRI 92
↘ MacAdam 3-Step

LED included
LED incluso

Metal structure
Montatura in metallo

● Matte White – 9010
Bianco Opaco – 9010

● Matte Black – 9005
Nero Opaco – 9005

● Champagne
Champagne

● Matte White – 9010
Bianco Opaco – 9010

● Matte Black – 9005
Nero Opaco – 9005

● Champagne
Champagne

Code
Codice

03652 1027

03652 2027

03652 4527

03652 1030

03652 2030

03652 4530

Net weight/Peso netto: 0.6 kg

Pack/Colli: 1

Energy class/Classe energetica: F

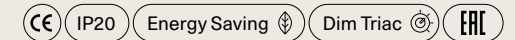

Ecodesign regulation ► pag. 444-445
Regolamento di Ecodesign ► pag. 444-445

Laser 10 × 10 ↘ Wall lamp

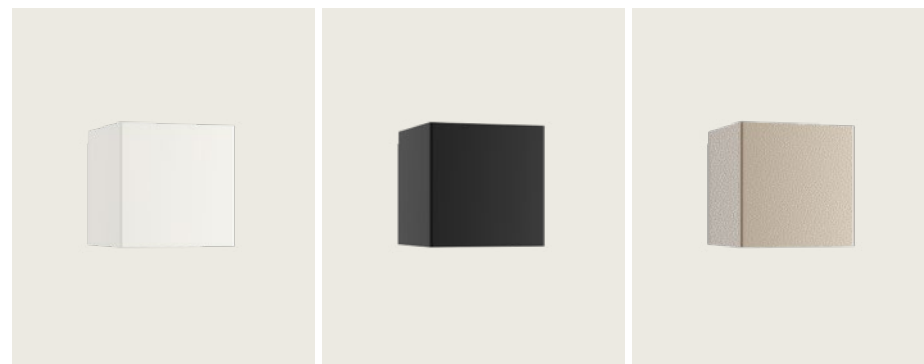

Make-Up

Make-Up's design is inspired by fashion and beauty. A versatile blown glass lamp with a gentle shape, Make-Up dresses walls and ceilings with light. Elegantly functional when used individually, it acquires a highly decorative appeal in lively compositions of different sizes and volumes.

Il design di Make-Up si ispira alla moda e alla bellezza. Lampada versatile in vetro soffiato dalla forma morbida, Make-Up veste di luce la parete e il soffitto. Elegantemente funzionale se usata singolarmente, acquista valore fortemente decorativo nelle vivaci composizioni di dimensioni e volumi diversi.

Wall lamp, Ceiling lamp

Make-Up,
FINISH Frosted White

Make-Up, *design by* Studio Italia Design, 2015





Make-Up small, medium and large, FINISH Frosted White

Le design de Make-Up est inspiré par la mode et la beauté. Lampe polyvalente en verre soufflé de forme délicate, Make-Up habille de lumière les murs et le plafond. Élégamment fonctionnel en usage individuel, elle acquiert une grande valeur décorative dans des compositions dynamiques de tailles et de volumes différents. [FR](#)

Das Design von Make-Up ist von Mode und Schönheit inspiriert. Als vielseitige Lampe aus geblasenem Glas mit ihrer weichen Form kleidet Make-Up Wand und Decke mit Licht. Bei einzelner Verwendung ist sie elegant und funktionell, als lebhaft Kombination aus verschiedenen Größen und Volumen wird sie hingegen zu einem besonderen Dekorationselement. [DE](#)

El diseño de Make-Up está inspirado en la moda y la belleza. Una versátil lámpara de vidrio soplado de forma delicada, Make-Up viste de luz la pared y el techo. Elegantemente funcional cuando se usa individualmente, adquiere un alto valor decorativo en composiciones llamativas de diferentes tamaños y volúmenes. [ES](#)

Дизайн Make-Up навеян модой и красотой. Модульный светильник из выдувного стекла мягкой формы может украсить своим светом как стену, так и потолок. Элегантен и эффективен даже по отдельности, а в составных композициях различных размеров и объемов приобретает еще большую декоративную ценность. [RU](#)

Make-Up设计灵感来自时尚与美。组合式吹制玻璃吊灯外形柔和，为墙壁或天花板增添光彩。优雅实用，单独使用具有强烈的装饰性，可组成各种尺寸和体积的活泼组合。 [ZH](#)

Visit website:



Make-Up small ↘ Wall lamp Make-Up medium ↘ Wall lamp Make-Up large ↘ Wall lamp

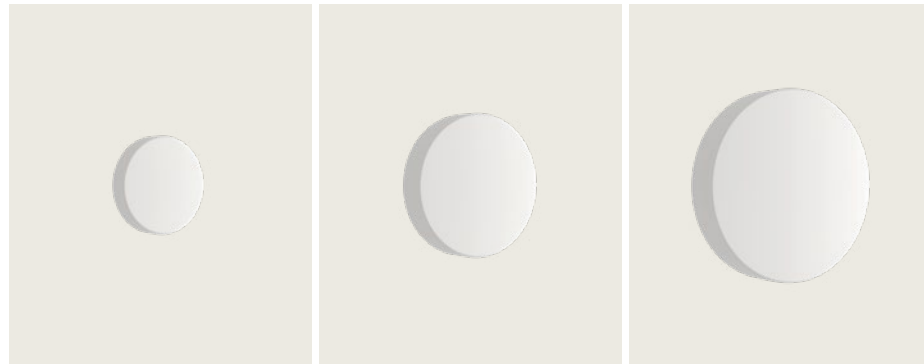

Make-Up small ↘ Ceiling lamp Make-Up medium ↘ Ceiling lamp Make-Up large ↘ Ceiling lamp

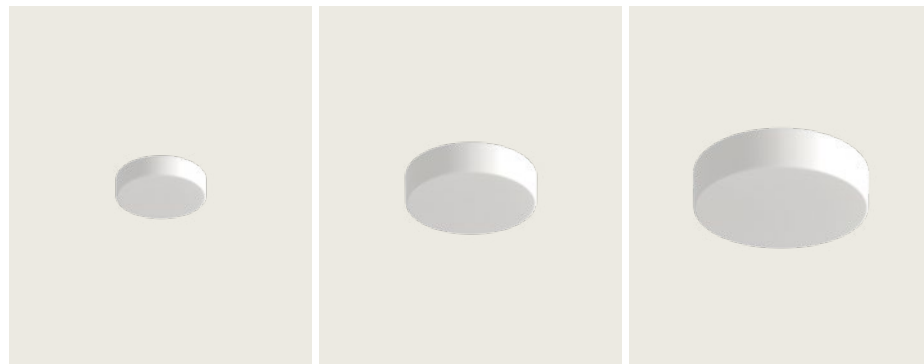

Make-Up, design by Studio Italia Design, 2015

Wall lamp

Ceiling lamp

Make-Up small

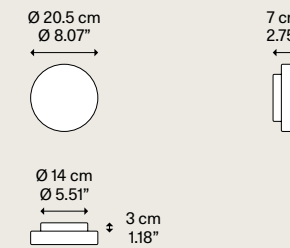

Light source
Sorgente luminosa

LED
 ↘ 3000 K
 ↘ 8 W/ 980 lm
 ↘ 220-240 V
 ↘ CRI 92
 ↘ MacAdam 3-Step

Metal structure
Montatura in metallo

● Matte White - 9016
Bianco Opaco - 9016

Blown glass diffuser
Diffusore in vetro soffiato

● Frosted White
Bianco Satinato

Code
Codice

15041 30

LED included
LED incluso

Net weight/Peso netto: 1.3 kg

Pack/Colli: 1

Energy class/Classe energetica: F

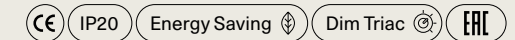

Make-Up medium

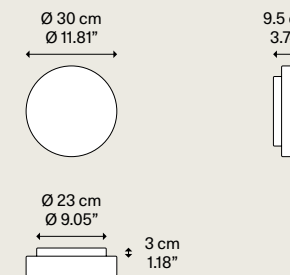

Light source
Sorgente luminosa

LED
 ↘ 3000 K
 ↘ 15 W/ 1850 lm
 ↘ 220-240 V
 ↘ CRI 92
 ↘ MacAdam 3-Step

● Matte White - 9016
Bianco Opaco - 9016

● Frosted White
Bianco Satinato

15042 30

LED included
LED incluso

Net weight/Peso netto: 2.32 kg

Pack/Colli: 1

Energy class/Classe energetica: F

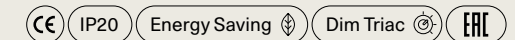

Make-Up large

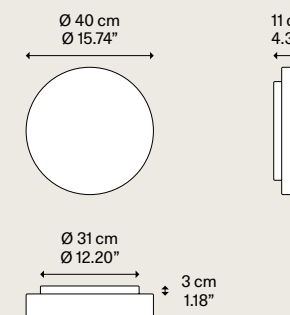

Light source
Sorgente luminosa

LED
 ↘ 3000 K
 ↘ 15 W/ 1850 lm
 ↘ 220-240 V
 ↘ CRI 92
 ↘ MacAdam 3-Step

● Matte White - 9016
Bianco Opaco - 9016

● Frosted White
Bianco Satinato

15043 30

LED included
LED incluso

Net weight/Peso netto: 3.88 kg

Pack/Colli: 1

Energy class/Classe energetica: F

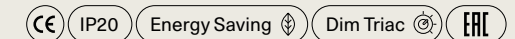

Ecodesign regulation ▶ pag. 444-445
Regolamento di Ecodesign ▶ pag. 444-445

▶ LED sources with direct power supply to the AC line voltage - driver not required. Dimmable with phase cut dimmer. ▶ You can connect up to 3 Make-Up to each fixture directly connected to the power supply. You can also connect up to 2 additional fixtures to each of those for maximum total of 50 fixtures on a single power outlet.

▶ LED con alimentazione diretta a tensione di rete - non necessita di driver. Dimmerabile con varialuce a taglio di fase. ▶ Ad ogni Make-Up connessa al punto di alimentazione elettrica possono esserne collegate altre 3. Ad ognuna di queste possono esserne collegate fino a 2 e così via. Le lampade totali collegabili su un singolo punto di alimentazione sono 50.

Canopies

Our canopies are smart functional solutions as well as stand-out decorative elements for suspension lamps or wall fixtures. The variety of our canopy range provides an array of possibilities to personalise any living spaces, whether domestic or public.

Single Round and Rectangular Radial Track

I nostri rosoni sono soluzioni funzionali e insieme elementi decorativi differenzianti per lampade a sospensione o a parete. La varietà della nostra gamma di rosoni offre una miriade di possibilità di personalizzazione degli spazi abitativi, domestici e pubblici.

Round and Rectangular Cluster Systems
Our multiple canopies, round or rectangular, are functional systems to create suspended compositions with a variable but predefined number of holes.

Sistemi Cluster Rotondi e Rettangolari
I nostri rosoni multipli, rotondi o rettangolari, sono sistemi funzionali per creare composizioni sospese con un numero di fori variabile ma predefinito.

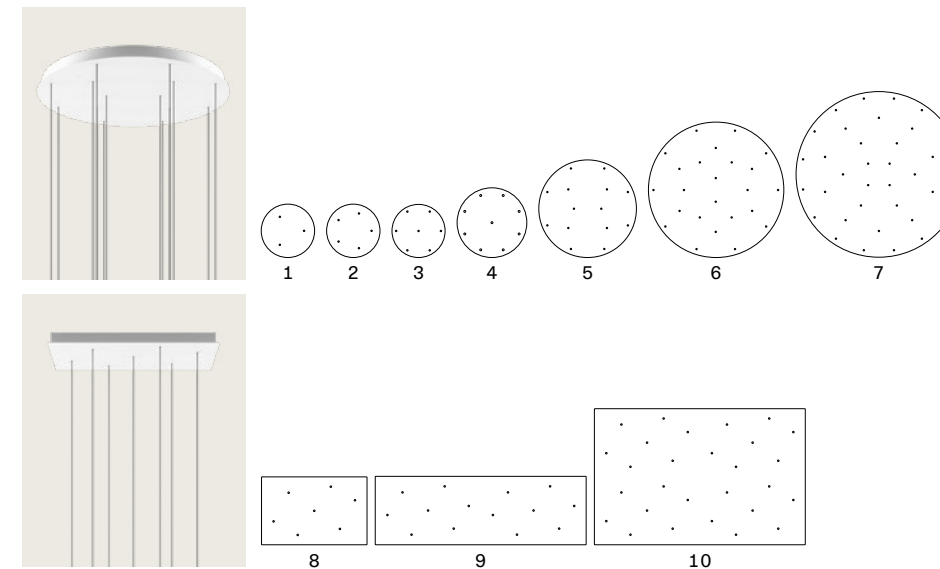

- 1 3 Lights Round
- 2 5 Lights Round
- 3 7 Lights Round
- 4 9 Lights Round
- 5 14 Lights Round
- 6 24 Lights Round
- 7 36 Lights Round
- 8 7 Lights Rectangular
- 9 14 Lights Rectangular
- 10 28 Lights Rectangular

Radial Systems
Radial systems are an innovative way to separately manage various suspension cables starting from one single canopy—particularly useful to illuminate rooms with irregular ceilings.

Sistemi Radiali
I sistemi radiali sono un modo innovativo per gestire separatamente diversi cavi di sospensione a partire da un unico rosone – particolarmente utili per illuminare ambienti con soffitti irregolari.

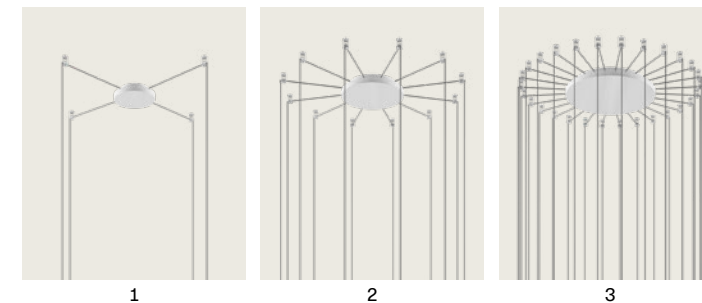

- 1 1-4 Lights Radial
- 2 5-12 Lights Radial
- 3 13-28 Lights Radial

Single Canopy
Single canopies are ideal for highlighting the corner of a room or enhancing single light sources. They can also be used to create multiple custom combinations on high ceilings or in situations which do not allow lights to be grouped in a cluster.

Rosoni Singoli
I rosoni singoli si prestano ad enfatizzare gli angoli di una stanza o a valorizzare i singoli corpi luce. Possono inoltre essere utilizzati per creare composizioni multiple personalizzate su soffitti molto alti o nelle situazioni che non permettono l'utilizzo di cluster.

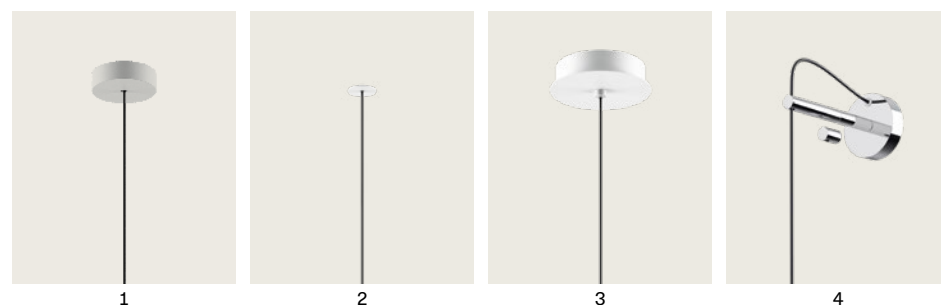

- 1 Single Mini
- 2 Recessed Micro
- 3 Single Standard
- 4 Wall Standard

Track Systems
Track systems offers various possibilities of in-line composition with a variable number of lamps depending on the preferred type of installation, i.e. height-aligned or staggered suspensions.

Sistemi a Binario Lineare
I sistemi a binario offrono varie possibilità di composizione in linea con un numero variabile di lampade a seconda del tipo di installazione desiderato, ossia sospensioni allineate in altezza o sfalsate.

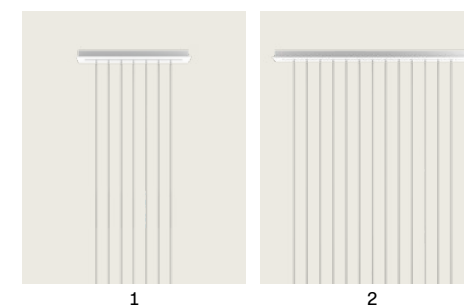

- 1 Short Lights Track
- 2 Long Lights Track

Single canopies

Single Mini

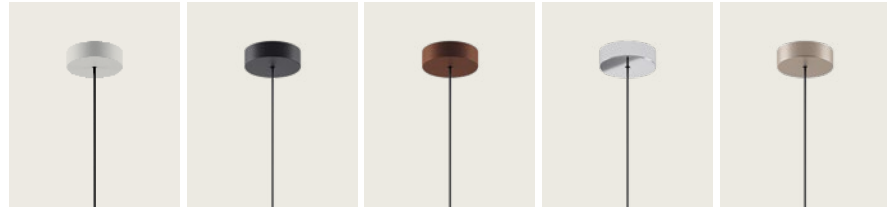

Recessed Micro

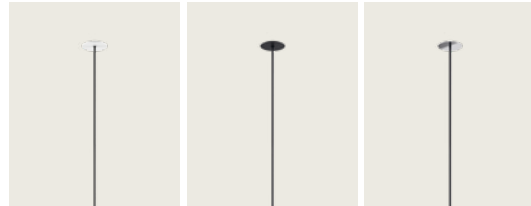

Single Standard



Wall Standard

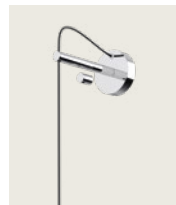

Single Canopy

Single Mini



Ø 9.5 cm
Ø 3.74"

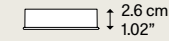

2.6 cm
1.02"

Net weight/Peso netto: 0.13 kg Pack/Colli: 1

Description Descrizione	Methacrylate structure Struttura in metacrilato	System Sistema	Code Codice
Single ceiling bracket small size	Matte White - 9010 Bianco Opaco - 9010	Single	R11L01 1000
Rosone per lampada singola versione mini	Matte Black - 9005 Nero Opaco - 9005		R11L01 2000
	Coppery Bronze Bronzo Ramato		R11L01 3500
	Chrome Cromo		R11L01 4000
	Matte Champagne Champagne Opaco		R11L01 4500



Recessed Canopy

Recessed Micro



Ø 3.5 cm
Ø 1.37"

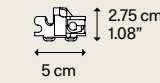

5 cm
1.96"



Min 0.7 cm - 0.27"
Max 2.4 cm - 0.94"

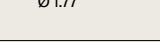

Ø 4.5 cm
Ø 1.77"

Net weight/Peso netto: 0.025 kg Pack/Colli: 1

Description Descrizione	Methacrylate structure Struttura in metacrilato	System Sistema	Code Codice
Recessed bracket for single lamp max capacity 3.5 kg	Matte White - 9010 Bianco Opaco - 9010	Recessed	R01L01 1000
Rosone da incasso per lampada singola portata max 3.5 kg	Matte Black - 9005 Nero Opaco - 9005		R01L01 2000
	Chrome Cromo		R01L01 4000

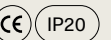

Single Canopy

Single Standard



Ø 12.5 cm
Ø 4.92"

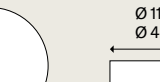

Ø 11 cm
Ø 4.33"

Net weight/Peso netto: 0.4 kg Pack/Colli: 1

Description Descrizione	Metal structure Struttura in metallo	System Sistema	Code Codice
Single ceiling bracket standard size	Matte White - 9010 Bianco Opaco - 9010	Single	R03L01 1000
Rosone per lampada singola versione standard			

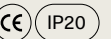

Wall Bracket

Wall Standard



Ø 8 cm
Ø 3.15"

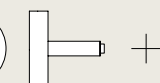

8 cm
3.15"

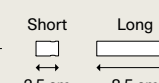

Short
2.5 cm
0.98"

Long
8.5 cm
3.34"

Net weight/Peso netto: 0.8 kg Pack/Colli: 1

Description Descrizione	Metal structure Struttura in metallo	System Sistema	Code Codice
Wall bracket for suspension modular system	Chrome Cromo	Wall	R09L01 4000
Supporto a parete per sistema modulare a sospensione			



RECESSED MICRO ► Suitable for ceilings up to 2.4 cm - 0.94" thickness. WALL STANDARD ► Both accessories in the two available lengths are supplied in the box with the wall bracket.

RECESSED MICRO ► Adatta per soffitti fino a 2.4 cm - 0.94" di spessore. WALL STANDARD ► Entrambi gli accessori nelle due diverse lunghezze sono inclusi nella confezione con il supporto a parete.

Multiple canopies

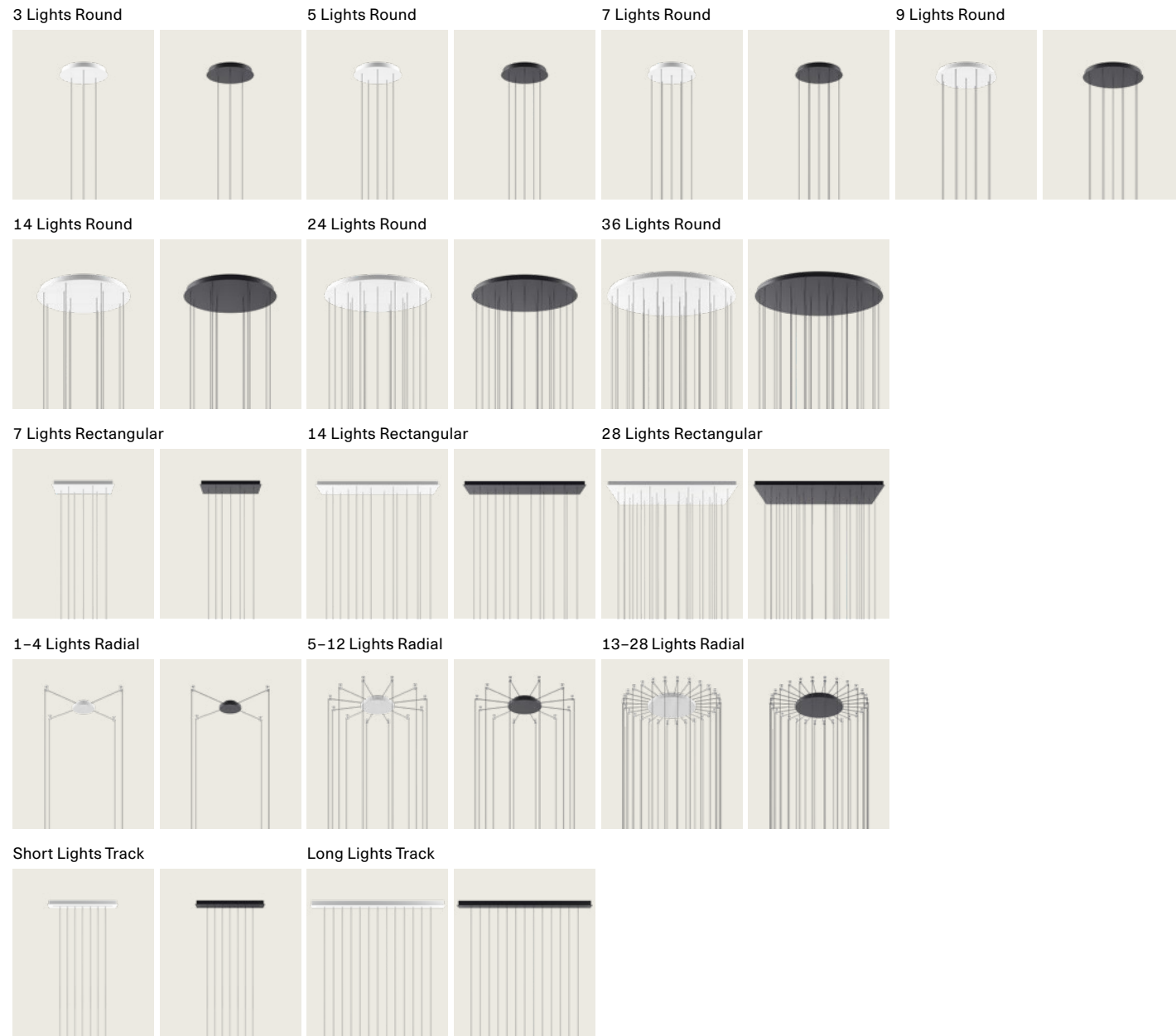

Cluster System

3 Lights Round

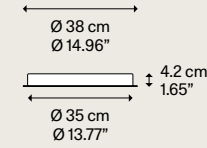
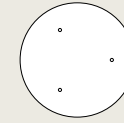

Net weight/Peso netto: 3.55 kg Pack/Colli: 1

Description
Descrizione
Round canopy
for 3 suspensions
Rosone circolare
per 3 sospensioni

Metal structure
Struttura in metallo
● Matte White - 9010
Bianco Opaco - 9010
● Matte Black - 9005
Nero Opaco - 9005

System
Sistema
Cluster

Code
Codice
R04L03 1000
R04L03 2000



5 Lights Round

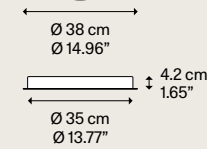
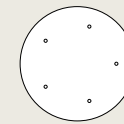

Net weight/Peso netto: 3.55 kg Pack/Colli: 1

Description
Descrizione
Round canopy
for 5 suspensions
Rosone circolare
per 5 sospensioni

Metal structure
Struttura in metallo
● Matte White - 9010
Bianco Opaco - 9010
● Matte Black - 9005
Nero Opaco - 9005

System
Sistema
Cluster

Code
Codice
R04L05 1000
R04L05 2000



7 Lights Round

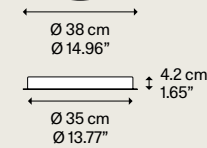
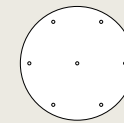

Net weight/Peso netto: 3.55 kg Pack/Colli: 1

Description
Descrizione
Round canopy
for 7 suspensions
Rosone circolare
per 7 sospensioni

Metal structure
Struttura in metallo
● Matte White - 9010
Bianco Opaco - 9010
● Matte Black - 9005
Nero Opaco - 9005

System
Sistema
Cluster

Code
Codice
R04L07 1000
R04L07 2000



9 Lights Round

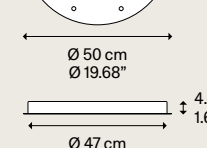
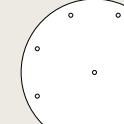

Net weight/Peso netto: 5.80 kg Pack/Colli: 1

Description
Descrizione
Round canopy
for 9 suspensions
Rosone circolare
per 9 sospensioni

Metal structure
Struttura in metallo
● Matte White - 9010
Bianco Opaco - 9010
● Matte Black - 9005
Nero Opaco - 9005

System
Sistema
Cluster

Code
Codice
R04L09 1000
R04L09 2000



Cluster System

14 Lights Round

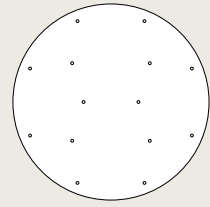

Ø 74 cm
Ø 29.13"

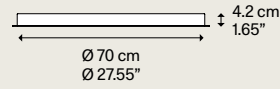

Net weight/Peso netto: 14.14 kg

Pack/Colli: 1

Description Descrizione	Metal structure Struttura in metallo	System Sistema	Code Codice
Round canopy for 14 suspensions	● Matte White – 9010 Bianco Opaco – 9010	Cluster	R04L14 1000
Rosone circolare per 14 sospensioni	● Matte Black – 9005 Nero Opaco – 9005		R04L14 2000

24 Lights Round

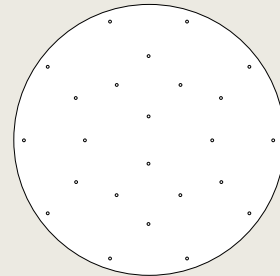

Ø 100 cm
Ø 39.37"

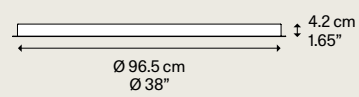

Net weight/Peso netto: 23.5 kg

Pack/Colli: 1

Description Descrizione	Metal structure Struttura in metallo	System Sistema	Code Codice
Round canopy for 24 suspensions	● Matte White – 9010 Bianco Opaco – 9010	Cluster	R04L24 1000
Rosone circolare per 24 sospensioni	● Matte Black – 9005 Nero Opaco – 9005		R04L24 2000

36 Lights Round

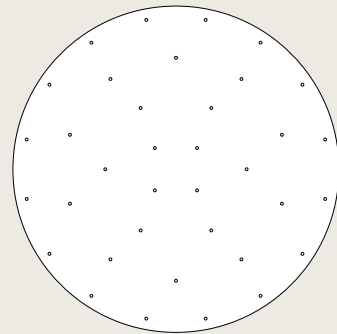

Ø 120 cm
Ø 47.24"

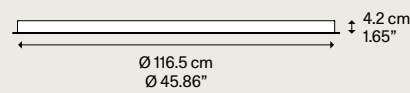

Net weight/Peso netto: 32.7 kg

Pack/Colli: 1

Description Descrizione	Metal structure Struttura in metallo	System Sistema	Code Codice
Round canopy for 36 suspensions	● Matte White – 9010 Bianco Opaco – 9010	Cluster	R04L36 1000
Rosone circolare per 36 sospensioni	● Matte Black – 9005 Nero Opaco – 9005		R04L36 2000

Cluster System

7 Lights Rectangular

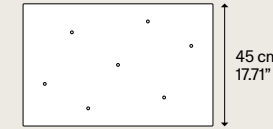

45 cm
17.71"

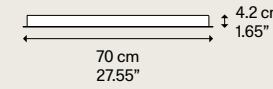

Net weight/Peso netto: 9.89 kg

Pack/Colli: 1

Description Descrizione	Metal structure Struttura in metallo	System Sistema	Code Codice
Rectangular canopy for 7 suspensions	● Matte White – 9010 Bianco Opaco – 9010	Cluster	R05L07 1000
Rosone rettangolare per 7 sospensioni	● Matte Black – 9005 Nero Opaco – 9005		R05L07 2000

14 Lights Rectangular

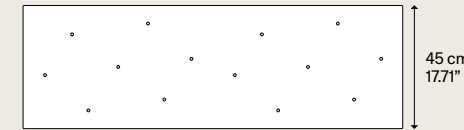

45 cm
17.71"

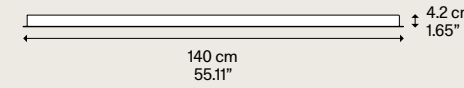

Net weight/Peso netto: 17.1 kg

Pack/Colli: 1

Description Descrizione	Metal structure Struttura in metallo	System Sistema	Code Codice
Rectangular canopy for 14 suspensions	● Matte White – 9010 Bianco Opaco – 9010	Cluster	R05L14 1000
Rosone rettangolare per 14 sospensioni	● Matte Black – 9005 Nero Opaco – 9005		R05L14 2000

28 Lights Rectangular

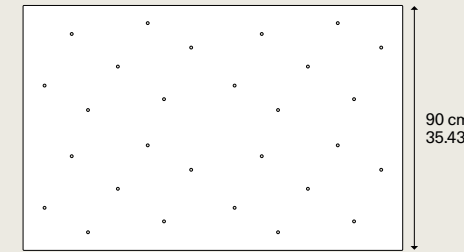

90 cm
35.43"

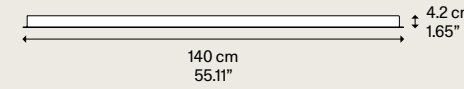

Net weight/Peso netto: 31.1 kg

Pack/Colli: 1

Description Descrizione	Metal structure Struttura in metallo	System Sistema	Code Codice
Rectangular canopy for 28 suspensions	● Matte White – 9010 Bianco Opaco – 9010	Cluster	R05L28 1000
Rosone rettangolare per 28 sospensioni	● Matte Black – 9005 Nero Opaco – 9005		R05L28 2000

Radial System

1–4 Lights Radial



Ø 16.5 cm
Ø 6.49"

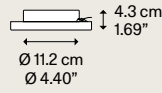

Ø 11.2 cm
Ø 4.40"

Description Descrizione	Metal structure Struttura in metallo	System Sistema	Code Codice
Radial canopy max 4 suspension	● Matte White – 9010 Bianco Opaco – 9010	Radial	R10L04 1000
Rosone radiale max 4 sospensioni	● Matte Black – 9005 Nero Opaco – 9005		R10L04 2000
Radial Swag Kit not included			
Radial Swag Kit non incluso			

Net weight/Peso netto: 0.35 kg

Pack/Colli: 1



5–12 Lights Radial

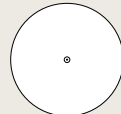

Ø 25 cm
Ø 9.84"

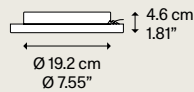

Ø 19.2 cm
Ø 7.55"

Radial canopy max 12 suspension	● Matte White – 9010 Bianco Opaco – 9010	Radial	R10L12 1000
Rosone radiale max 12 sospensioni	● Matte Black – 9005 Nero Opaco – 9005		R10L12 2000
Radial Swag Kit not included			
Radial Swag Kit non incluso			

Net weight/Peso netto: 1.05 kg

Pack/Colli: 1



13–28 Lights Radial

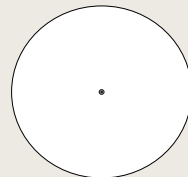

Ø 36 cm
Ø 14.17"

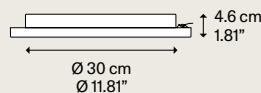

Ø 30 cm
Ø 11.81"

Radial canopy max 28 suspension	● Matte White – 9010 Bianco Opaco – 9010	Radial	R10L28 1000
Rosone radiale max 28 sospensioni	● Matte Black – 9005 Nero Opaco – 9005		R10L28 2000
Radial Swag Kit not included			
Radial Swag Kit non incluso			

Net weight/Peso netto: 3.35 kg

Pack/Colli: 1



Radial System

Swag Kit for Radial Canopy

Ø 2 cm
Ø 0.78"



3 cm
1.18"

Description Descrizione	Polycarbonate structure Struttura in policarbonato	System Sistema	Code Codice
Wall and ceiling anchor for Radial System power cable max Ø 7 mm – 0.27" max capacity 5 kg	● Clear Trasparente	Radial	999A4 00
Cilindro di decentramento per Sistema Radiale cavo elettrico max Ø 7 mm – 0.27" Portata max 5 kg			

Net weight/Peso netto: 0.02 kg

Pack/Colli: 1



Track System

Short Lights Track

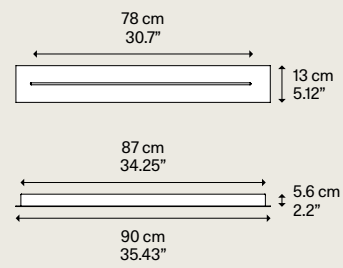

Description Descrizione	Structure finish Finitura struttura	System Sistema	Code Codice
Multiple linear track standard version max 7 suspensions	● Matte White – 9010 Bianco Opaco – 9010	Track	R08L07 1000
	● Matte Black – 9005 Nero Opaco – 9005		R08L07 2000
Binario lineare multiplo versione standard max 7 sospensioni			

Net weight/Peso netto: 5.5 kg

Pack/Colli: 1



Track System

Long Lights Track

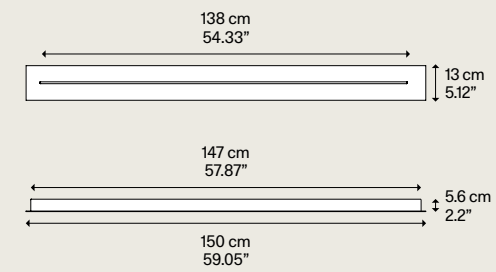

Description Descrizione	Structure finish Finitura struttura	System Sistema	Code Codice
Multiple linear track standard version max 11 suspensions	● Matte White – 9010 Bianco Opaco – 9010	Track	R08L11 1000
	● Matte Black – 9005 Nero Opaco – 9005		R08L11 2000
Binario lineare multiplo versione standard max 11 sospensioni			

Net weight/Peso netto: 8.8 kg

Pack/Colli: 1



Short Lights Track

Maximum quantity Quantità massima		Maximum quantity Quantità massima	
Suspension aligned Sospensione allineata		Staggered suspension Sospensione sfalsata	
Max 7	mod. A–Tube	Max 7	mod. A–Tube
Max 6	mod. A–Tube Nano	Max 6	mod. A–Tube Nano
Max 6	mod. A–Tube Nano Duo	Max 6	mod. A–Tube Nano Duo
Max 6	mod. IVY I	Max 7	mod. IVY I
Max 5	mod. Jefferson	Max 6	mod. Jefferson
Max 4	mod. JIM cylinder	Max 7	mod. JIM cylinder
Max 3	mod. JIM cone	Max 5	mod. JIM cone
Max 3	mod. JIM bell	Max 5	mod. JIM bell
Max 4	mod. Kelly Cluster	Max 7	mod. Kelly Cluster
Max 7	mod. Nostalgia small	Max 7	mod. Nostalgia small
Max 4	mod. Nostalgia medium	Max 7	mod. Nostalgia medium
Max 3	mod. Nostalgia large	Max 5	mod. Nostalgia large
Max 7	mod. Rain	Max 7	mod. Rain
Max 3	mod. Random	Max 5	mod. Random
Max 7	mod. Random Solo 12	Max 7	mod. Random Solo 12
Max 6	mod. Random Solo 14	Max 7	mod. Random Solo 14
Max 4	mod. Random Solo 18	Max 7	mod. Random Solo 18
Max 4	mod. Random Solo 23	Max 7	mod. Random Solo 23
Max 3	mod. Random Solo 28	Max 6	mod. Random Solo 28
Max 7	mod. Spider	Max 7	mod. Spider
Max 6	mod. Volum 14	Max 7	mod. Volum 14
Max 4	mod. Volum 22	Max 7	mod. Volum 22
Max 3	mod. Volum 29	Max 5	mod. Volum 29

Long Lights Track

Maximum quantity Quantità massima		Maximum quantity Quantità massima	
Suspension aligned Sospensione allineata		Staggered suspension Sospensione sfalsata	
Max 11	mod. A–Tube	Max 11	mod. A–Tube
Max 10	mod. A–Tube Nano	Max 10	mod. A–Tube Nano
Max 10	mod. A–Tube Nano Duo	Max 10	mod. A–Tube Nano Duo
Max 10	mod. IVY I	Max 11	mod. IVY I
Max 8	mod. Jefferson	Max 10	mod. Jefferson
Max 8	mod. JIM cylinder	Max 11	mod. JIM cylinder
Max 5	mod. JIM cone	Max 9	mod. JIM cone
Max 5	mod. JIM bell	Max 9	mod. JIM bell
Max 8	mod. Kelly Cluster	Max 11	mod. Kelly Cluster
Max 11	mod. Nostalgia small	Max 11	mod. Nostalgia small
Max 7	mod. Nostalgia medium	Max 11	mod. Nostalgia medium
Max 5	mod. Nostalgia large	Max 9	mod. Nostalgia large
Max 11	mod. Rain	Max 11	mod. Rain
Max 5	mod. Random	Max 9	mod. Random
Max 11	mod. Random Solo 12	Max 11	mod. Random Solo 12
Max 10	mod. Random Solo 14	Max 11	mod. Random Solo 14
Max 8	mod. Random Solo 18	Max 11	mod. Random Solo 18
Max 6	mod. Random Solo 23	Max 11	mod. Random Solo 23
Max 6	mod. Random Solo 28	Max 10	mod. Random Solo 28
Max 11	mod. Spider	Max 11	mod. Spider
Max 10	mod. Volum 14	Max 11	mod. Volum 14
Max 7	mod. Volum 22	Max 11	mod. Volum 22
Max 5	mod. Volum 29	Max 9	mod. Volum 29

Finishes

Colours, materials, and finishes enhance the versatile and eclectic character of the brand. From timeless to bolder tones, Lodes finishes make the lamps dialogue with one another while allowing to express different décor moods. The broad range of finished coupled with the flexibility offered by Lodes canopies ensures that, having started from the standard elements, users can build a personal composition to suit their creative and technical requirements.

I colori, i materiali e le finiture esaltano il carattere versatile ed eclettico del brand. Spaziando dai toni senza tempo a quelli più audaci, le finiture Lodes favoriscono l'interazione e il dialogo tra le lampade, dando espressione a vari mood d'arredo. La varietà della gamma di finiture e la flessibilità offerta dai rosoni Lodes consentono all'utente di partire da elementi standard per personalizzare combinazioni diverse a seconda delle proprie esigenze creative e tecniche.



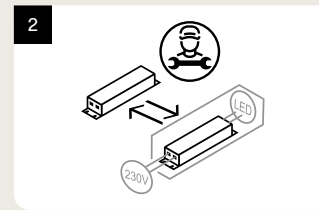
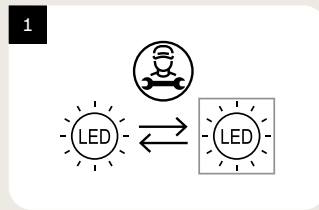

The LED-only light source contained in this fixture must only be replaced by the manufacturer, its support service or similarly qualified personnel. ● EN

The LED driver contained in this fixture must only be replaced by the manufacturer, its support service or similarly qualified personnel. ● EN

La sorgente luminosa, esclusivamente LED, contenuta in questo apparecchio deve essere sostituita solo dal costruttore o dal suo servizio di assistenza o da personale altrettanto qualificato. ● IT

Il driver LED contenuto in questo apparecchio deve essere sostituito solo dal costruttore o dal suo servizio di assistenza o da personale altrettanto qualificato. ● IT

La source lumineuse, exclusivement à LED et contenue dans cet appareil, doit être remplacée uniquement par le fabricant ou par son service après-vente ou encore par un personnel tout aussi qualifié. ● FR

Le driver à LED contenu dans cet appareil doit être remplacé uniquement par le fabricant ou par son service après-vente ou encore par un personnel tout aussi qualifié. ● FR

Das in diesem Geräte enthaltene Leuchtmittel, ausschließlich LED, darf nur vom Hersteller oder dessen Kundendienst oder vergleichbar qualifiziertes Personal ersetzt werden. ● DE

Der in diesem Gerät enthaltene LED-Treiber darf nur vom Hersteller oder dessen Kundendienst oder vergleichbar qualifiziertes Personal ersetzt werden. ● DE

La fuente luminosa exclusivamente LED de este aparato la debe sustituir solamente el fabricante, el Servicio de Asistencia o personal igualmente cualificado. ● ES

El controlador led de este aparato lo debe sustituir solamente el fabricante, el Servicio de Asistencia o personal igualmente cualificado. ● ES

Источник света, являющийся только светодиодом, который находится внутри этого светильника, должен заменяться только производителем или его службой поддержки или квалифицированным персоналом. ● RU

Привод светодиода, находящийся внутри этого светильника, должен заменяться только производителем или его службой поддержки или квалифицированным персоналом. ● RU

本照明设备中包含的全LED光源仅可由制造商、其协助服务部门或具备同等资质的合格人员进行更换。● ZH

本照明设备中包含的led驱动器仅可由制造商、其协助服务部门或具备同等资质的合格人员进行更换。● ZH

Pag.	Spec sheet	Product name (A-Z)	Category	Kelvin	Energy Class	Ecodesign Regulation
056	070	A-Tube Nano	Cluster suspension lamp	2700 K 3000 K	D	1 2
074	083	A-Tube Nano Duo	Cluster suspension lamp	2700 K	D	1 2
354	361	Aile	Wall lamp	2700 K 3000 K	E	1
298	303	Blow	Table lamp	2700 K	C	1 2
404	410	Bugia	Ceiling lamp	2700 K 3000 K	F	1
304	317	Croma	Floor lamp	from 2200 K to 3200 K	E	1 2
288	297	Easy Peasy	Cordless table lamp	from 2700 K to 3300 K	D	1
022	037	Elara	Suspension lamp	2700 K	D + E	1 2
022	037	Elara	Suspension lamp	3000 K	D + F	1 2
274	287	Hover	Floor lamp, Table lamp	2700 K	C	1
038	053 054	IVY	Cluster suspension lamp, Suspension lamp, Central cluster suspension lamp	2700 K	D	1 2
038	053 054	IVY	Cluster suspension lamp, Suspension lamp, Central cluster suspension lamp	3000 K	C	1 2
228	237	Jefferson	Cluster suspension lamp	2700 K	D	1 2
134	149	Kelly	Wall lamp	2700 K	F	1
124	133	Kelly Cluster	Cluster suspension lamp	2700 K	C	1 2
418	423	Laser	Wall lamp	2700 K 3000 K	F	1
424	429	Make-Up	Wall lamp, Ceiling lamp	3000 K	F	1
338	352	Nautilus	Wall lamp	2700 K 3000 K	F	1
338	352	Nautilus Mini	Wall lamp	2700 K 3000 K	G	1
338	353	Nautilus	Ceiling lamp	2700 K 3000 K	F	1
338	353	Nautilus Spot	Ceiling lamp	2700 K 3000 K	F	1
238	249	Nostalgia	Cluster suspension lamp	2700 K	C	1 2
412	417	Pin-Up	Wall lamp, Ceiling lamp	2700 K 3000 K	E	1
388	395	Puzzle	Wall lamp, Ceiling lamp	2700 K 3000 K	F	1
362	374	Puzzle Mega	Wall lamp, Ceiling lamp	2700 K 3000 K	F	1
378	387	Puzzle Round	Wall lamp, Ceiling lamp	2700 K 3000 K	F	1
094	106	Rain	Cluster suspension lamp	2700 K 3000 K	C	1 2
188	203	Random	Cluster suspension lamp	2700 K 3000 K	D	1 2
204	223	Random Solo	Cluster suspension lamp	2700 K 3000 K	D	1 2
252	261	Sky-Fall	Suspension lamp	2700 K 3000 K	E	1 2
108	122	Spider	Cluster suspension lamp	2700 K 3000 K	C	1 2
108	123	Spider	Ceiling lamp	2700 K 3000 K	F	1
328	337	Tidal	Ceiling lamp	2700 K 3000 K	B	1 2

Art. 1 **Recital**
Unless otherwise provided for in a separate written agreement between the parties, every sale of products of Lodes S.r.l., VAT 02992370276 (hereinafter, "the Seller") is governed by the following General Conditions of Sale that must be considered as an essential part of this agreement and shall be deemed to have been accepted by the Buyer even though the latter has not signed them. Any clause unilaterally added by the Buyer in the documentation signed by it and / or in its correspondence, being against or in any case in addition to the general conditions or to those specific expressly approved in writing by the Seller, shall be deemed as not written and shall be of no effect.

Art. 2 **Completion of the sale, quantities and prices**
The sale is deemed to be completed once the Seller gives the written order confirmation also by fax and / or email or when deliveries are commenced in cases where the immediate delivery of the supply is requested, also in consideration of changes occurred and then accepted by the customer. The prices agreed are understood for products delivered ex works of the Seller and do not include services and accessory charges (such as VAT, special packaging, transport and installation costs, and/or assemblages and so on).

Art. 3 **Delivery, risk transfer and transport**
Products are delivered to the Buyer at the Seller's plant or at another place indicated in writing by the Seller, and the risk transfer takes place with the delivery of the goods to the first carrier or Buyer in the events of collection of goods directly carried out by the latter. The products always travel at the Buyer's sole risk also when the carrier is selected and appointed by the Seller, being the latter freed from all responsibilities after having delivered the products to the carrier, this delivery is deemed to all effects being carried out directly by the said Buyer. The delivery terms agreed are to be understood as indicative. If the Seller is responsible for delay of delivery for a period of up to 60 days, the Buyer is not entitled either to refuse the supply or to request the termination of the agreement and / or the compensation for any damages. If the delay in delivery exceeds 60 days, the Buyer is entitled to request – by registered letter – the cancellation of the order and the reimbursement of the advances if paid. In any event, the Seller shall not be liable for and / or direct and indirect damages of any nature and for any reason due to the delay or the failure to carry out the supply.

Art. 4 **Reservation of title**
The Buyer acquires property rights over the goods with the full payment of the price invoiced of the supplies but it takes the risks thereof as of the delivery.

Art. 5 **Products features and conditions of use**
Unless otherwise expressly agreed in writing by the parties, the conditions for using of the products are those communicated or in any case resulting from the drawings and technical specifications of the Seller, if any, or as described in the website www.lodes.com/en/in-relation-to-products. The quality levels of products are the standard quality levels of the Sellers, indicated in the relevant specifications as described on the Seller's website. It is always the Buyer's responsibility to identify and notify the Seller of the conditions of use of products before technically defining them. Failing any particular instructions from the Buyer, the Seller considers as usual conditions of use those it considered or described in its designs and technical documentation.

Art. 6 **Warranties**
The products delivered are covered by a warranty for defects in material and manufacture for a period of 24 months as of the delivery if the Buyer is a natural person, otherwise the warranty period will be of 12 months as of the delivery. The Seller shall replace

the products delivered in this warranty period being faulty due to factory defects or in alternative, at its discretion, pay the Buyer an amount equal to the price already invoiced of the said products, being expressly excluded and waived any other right or claim by the Buyer also as compensation for direct and / or indirect damages or cost repayment borne by it (such as recovery, technical assistance, recalling costs, etc.). The Seller will anticipate the delivery of the replaced product, invoicing it regularly. Successively, when the product arrive to the Seller's warehouse, the latter will credit the amount of the defective product. The transport's costs will be paid by the Seller. Should the defected item be returned in an inadequate non-original packaging, with damages connected to the transport, The Seller will not credit any amount to the Buyer, and it will return the product to the sender at his own expenses. If the replacement was made for alleged defects in material and manufacture, but after the control carried out by the Seller, it is considered

(i) unfounded, due to the absence of defects; (ii) further damaged by insufficient packaging in the return transport (iii) spoiled by tampering made by the Buyer, all transportation costs and the entire value of the product will be charged to the latter. Any defectiveness or non-compliance of products shall be reported by the Buyer by writing to the Seller – in order to be valid – within 8 days from receipt of goods; any hidden defects shall be reported by the Buyer by writing to the Seller – always in order to be valid – within 8 days as of the relevant discovery. It being understood that the Seller will not be responsible for any defect even though hidden, being notified in writing, after 24 months of the delivery of goods. The warranty does not apply where the defects identified are due to the Buyer's negligence and / or to the use of products being not compliant with the information and explanations in any case gave by the Seller, technical provisions, to incorrect design, application, assembly or manufacture of the facilities in which they are installed, to incorrect maintenance carried out by unauthorized personnel, to improper cleaning since it is made with materials and manners being not suitable, to incorrect storage, handling and transport, to improper or imprudent use, also in the event of electrical system and its capacity being not suitable, or to circumstances that in any case cannot be related to the production defectiveness by the Seller. Every single product of the Seller corresponds to the mark laid down by the European Community with Directive 93 / 68 (extension of Directive 73 / 23) to confirm, with a mark recognized all over Europe, that the lights have undergone the electrical safety test required by European standards EN-60598-1-2 II ed. + CEI EN 60598-1 IV ed. corresponding to Italian standards CEI 34-21 + CEI 34-23, electrical safety standards referred to by all institutions, including the IMQ. The products indicated with the logo UL and / or ETL corresponds to the standards UL 1598 / CAN / USA C22.2 No.250.0 o UL 153.

Art. 7 **Buyer's Obligations**
The Buyer is required to immediately take delivery of the goods given by the Seller to the carrier, or – where otherwise agreed – to timely collect them at the Seller's plant on the date on which the Seller communicates, by any means, that the goods are ready. Where the Buyer delays the collection of the production for a period exceeding 10 days, in addition to the payment of price it shall pay the Seller a proper compensation equal to 2% per day of the price invoiced for storing such products. The Buyer shall carry out the payments normally, in accordance with the terms and conditions specified in the invoice. For late payments it will be accrued by default without need of further notification interest under Legislative Decree no. 231 / 2002. In the event of payment delays, the Seller is entitled to immediately suspend any supply, even though it has concluded other agreements with the same Buyer. The failure to pay within the terms agreed will cause in any event the loss of favourable terms for the Buyer.

Art. 8 **Replacement of the Product**
If a product is returned for commercial reasons or for a mistake in the order made by the Buyer, the Seller will retain an amount equal to the 20% of the total price as cost for reconditioning the product. If the returned product had already been used and / or it has been returned in an inadequate original packaging, with consequent transport damages, the Seller will not credit to the Buyer any amount and it will return the product to the sender at his own expenses. Only the articles in the catalogue and in the price list in force at the time of the request will be taken into consideration. Transport's costs are always charged to the Buyer. The repair of damaged products will be authorized only if the damage has been caused by the Buyer. The Buyer, once accepted repair costs, will take care of returning the damaged product to the Seller's warehouse and it will pay the costs of transporting the repaired product.

Art. 9 **Force majeure**
If the Seller is unable to comply with the agreement due to force majeure or beyond its control events, the deadlines set for the supply are automatically extended for a period in which these effects continue. Where the obstacle to comply with the agreement is longer than 6 months, both parties may request the termination of the agreement and, in such event, the Seller repay the Buyer the advances received, if any, releasing itself from any additional obligation on it.

Art. 10 **Agreement**
In the event of execution of a specific agreement signed by the parties, the said agreement together with its Annexes provides for and summarizes the obligations validly undertaken by the parties and being binding for them. The fulfilment by the parties will be subject to effective evaluation of the actual performance of the contractual tasks and duties to be carried out in good faith, with honesty and fairness. These General Conditions of Sale shall apply to the agreement, unless otherwise provided in writing by the parties or expressly provided in the said agreement.

Art. 11 **Privacy Policy**
The Seller will use the data received from the Buyer in accordance with the provisions of the article 13 of EU Regulation 2016 / 679 of 27 April 2016 (GDPR). For more information are available at the following link: www.lodes.com/en/terms-and-conditions/.

Art. 12 **Disputes**
Any dispute which may arise concerning the signing, validity, interpretation, performance, amendment and termination of the agreement or of these General Conditions of Sale will be settled according to principles and rule set forth in Article 13 below.

Art. 13 **Jurisdiction and Applicable Law**
The Court of Milan, Italy, shall be held exclusively competent, being any other court of competent jurisdiction expressly excluded, and the Italian Law shall be applicable.

Art. 14 **Website**
These General Conditions of Sale are those indicated on the website www.lodes.com/en/and may be printed and reproduced on paper. The Seller undertakes to update the website www.lodes.com/en/ by publishing on it the version of the General Conditions of Sale as amended from time to time.

Art. 1 **Premessa**
Salvo deroga risultante da apposito accordo scritto tra le parti, ogni compravendita di prodotti di Lodes S.r.l., P.IVA 02992370276 (di seguito: "Venditore") è regolata dalle seguenti Condizioni Generali di Vendita che costituiscono parte essenziale del contratto e che si intendono pertanto accettate dal Compratore ancorché dallo stesso non sottoscritte. Qualsiasi clausola unilateralmente apposta dal Compratore nei documenti da lui sottoscritti e / o nella sua corrispondenza, che sia contraria o comunque in aggiunta alle seguenti condizioni generali od a quelle speciali espressamente approvate per iscritto dal Venditore, si intende come non scritta ed è priva di ogni effetto.

Art. 2 **Perfezionamento della compravendita, quantitativi e prezzi**
La compravendita si intende perfezionata con la conferma d'ordine scritta del Venditore anche a mezzo fax e / o posta elettronica o con l'inizio delle consegne per i casi in cui è stata richiesta l'immediata consegna della fornitura anche in presenza di modifiche intervenute e quindi accettate dal cliente. I prezzi concordati si intendono per prodotti consegnati franco stabilimento del Venditore e non comprendono prestazioni ed oneri accessori (quali IVA, imballo speciale, spese di trasporto, di installazione e / o montaggi e così via).

Art. 3 **Consegna, trasferimento del rischio e trasporto**
La merce viene consegnata al Compratore presso lo stabilimento del Venditore o in altro sito dallo stesso indicato per iscritto, ed il trasferimento del rischio avviene con la consegna della stessa al primo vettore o al Compratore nelle ipotesi di ritiro della merce da quest'ultimo direttamente eseguita. La merce viaggia sempre a rischio esclusivo del Compratore anche quando il vettore dovesse essere scelto ed incaricato dal Venditore, essendo quest'ultimo liberato da ogni responsabilità con la consegna dei prodotti al vettore, che ad ogni effetto si intende eseguita a mani dallo stesso Compratore. I termini di consegna pattuiti si intendono indicativi. In caso di ritardo nella consegna imputabile al Venditore per un periodo fino a 60 gg il Compratore non ha il diritto di rifiutare la fornitura, né di richiedere la risoluzione del contratto e / o il risarcimento di alcun danno. Se il ritardo nella consegna supera il termine di 60 gg il Compratore ha la facoltà di richiedere – con lettera raccomandata – l'annullamento dell'ordine e la restituzione degli anticipi eventualmente versati. Resta in ogni caso escluso qualsivoglia obbligo del Venditore di risarcimento danni diretti e / o indiretti di qualsiasi natura e per qualsiasi ragione, in dipendenza del ritardo ovvero della mancata esecuzione della fornitura.

Art. 4 **Riserva di proprietà**
Il Compratore acquista la proprietà della merce solo con il pagamento integrale del prezzo fatturato delle forniture ma ne assume i rischi dal momento della consegna.

Art. 5 **Caratteristiche dei prodotti e condizioni di utilizzo**
Salvo diverso ed espresso accordo scritto tra le parti, i parametri funzionali dei prodotti sono quelli espressi comunicati o comunque risultanti nei disegni e specifiche tecniche del Venditore se esistenti o su quanto indicato sul sito web www.lodes.com relativamente ai prodotti. I livelli di qualità dei prodotti forniti sono quelli standard del Venditore, evidenziati nelle relative specifiche o su quanto indicato e desumibile sul sito web del Venditore. È onere del Compratore individuare e comunicare al Venditore le condizioni di utilizzo dei prodotti prima della relativa definizione tecnica. In mancanza di indicazioni da parte del Compratore il Venditore considera condizioni di utilizzo quelle di prassi dallo stesso considerate o esplicitate nei propri disegni e documentazione tecnica.

Art. 6 **Garanzie**
I prodotti forniti sono coperti da garanzia per difetti di materiale e / o fabbricazione per un periodo di 24 mesi dalla consegna se il Compratore risulta essere una persona fisica, diversamente il periodo di garanzia sarà di 12 mesi dalla consegna. Il Venditore sostituisce i prodotti resi in detto periodo di garanzia e riconosciuti difettosi per vizi d'origine ovvero in alternativa ed a sua scelta accreditata al Compratore una somma pari al prezzo già fatturato dei prodotti stessi, restando espressamente escluso e rinunciato qualsiasi diverso diritto o pretesa del Compratore anche a titolo di risarcimento danni diretti e / o indiretti o di rimborso di costi dallo stesso sostenuti (quali costo di riprese, di assistenza tecnica, di richiamo, ecc.). Il Venditore anticiperà l'invio del prodotto in sostituzione, fatturandolo regolarmente, andando poi ad accreditare l'importo alla riconsegna del prodotto difettoso reso. Le spese di trasporto saranno a carico del Venditore. Qualora l'articolo oggetto del reso venisse riconsegnato in un imballo non originale inadeguato con conseguenti danni da trasporto, il Venditore non accrediterà al Compratore alcun importo e rinverrà al mittente, a sue spese il prodotto. Qualora il reso venisse effettuato per presunti vizi d'origine ma dopo il controllo effettuato dal Venditore lo stesso venisse ritenuto (i) infondato, per assenza di vizi; (ii) ulteriormente danneggiato da insufficiente imballaggio nel trasporto di ritorno (iii) viziato da manomissione posta in essere dal Compratore, verranno addebitati a quest'ultimo tutti i costi di trasporto nonché l'intero valore del prodotto. Eventuali difettosità o non conformità dei prodotti devono essere segnalate dal Compratore per iscritto al Venditore – a pena di decadenza – entro e non oltre 8 gg dalla data di ricevimento della merce; eventuali difetti occulti devono essere segnalati dal Compratore per iscritto al Venditore – sempre a pena di decadenza – entro 8 gg dalla relativa scoperta. Resta inteso che il Venditore non sarà responsabile per alcun vizio ancorché occulto, comunicato per iscritto, oltre 24 mesi dalla consegna della merce. La garanzia non opera ove i difetti rilevati siano imputabili a negligenza del Compratore e / o ad impiego dei prodotti non conforme con le informazioni e le spiegazioni in ogni caso fornite dal Venditore, alle prescrizioni tecniche, ad errata progettazione, applicazione, montaggio o fabbricazione delle strutture ove sono installati, ad errata manutenzione operata da personale non autorizzato, a pulizia impropria in quanto effettuata con modalità o materiali non idonei, ad errato magazzinaggio, movimentazione e trasporto, ad uso improprio od incauto, anche in caso di impianto elettrico e portata dello stesso non idonea, ovvero a circostanze che comunque non possono ricollegarsi a difettosità di produzione da parte del Venditore. Ogni singolo prodotto del Venditore è conforme alla marcatura richiesta dalla Comunità Europea con la direttiva 93 / 68 (ampliamento della direttiva 73 / 23) per confermare con una marcatura riconosciuta in tutta Europa, che le lampade sono state sottoposte alle prove di sicurezza elettrica richieste dalle norme Europee EN-60598-1-2 II ed. + CEI EN 60598-1 IV ed. corrispondenti norme italiane CEI 34-21 + CEI 34-23, norme per la sicurezza elettrica a cui fanno riferimento tutti gli istituti, compreso l'IMQ. I prodotti indicati con il marchio UL e / o ETL sono conformi alla normativa UL 1598 / CAN / USA C22.2 No.250.0 o UL 153.

Art. 7 **Obblighi del Compratore**
Il Compratore è tenuto a prendere immediatamente in consegna i prodotti affidati dal Venditore al vettore, ovvero – se diversamente concordato – a puntualmente ritirarli presso lo stabilimento del Venditore alla data di comunicazione di merce pronta che potrà avvenire con ogni mezzo da parte del Venditore. Ove il Compratore ritardi il ritiro dei prodotti per un periodo superiore a 10 gg, oltre al pagamento del prezzo deve corrispondere al Venditore un adeguato compenso pari al 2% al giorno dell'importo fatturato per il magazzinaggio degli stessi. Il Compratore deve effettuare i pagamenti normalmente, con le modalità e nei termini precisati in fattura. Sui ritardati pagamenti decorreranno, di pieno diritto e senza necessità di costituzione in mora, gli

interessi di cui al D.lgs. n. 231 / 2002. In caso di ritardo dei pagamenti il Venditore ha diritto a sospendere immediatamente ogni fornitura, anche se dipendente da altri contratti con lo stesso Compratore. Il mancato pagamento nei termini pattuiti comporta in ogni caso la decadenza del Compratore dal beneficio del termine.

Art. 8 **Resi**
In caso di reso commerciale o in caso di reso per errore del Compratore, il Venditore tratterà un importo pari al 20% minimo del totale a titolo di costo di ricondizionamento dell'articolo. Qualora l'articolo oggetto del reso fosse già stato utilizzato e / o venisse riconsegnato in un imballo non originale inadeguato, con conseguenti danni da trasporto, il Venditore non accrediterà al Compratore nessun importo e rinverrà al mittente, a sue spese, il reso. Verranno presi in considerazione solamente gli articoli presenti nel catalogo e nel listino in vigore al momento della richiesta. Le spese di trasporto sono sempre a carico del Compratore. I resi per riparazione vanno autorizzati solo se la causa del danno è dipesa dal Compratore che dopo aver accettato il costo di riparazione si occuperà a proprie spese di rispedire l'articolo danneggiato in sede e si accollerà poi i costi relativi al trasporto del prodotto riparato.

Art. 9 **Forza maggiore**
Qualora il Venditore sia impossibilitato a rispettare il contratto per cause di forza maggiore o comunque indipendenti dalla sua volontà, i termini previsti per l'esecuzione della fornitura sono automaticamente prorogati per un periodo equivalente al perdurare degli effetti di tali cause. Qualora la causa impeditiva continui per più di 6 mesi entrambe le parti possono chiedere la risoluzione del contratto ed in tal caso il Venditore restituisce al Compratore gli anticipi eventualmente ricevuti, con esclusione di ogni e qualsiasi onere ulteriore a suo carico.

Art. 10 **Contratto**
In caso di sottoscrizione di apposito contratto lo stesso con i suoi allegati contiene e riassume le obbligazioni validamente assunte dalle parti e per esse vincolanti. L'adempimento delle parti sarà oggetto di valutazione dell'effettiva esecuzione dei compiti e doveri contrattuali, da effettuarsi in buona fede, onestà e con equità. Le presenti Condizioni Generali di Vendita si applicheranno al contratto salvo deroga risultante da atto scritto o in esso contratto esplicitamente prevista.

Art. 11 **Tattamento dei Dati Personali**
Il Venditore utilizzerà i dati ricevuti dal Compratore conformemente alle disposizioni vigenti in materia di Privacy secondo l'art. 13 del Regolamento Europeo 2016 / 679 (GDPR). Maggiori informazioni sono disponibili al seguente link: www.lodes.com/area-legale/.

Art. 12 **Controversie**
Qualora dovesse verificarsi una qualsivoglia controversia avente ad oggetto la formazione, validità, interpretazione, esecuzione, modifica e risoluzione del contratto o delle presenti Condizioni Generali di Vendita, questa sarà risolta secondo i principi e le regole indicate nell'articolo 13 che segue.

Art. 13 **Foro competente e legge applicabile**
Foro esclusivamente competente sarà quello di Milano con esplicita esclusione di ogni altro foro alternativamente competente, e la legge applicabile quella italiana.

Art. 14 **Sito Web**
Le presenti Condizioni Generali di Vendita, sono quelle risultanti sul sito web www.lodes.com e sono stampabili e riproducibili su supporto cartaceo. Il Venditore si impegna ad aggiornare il sito web www.lodes.com mediante la pubblicazione sullo stesso della versione di Condizioni Generali di Vendita di volta in volta modificata.

Head offices & showroom

Lodes, via Pialoi 32,
30020 Marcon (Venezia) Italy
T +39 041 45 69 266
General information
info@lodes.com

Lodes USA LLC
560 Springfield Avenue,
Suite B – Westfield,
NJ 07090 – USA
D 201 903 0020
usa@lodes.com

Lodes Milan showroom

via della Moscova 33,
Cortile della Seta
20121 Milano (MI) Italy
T +39 02 4940 0999
milano@lodes.com

Lodes 2023
Collection Catalogue

*Art direction
and graphic design*
Multi Form

Images
Bruger Studio

Photography
Mattia Balsamini
(pag. 002–007)
Studio Pointer

Copywritings
Lodes

*Colour separation
and printing*
Grafiche Antiga

